



MRF

Test Booklet Code

JEE-MAIN 2018

B

PAPER - 1 : PHYSICS, MATHEMATICS & CHEMISTRY

Do not open this Test Booklet until you are asked to do so.

Read carefully the Instructions on the Back Cover of this Test Booklet.

Important Instructions:

1. Immediately fill in the particulars on this page of the Test Booklet with **only Black Ball Point Pen** provided in the examination hall.
2. The Answer Sheet is kept inside this Test Booklet. When you are directed to open the Test Booklet, take out the Answer Sheet and fill in the particulars carefully.
3. The test is of **3 hours** duration.
4. The Test Booklet consists of **90** questions. The maximum marks are **360**.
5. There are **three** parts in the question paper A, B, C consisting of, **Physics, Mathematics and Chemistry** having 30 questions in each part of equal weightage. Each question is allotted **4 (four)** marks for each correct response.
6. *Candidates will be awarded marks as stated above in instruction No. 5 for correct response of each question. 1/4 (one fourth) marks of the total marks allotted to the question (i.e., 1 mark) will be deducted for indicating incorrect response of each question. No deduction from the total score will be made if no response is indicated for an item in the answer sheet.*
7. There is only one correct response for each question. Filling up more than one response in any question will be treated as wrong response and marks for wrong response will be deducted accordingly as per instruction 6 above.
8. For writing particulars/ marking responses on **Side-1** and **Side-2** of the Answer Sheet **use only Black Ball Point Pen** provided in the examination hall.
9. No candidate is allowed to carry any textual material, printed or written, bits of papers, pager, mobile phone, any electronic device, etc., except the Admit Card inside the examination room/hall.
10. Rough work is to be done on the space provided for this purpose in the Test Booklet only. This space is given at the bottom of each page and in **four** pages (Pages **20–23**) at the end of the booklet.
11. On completion of the test, the candidate must hand over the Answer Sheet to the Invigilator on duty in the Room / Hall. **However, the candidates are allowed to take away this Test Booklet with them.**
12. The CODE for this Booklet is **B**. Make sure that the CODE printed on **Side–2** of the Answer Sheet is same as that on this Booklet. Also tally the serial number of the Test Booklet and Answer Sheet are the same as that on this booklet. In case of discrepancy, the candidate should immediately report the matter to the invigilator for replacement of both the Test Booklet and the Answer Sheet.
13. **Do not fold or make any stray marks on the Answer Sheet.**

Name of the Candidate (in Capital letters) : _____

Roll Number : in figures

--	--	--	--	--	--	--	--

: in words _____

Examination Centre Number :

--	--	--	--	--	--

Name of Examination Centre (in Capital letters) : _____

Candidate's Signature : _____

1. Invigilator's Signature : _____

2. Invigilator's Signature : _____

Read the following instructions carefully :

1. The candidates should fill in the required particulars on the Test Booklet and Answer Sheet (*Side-1*) with **Black Ball Point Pen**.
2. For writing/marketing particulars on *Side-2* of the Answer Sheet, use **Black Ball Point Pen only**.
3. The candidates should not write their Roll Numbers anywhere else (except in the specified space) on the Test Booklet/Answer Sheet.
4. Out of the four options given for each question, only one option is the correct answer.
5. For each **incorrect response**, $\frac{1}{4}$ (**one-fourth**) of the total marks allotted to the question (i.e., 1 mark) will be deducted from the total score. **No deduction** from the total score, however, will be made **if no response** is indicated for an item in the Answer Sheet.
6. Handle the Test Booklet and Answer Sheet with care, *as under no circumstances (except for discrepancy in Test Booklet Code and Answer Sheet Code), another set will be provided.*
7. The candidates are not allowed to do any rough work or writing work on the Answer Sheet. All calculations/writing works are to be done in the space provided for this purpose in the Test Booklet itself, marked 'Space for Rough Work'. This space is given at the bottom of each page and in **four** pages (Pages 20 – 23) at the end of the booklet.
8. On completion of the test, the candidates must hand over the Answer Sheet to the Invigilator on duty in the Room/Hall. **However, the candidates are allowed to take away this Test Booklet with them.**
9. Each candidate must show on demand his/her Admit Card to the Invigilator.
10. No candidate, without special permission of the Superintendent or Invigilator, should leave his/her seat.
11. The candidates should not leave the Examination Hall without handing over their Answer Sheet to the Invigilator on duty and sign the Attendance Sheet again. Cases where a candidate has not signed the Attendance Sheet second time will be deemed not to have handed over the Answer Sheet and dealt with as an unfair means case. **The candidates are also required to put their left hand THUMB impression in the space provided in the Attendance Sheet.**
12. Use of Electronic/Manual Calculator and any Electronic Item like mobile phone, pager etc. is prohibited.
13. The candidates are governed by all Rules and Regulations of the Examination body with regard to their conduct in the Examination Hall. All cases of unfair means will be dealt with as per Rules and Regulations of the Examination body.
14. No part of the Test Booklet and Answer Sheet shall be detached under any circumstances.
15. **Candidates are not allowed to carry any textual material, printed or written, bits of papers, pager, mobile phone, electronic device or any other material except the Admit Card inside the examination room/hall.**

QUESTIONS AND SOLUTIONS

PART- A : PHYSICS

ALL THE GRAPHS/DIAGRAMS GIVEN ARE SCHEMATIC AND NOT DRAWN TO SCALE

1. It is found that if a neutron suffers an elastic collinear collision with deuterium at rest, fractional loss of its energy is p_d ; while for its similar collision with carbon nucleus at rest, fractional loss of energy is p_c . The values of p_d and p_c are respectively:

- (1) (0, 0) (2) (0, 1) (3) (.89, .28) (4) (.28, .89)

1. (3)

L.M.C

$$mv_1 + 2m V_2 = mV_0$$

$$V_1 + 2V_2 = V_0 \quad \dots(1)$$

$$e = \frac{V_2 - V_1}{V_0} = 1$$

$$V_2 - V_1 = V_0 \quad \dots(2)$$

On solving $V_2 = \frac{2V_0}{3}$ and $V_1 = -\frac{V_0}{3}$

$$\text{Final KE of neutron} = \frac{1}{2} mV_1^2 = \frac{1}{2} m \left(\frac{V_0}{3} \right)^2 = \frac{1}{9} \left(\frac{1}{2} mV_0^2 \right)$$

$$\text{Loss in KE} = \frac{8}{9} \left(\frac{1}{2} mV_0^2 \right)$$

$$\text{Fractional loss } P_d = \frac{8}{9} = 0.89$$

Similarly collision between N and C

$$mV_1 + 12m.V_2 = mV_0$$

$$V_1 + 12V_2 = V_0 \quad \dots(1)$$

$$V_2 - V_1 = V_0 \quad \dots(2)$$

On Solving $V_2 = \frac{2V_0}{13}$ and $V_1 = -\frac{11V_0}{13}$

$$\text{Final KE} = \frac{1}{2} m \left(\frac{11V_0}{13} \right)^2 = \frac{121}{169} \left(\frac{1}{2} mV_0^2 \right)$$

$$\text{Loss in KE} = \frac{48}{169} \left(\frac{1}{2} mV_0^2 \right)$$

$$\text{Fractional loss } P_c = \frac{48}{169} = 0.28$$

2. The mass of a hydrogen molecule is 3.32×10^{-27} kg. If 10^{23} hydrogen molecules strike, per second, a fixed wall of area 2 cm^2 at an angle of 45° to the normal, and rebound elastically with a speed of 10^3 m/s, then the pressure on the wall is nearly:

- (1) $2.35 \times 10^2 \text{ N/m}^2$ (2) $4.70 \times 10^2 \text{ N/m}^2$
 (3) $2.35 \times 10^3 \text{ N/m}^2$ (4) $4.70 \times 10^3 \text{ N/m}^2$

2. (1)

Change in momentum of one molecule

$$\Delta P_1 = 2 mv \cos 45^\circ = \sqrt{2} mv$$

$$\text{Force } F = \frac{\Delta P}{\Delta t} = n \times \Delta P_1$$

Where $n \rightarrow$ no. of molecules incident per unit time

$$\text{Pressure } P = \frac{\text{Force}}{\text{Area}}$$

$$P = \frac{n \times \sqrt{2}mv}{A}$$

$$P = \frac{10^{23} \times \sqrt{2} \times 3.32 \times 10^{-27} \times 10^3}{2 \times 10^{-4}}$$

$$P = \frac{3.32}{1.41} \times 10^3 = 2.35 \times 10^3 \text{ N/m}^2$$

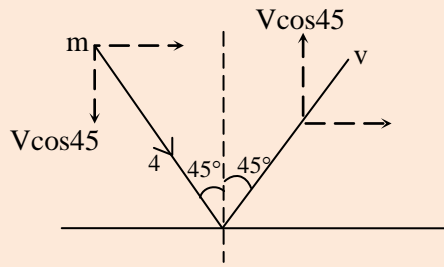

3. A solid sphere of radius \$r\$ made of a soft material of bulk modulus \$K\$ is surrounded by a liquid in a cylindrical container. A massless piston of area \$a\$ floats on the surface of the liquid, covering entire cross section of cylindrical container. When a mass \$m\$ is placed on the surface of the piston to compress the liquid, the fractional decrement in the radius of the sphere, \$\left(\frac{dr}{r}\right)\$, is:

- (1) \$\frac{mg}{3Ka}\$ (2) \$\frac{mg}{Ka}\$ (3) \$\frac{Ka}{mg}\$ (4) \$\frac{Ka}{3mg}\$

3. (1) Bulk modulus

$$K = \left(\frac{-dP}{dV/V} \right)$$

$$\frac{dV}{V} = \frac{dP}{K}$$

$$\frac{dV}{V} = \frac{mg}{Ka} \quad \dots (1)$$

$$V = \frac{4}{3} \pi r^3$$

$$\frac{dV}{V} = 3 \frac{dr}{r} \quad \dots (2)$$

From eq. (1) and (2)

$$\frac{dr}{r} = \frac{mg}{3Ka}$$

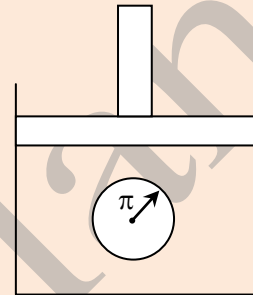

4. Two batteries with e.m.f. \$12 \text{ V}\$ and \$13 \text{ V}\$ are connected in parallel across a load resistor of \$10 \text{ }\Omega\$. The internal resistances of the two batteries are \$1 \text{ }\Omega\$ and \$2 \text{ }\Omega\$ respectively. The voltage across the load lies between.

- (1) \$11.4 \text{ V}\$ and \$11.5 \text{ V}\$ (2) \$11.7 \text{ V}\$ and \$11.8 \text{ V}\$
 (3) \$11.6 \text{ V}\$ and \$11.7 \text{ V}\$ (4) \$11.5 \text{ V}\$ and \$11.6 \text{ V}\$

4. (4)

$$E_{eq} = \frac{\frac{E_1}{r_1} + \frac{E_2}{r_2}}{\frac{1}{r_1} + \frac{1}{r_2}} = \frac{\frac{12}{1} + \frac{13}{2}}{\frac{1}{1} + \frac{1}{2}} = \frac{37}{3}$$

$$r_{eq} = \frac{1 \times 2}{1 + 2} = \frac{2}{3} \text{ }\Omega$$

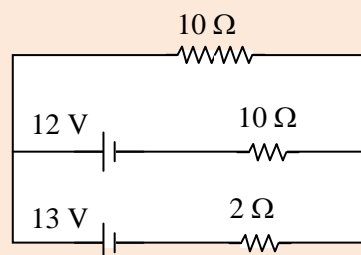

$$i = \frac{E_{eq}}{R + r_{eq}} = \frac{\frac{37}{3}}{10 + \frac{2}{3}} = \frac{37}{32} \text{ amp}$$

$$\Delta V = iR = \frac{37}{32} \times 10 = \frac{185}{16} = 11.56$$

5. A particle is moving in a circular path of radius a under the action of an attractive potential $U = -\frac{k}{2r^2}$. Its total energy is:

- (1) Zero (2) $-\frac{3k}{2a^2}$ (3) $-\frac{k}{4a^2}$ (4) $\frac{k}{2a^2}$

5. (1)

$$U = -\frac{k}{2r^2}$$

$$F = -\frac{du}{dr} = +\frac{k}{2} \left(\frac{-2}{r^3} \right)$$

$$F = -\frac{k}{r^3}$$

$$\text{Centripetal force } \frac{mv^2}{r} = \frac{k}{r^3}$$

$$mv^2 = \frac{k}{r^2}$$

$$kE = \frac{1}{2}mv^2 = \frac{k}{2r^2}$$

$$\text{Total Energy } E = K + U = 0$$

6. Two masses $m_1 = 5 \text{ kg}$ and $m_2 = 10 \text{ kg}$, connected by an inextensible string over a frictionless pulley, are moving as shown in the figure. The coefficient of friction of horizontal surface is 0.15. The minimum weight m that should be put on top of m_2 to stop the motion is:

- (1) 43.3 kg (2) 10.3 kg
(3) 18.3 (4) 27.3 kg

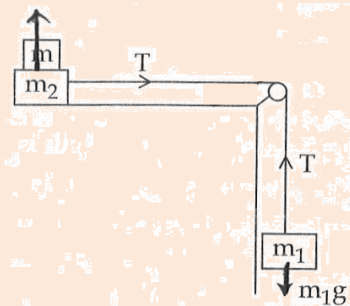

6. (4)
at equilibrium
 $fr = T = m_1g$
 $fr_{\max} = \mu (m_2 + m)g$
 $\mu(10 + m)g = 5g$

$$10 + m = \frac{5}{0.15}$$

$$10 + m = \frac{100}{3}$$

$$m = \frac{70}{3} \text{ kg} = 23.3 \text{ kg. The minimum weight in the options is } 27.3 \text{ kg.}$$

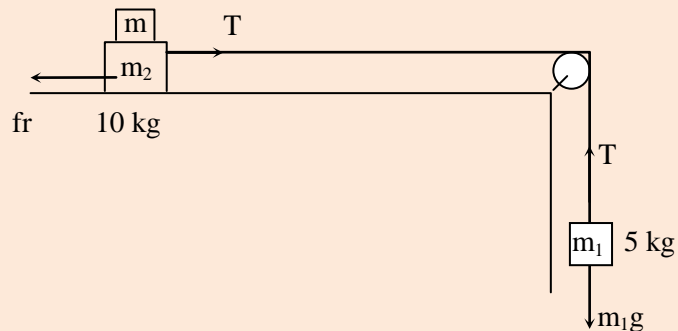

7. If the series limit frequency of the Lyman series is ν_L , then the series limit frequency of the Pfund series is:

- (1) $\nu_L/16$ (2) $\nu_L/25$ (3) $25 \nu_L$ (4) $16 \nu_L$

7. (2)

Series limit is

$$L_{\text{yman}} : \infty \rightarrow 1$$

$$P_{\text{fund}} : \infty \rightarrow 5$$

$$v_{\text{Lyman}} = RC$$

$$v_{\text{Pfund}} = \frac{RC}{25}$$

8. Unpolarized light of intensity I passes through an ideal polarizer A. Another identical polarizer B is placed behind A. the intensity of light beyond B is found to be $\frac{I}{2}$. Now another identical polarizer C is placed between A and B. The intensity beyond B is now found to be $\frac{I}{8}$. The angle between polarizer A and C is:

(1) 45°

(2) 60°

(3) 0°

(4) 30°

8. (1)

Unpolarized light passes the A

$$\Rightarrow I_{\text{after A}} = \frac{I}{2}$$

$$I_{\text{after B}} = \frac{I}{2} \text{ given}$$

$\Rightarrow \angle$ between A and B is 90°

Let A and C have θ

$$I_{\text{after C}} = \frac{I}{2} \cos^2 \theta$$

$$I_{\text{after B}} = \frac{I}{2} \cos^2 \theta \cos^2 (90 - \theta) = \frac{I}{8} \quad \therefore [\cos \theta \sin \theta]^2 = \frac{1}{4}$$

$$\left[\frac{\sin 2\theta}{2} \right]^2 = \frac{1}{4}$$

$$\sin 2\theta = 1 \Rightarrow \theta = 45^\circ$$

9. An electron from various excited states of hydrogen atom emit radiation to come to the ground state. Let λ_n, λ_g be the de Broglie wavelength of the electron in the n^{th} state and the ground state respectively. Let Λ_n be the wavelength of the emitted photon in the transition from the n^{th} state to the ground state. For large n , (A, B are constants)

(1) $\Lambda_n^2 \approx A + B\lambda_n^2$

(2) $\Lambda_n^2 \approx \lambda$

(3) $\Lambda_n \approx A + \frac{B}{\lambda_n^2}$

(4) $\Lambda_n \approx A + B\lambda_n$

9. (3)

$$mvr = \frac{nh}{2\pi}$$

$$\lambda_{\text{de Broglie}} = \frac{h}{p} = \frac{2\pi r}{n}$$

$$\lambda_n = \frac{2\pi r_n}{n}$$

$$\lambda_g = \frac{2\pi r_1}{1} = 2\pi r_1 \quad \therefore \frac{\lambda_n}{\lambda_g} = \frac{r_n}{nr_1} = n$$

$$\frac{1}{\lambda} = R \left[1 - \frac{1}{n^2} \right]$$

$$\Rightarrow \frac{1}{\lambda_n} = \frac{n^2}{R(n^2 - 1)} = \frac{1}{R} \left[\frac{\lambda_n^2}{\lambda_n^2 - \lambda_g^2} \right]$$

$$= \frac{1}{R} \left[\frac{1}{1 - \left(\frac{\lambda_g}{\lambda_n} \right)^2} \right] \approx \frac{1}{R} \left[1 + \left(\frac{\lambda_g}{\lambda_n} \right)^2 \right] = A + \frac{B}{\lambda_n^2}$$

10. The reading of the ammeter for a silicon diode in the given circuit is:

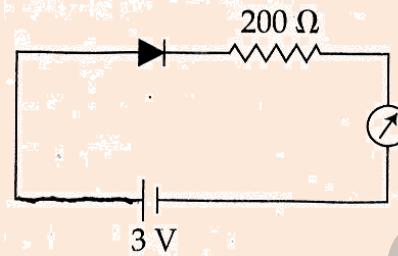

- (1) 11.5 mA (2) 13.5 mA (3) 0 (4) 15 mA

10. (1)

Knowledge based

Si diode has forward bias resistance

200 Ω at 2 V

400 Ω at 1 V

\Rightarrow here $R_{fb} < 200 \Omega$... at 3V

11. An electron, a proton and an alpha particle having the same kinetic energy are moving in circular orbits of radii r_e , r_p , r_α respectively in a uniform magnetic field B. The relation between r_e , r_p , r_α is:

- (1) $r_e < r_p < r_\alpha$ (2) $r_e < r_\alpha < r_p$ (3) $r_e > r_p = r_\alpha$ (4) $r_e < r_p = r_\alpha$

11. (4)

$$r = \frac{mv}{qB} = \frac{p}{qB}$$

$$K = \frac{1}{2} mv^2 \quad \dots \text{same}$$

$$= \frac{p^2}{2m} \Rightarrow p \propto \sqrt{m}$$

B same

$$\therefore r \propto \frac{p}{q} \text{ or } \frac{\sqrt{m}}{q}$$

$$q_p = q_e$$

$$q_\alpha = 2q_p$$

$$m_p = 1836 m_e$$

$$m_\alpha = 4 m_p$$

12. A parallel plate capacitor of capacitance 90 pF is connected to a battery of emf 20V. If a dielectric material of dielectric constant $K = \frac{5}{3}$ is inserted between the plates, the magnitude of the induced charge will be :

- (1) 2.4 nC (2) 0.9 nC (3) 1.2 nC (4) 0.3 nC

12. (3)

Battery remains connected as dielectric is introduced

So E, V unchanged

$$q_0 = C_0 V$$

$$q = k C_0 V$$

Induced charge $q' = q - q_0$

$$= C_0 V (k - 1)$$

$$= 90 \times 10^{-12} \times 20 \left(\frac{5}{3} - 1 \right) = 1.2 \text{ nc}$$

13. For an RLC circuit driven with voltage of amplitude v_m and frequency $\omega_0 = \frac{1}{\sqrt{LC}}$ the current

exhibits resonance. The quality factor, Q is given by:

(1) $\frac{R}{(\omega_0 C)}$

(2) $\frac{CR}{\omega_0}$

(3) $\frac{\omega_0 L}{R}$

(4) $\frac{\omega_0 R}{L}$

13. (3)

Quantity factor

$$Q = \frac{\omega_0 L}{R} \quad \dots \text{ from theory}$$

14. A telephonic communication service is working at carrier frequency of 10 GHz. Only 10% of it is utilized for transmission. How

(1) 2×10^5

(2) 2×10^6

(3) 2×10^3

(4) 2×10^4

14. (1)

$$\text{No of channels} = \frac{\text{carrier frequency} \times 0.1}{\text{channel bandwidth}} = \frac{0.1 \times 10 \times 10^9}{5 \times 10^3} = 2 \times 10^5$$

15. a granite rod of 60 cm length is clamed at its middle point and is set into longitudinal vibrations.

The density of granite is $2.7 \times 10^3 \text{ kg/m}^3$ and its Young's modulus is $9.27 \times 10^{10} \text{ Pa}$. What will be the fundamental frequency of the longitudinal vibrations?

(1) 10 kHz

(2) 7.5 kHz

(3) 5 kHz

(4) 2.5 kHz

15. (3)

$$v = \sqrt{\frac{Y}{\rho}} \frac{\lambda}{4}$$

$$= \frac{\ell}{2} \Rightarrow \lambda = 2\ell$$

$$\therefore n = \frac{v}{\lambda} = \frac{1}{2\ell} \sqrt{\frac{Y}{\rho}}$$

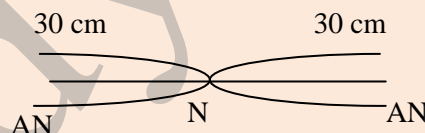

16. Seven identical circular planar disks, each of mass M and radius R are welded symmetrically as shown. The moment of inertia of the arrangement about the axis normal to the plane and passing through the point P is:

(1) $\frac{73}{2} MR^2$

(2) $\frac{181}{2} MR^2$

(3) $\frac{19}{2} MR^2$

(4) $\frac{55}{2} MR^2$

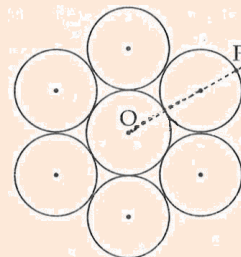

16. (2)

M.I. about origin

$$I_0 = \frac{MR^2}{2} + 6 \left[\frac{MR^2}{2} + M(2R)^2 \right]$$

$$I_0 = \frac{MR^2}{2} + 27MR^2$$

$$I_0 = \frac{55}{2} MR^2$$

$$I_p = I_0 + 7M(3R)^2$$

$$I_p = \frac{55}{2} MR^2 + 63MR^2$$

$$I_p = \frac{181}{2} MR^2$$

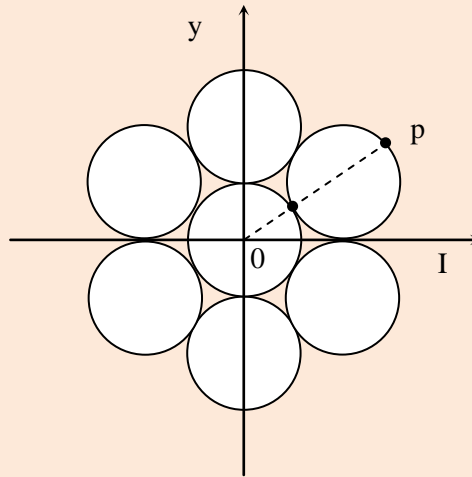

17. Three concentric metal shells A, B and C of respective radii a , b and c ($a < b < c$) have surface charge densities $+\sigma$, $-\sigma$ and $+\sigma$ respectively. The potential of shell B is :

(1) $\frac{\sigma}{\epsilon_0} \left[\frac{b^2 - c^2}{b} + a \right]$

(2) $\frac{\sigma}{\epsilon_0} \left[\frac{b^2 - c^2}{c} + a \right]$

(3) $\frac{\sigma}{\epsilon_0} \left[\frac{a^2 - b^2}{a} + c \right]$

(4) $\frac{\sigma}{\epsilon_0} \left[\frac{a^2 - b^2}{b} + c \right]$

17. (4)

$$V_B = \frac{k(\sigma \times 4\pi a^2)}{b} - \frac{k(\sigma \times 4\pi b^2)}{b} + \frac{k(\sigma \times 4\pi c^2)}{c}$$

$$V_B = \frac{\sigma}{\epsilon_0} \left[\frac{a^2}{b} - b + c \right]$$

$$V_B = \frac{\sigma}{\epsilon_0} \left[\frac{a^2 - b^2}{b} + c \right]$$

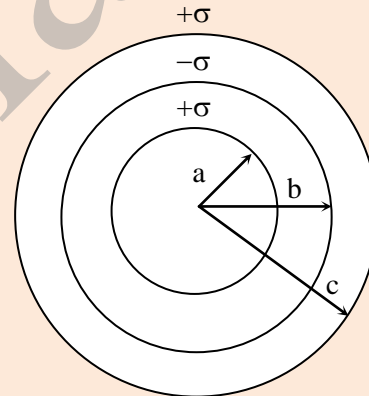

18. In a potentiometer experiment, it is found that no current passes through the galvanometer when the terminals of the cell are connected across 52 cm of the potentiometer wire. If the cell is shunted by a resistance of 5Ω , a balance is found when the cell is connected across 40 cm of the wire. Find the internal resistance of the cell.

(1) 2Ω

(2) 2.5Ω

(3) 1Ω

(4) 1.5Ω

18. (4)

When switch s is opened

$$E = \lambda L_1 \quad \dots \text{(I)}$$

Where λ is potential gradient

$$\text{when switch is closed } E - ir = \lambda L_2 \quad \dots \text{(II)}$$

$$\frac{\text{(II)}}{\text{(I)}} \quad \frac{E - ir}{E} = \frac{L_2}{L_1}$$

$$\text{(I)} \quad \frac{E - ir}{E} = \frac{L_2}{L_1}$$

$$1 - \frac{ir}{E} = \frac{L_2}{L_1}$$

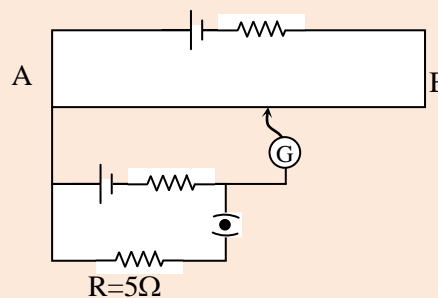

Replace $i = \frac{E}{R+r}$

$$1 - \frac{r}{R+r} = \frac{L_2}{L_1}$$

$$\frac{R}{R+r} = \frac{L_2}{L_1}$$

$$r = R \left(\frac{L_1}{L_2} - 1 \right) = 5 \left(\frac{52}{40} - 1 \right) = 5 \times \frac{12}{40} = 1.5 \Omega$$

19. An EM wave from air enters a medium. The electric fields are $\vec{E}_1 = E_{01} \hat{x} \cos \left[2\pi\nu \left(\frac{z}{c} - t \right) \right]$ in air and $\vec{E}_2 = E_{02} \hat{x} \cos [k(2z - ct)]$ in medium, where the wave number k and frequency ν refer to their values in air. The medium is non-magnetic. If ϵ_{r1} and ϵ_{r2} refer to relative permittivities of air and medium respectively, which of the following options is correct?

- (1) $\frac{\epsilon_{r1}}{\epsilon_{r2}} = \frac{1}{4}$ (2) $\frac{\epsilon_{r1}}{\epsilon_{r2}} = \frac{1}{2}$ (3) $\frac{\epsilon_{r1}}{\epsilon_{r2}} = 4$ (4) $\frac{\epsilon_{r1}}{\epsilon_{r2}} = 2$

19. (1)

$$E_1 = E_{01} \hat{x} \cos \left[2\pi\nu \left(\frac{z}{c} - t \right) \right]$$

$$E_2 = E_{02} \hat{x} \cos [k(2z - ct)] = E_{02} \hat{x} \cos \left[\frac{2\pi}{\lambda} \times c \left(\frac{2z}{c} - t \right) \right]$$

$$= E_{02} \hat{x} \cos \left[2\pi\nu \left(\frac{2z}{c} - t \right) \right]$$

Velocity in new medium

$$V = \frac{c}{2}$$

$$\frac{1}{\sqrt{\mu_0 \epsilon_2}} = \frac{1}{2} \times \frac{1}{\sqrt{\mu_0 \epsilon_1}}$$

$$\boxed{\frac{\epsilon_1}{\epsilon_2} = \frac{1}{4}} \quad \left\{ \text{relative permittivity } \epsilon_r = \frac{\epsilon}{\epsilon_0} \right\}$$

20. The angular width of the central maximum in a single slit diffraction pattern is 60° . The width of the slit is $1 \mu\text{m}$. The slit is illuminated by monochromatic plane waves. If another slit of same width is made near it, Young's fringes can be observed on a screen placed at a distance 50 cm from the slits. If the observed fringe width is 1 cm , what is slit separation distance? (i.e., distance between the centres of each slit.)

- (1) $75 \mu\text{m}$ (2) $100 \mu\text{m}$ (3) $25 \mu\text{m}$ (4) $50 \mu\text{m}$

20. (3)

$$2\alpha = 60^\circ$$

$$a = 1 \mu\text{m}$$

$$D = 50 \text{ cm}$$

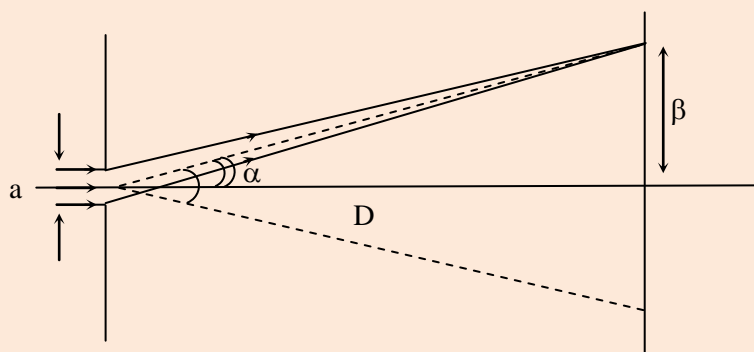

Cond. for minima

$$\text{Path diff } \Delta x = a \sin \theta = n\lambda$$

$$a = 1\mu\text{m and } \theta = 30^\circ \text{ and } n = 1$$

$$\lambda = 0.5\mu\text{m}$$

If same setup is used for YDSE

$$\text{Fringe width } \beta = \frac{\lambda D}{d} = 1 \text{ cm}$$

$$d = \frac{0.5 \times 10^{-6} \times 0.5}{0.01} = 25\mu\text{m}$$

$$d = 25\mu\text{m}$$

21. A silver atom in a solid oscillates in simple harmonic motion in some direction with a frequency of 10^{12} /sec. What is the force constant of the bonds connecting one atom with the other? (Mole wt. of silver = 108 and Avagadro number = 6.02×10^{23} gm mole⁻¹)
 (1) 2.2 N/m (2) 5.5 N/m (3) 6.4 N/m (4) 7.1 N/m

21. (4)

$$\text{Frequency } f = \frac{1}{T} = \frac{1}{2\pi} \sqrt{\frac{k}{m}}$$

$$k = m (2\pi f)^2$$

Mass of 1 atom

$$m = \frac{108}{6.02 \times 10^{23}} = 18 \times 10^{-23} \text{ gm} = 18 \times 10^{-26} \text{ kg}$$

$$k = 18 \times 10^{-26} (2\pi \times 10^{12})^2 = 4\pi^2 \times 18 \times 10^{-2}$$

$$k = 7.2 \text{ N/m} \quad (\pi^2 = 10)$$

22. From a uniform circular disc of radius R and mass 9 M, a small disc of radius $\frac{R}{3}$ is removed as shown in the figure. The moment of inertia of the remaining disc about an axis perpendicular to the plane of the disc and passing through centre of disc is :

- (1) $10 MR^2$ (2) $\frac{37}{9} MR^2$
 (3) $4 MR^2$ (4) $\frac{40}{9} MR^2$

22. (3)

Mass \propto Area, $M \propto R^2$

Mass of portion removed

$$\frac{M_1}{M_0} = \frac{1}{9}, \quad M_1 = \frac{M_0}{9} = M$$

$$I_0 = \frac{9MR^2}{2} - \left[\frac{M \left(\frac{R}{3} \right)^2}{2} + M \left(\frac{2R}{3} \right)^2 \right]$$

$$I_0 = \frac{9MR^2}{2} - \left[\frac{MR^2}{18} + \frac{4MR^2}{9} \right]$$

$$I_0 = \frac{9MR^2}{2} - \left[\frac{9MR^2}{18} \right] = \frac{9MR^2}{2} - \frac{MR^2}{2}$$

$$I_0 = 4MR^2$$

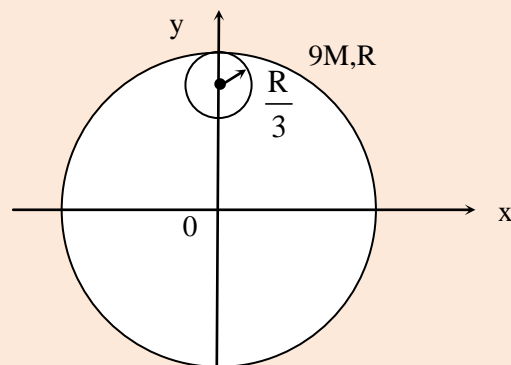
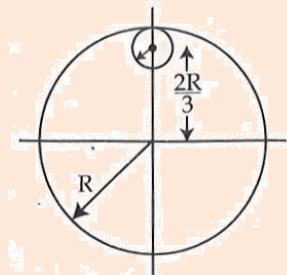

23. In a collinear collision, a particle with an initial speed v_0 strikes a stationary particle of the same mass. If the final total kinetic energy is 50% greater than the original kinetic energy, the magnitude of the relative velocity between the two particles, after collision, is :

- (1) $\frac{v_0}{2}$ (2) $\frac{v_0}{\sqrt{2}}$ (3) $\frac{v_0}{4}$ (4) $\sqrt{2} v_0$

23. (4)

L.M.C.

$$mv_1 + m V_2 = m V_0$$

$$V_1 + V_2 = V_0 \quad \dots \text{(I)}$$

$$\text{Initial kE} = \frac{1}{2} m V_0^2$$

$$\text{final kE} = \frac{1}{2} m V_1^2 + \frac{1}{2} m V_2^2$$

$$\text{final kE} = \frac{3}{2} \text{ initial kE}$$

$$\frac{1}{2} m (V_1^2 + V_2^2) = \frac{3}{2} \left(\frac{1}{2} m V_0^2 \right)$$

$$V_1^2 + V_2^2 = \frac{3}{2} V_0^2 \quad \dots \text{(II)}$$

$$\text{(I)}^2 - \text{(II)}$$

$$2V_1V_2 = -\frac{1}{2} V_0^2 \quad \dots \text{(III)}$$

$$(V_1 - V_2)^2 = (V_1 + V_2)^2 - 4V_1V_2$$

$$(V_1 - V_2)^2 = V_0^2 + V_0^2 = 2V_0^2$$

$$V_{\text{rel}} = |V_1 - V_2| = V_0\sqrt{2}$$

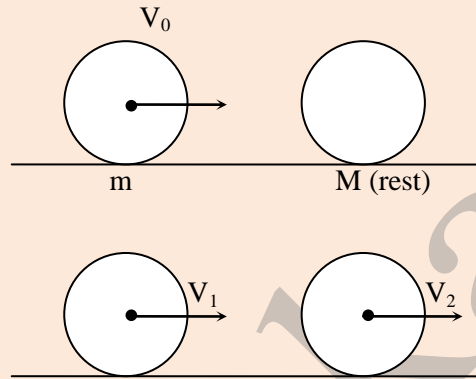

24. The dipole moment of a circular loop carrying a current I , is m and the magnetic field at the centre of the loop is B_1 . When the dipole moment is doubled by keeping the current constant, the magnetic field at the centre of the loop is B_2 . The ratio $\frac{B_1}{B_2}$ is :

- (1) $\sqrt{2}$ (2) $\frac{1}{\sqrt{2}}$ (3) 2 (4) $\sqrt{3}$

24. (1)

Dipole moment $\mu = niA$

$$\mu = i \times \pi R^2$$

If dipole moment is doubled keeping current const.

$$\boxed{R_2 = R_1\sqrt{2}}$$

Magnetic Field at center of loop

$$B = \frac{\mu_0 i}{2R}$$

$$\frac{B_1}{B_2} = \frac{R_2}{R_1} = \frac{\sqrt{2}}{1}$$

25. The density of the material in the shape of a cube is determined by measuring three sides of the cube and its mass. If the relative errors in measuring the mass and length are respectively 1.5% and 1%, the maximum error in determining the density is :

- (1) 4.5 % (2) 6 % (3) 2.5 % (4) 3.5 %

25. (1)

$$\rho = \frac{m}{V} = \frac{m}{\ell^3}$$

$$\begin{aligned} \frac{\Delta \rho}{\rho} \times 100 &= \frac{\Delta m}{m} \times 100 + 3 \frac{\Delta \ell}{\ell} \times 100 \\ &= 1.5 + 3 \times 1 = 1.5 + 3 = 4.5 \end{aligned}$$

26. On interchanging the resistances, the balance point of a meter bridge shifts to the left by 10 cm. The resistance of their series combination is 1 k Ω . How much was the resistance on the left slot before interchanging the resistances?

- (1) 550 Ω (2) 910 Ω (3) 990 Ω (4) 505 Ω

26. (1)

Let balancing length is L

$$\frac{R_1}{R_2} = \frac{L}{100-L} \quad \dots (1)$$

If R_1 and R_2 are interchanged balancing length is (L - 10)

$$\frac{R_2}{R_1} = \frac{L-10}{110-L} \quad \dots (2)$$

From eq. (1) and (2)

$$\frac{L}{100-L} = \frac{100-L}{L-10}$$

$$\Rightarrow L^2 - 10L = 110 \times 100 + L^2 - 210L$$

$$\Rightarrow 200L = 110 \times 100$$

$$L = 55 \text{ cm}$$

$$\frac{R_1}{R_2} = \frac{55}{45} = \frac{11}{9}$$

$$R_1 + R_2 = 1000 \Omega$$

On solving

$$R_1 = 550 \Omega \text{ and } R_2 = 450 \Omega$$

27. In an a.c. circuit, the instantaneous e.m.f. and current are given by

$$e = 100 \sin 30 t$$

$$i = 20 \sin \left(30 t - \frac{\pi}{4} \right)$$

In one cycle of a.c., the average power consumed by the circuit and the wattless current are, respectively :

- (1) $\frac{50}{\sqrt{2}}, 0$ (2) 50, 0 (3) 50, 10 (4) $\frac{1000}{\sqrt{2}}, 10$

27. (4)

$$e = 100 \sin 30 t \quad \therefore e_{\text{rms}} = \frac{100}{\sqrt{2}}$$

$$i = 20 \sin \left(30t - \frac{\pi}{4} \right) \quad \therefore i_{\text{rms}} = \frac{20}{\sqrt{2}}$$

$$P = e_{\text{rms}} \cdot I_{\text{rms}} \cdot \cos \frac{\pi}{4} = \frac{100}{\sqrt{2}} \times \frac{20}{\sqrt{2}} \times \frac{1}{\sqrt{2}} = \frac{2000}{2\sqrt{2}} = \frac{1000}{\sqrt{2}}$$

$$\begin{aligned} \text{Wattless current } I &= I_{\text{rms}} \sin \frac{\pi}{4} \\ &= \frac{20}{\sqrt{2}} \times \frac{1}{\sqrt{2}} = \frac{20}{2} = 10 \end{aligned}$$

28. All the graphs below are intended to represent the same motion. One of them does it incorrectly. Pick it up.

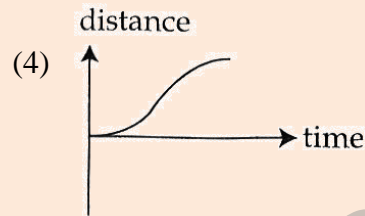
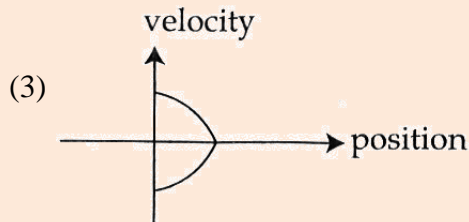
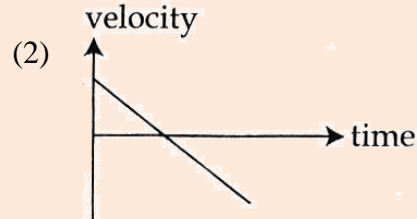
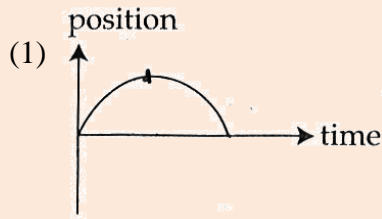

28. (4)

If V Vs t is a straight line with $-ve$ slope $acc = -ve$ const.

Displacement Vs time is a parabola opening downward

Only incorrect option is (4)

Correct distance Vs time graph is

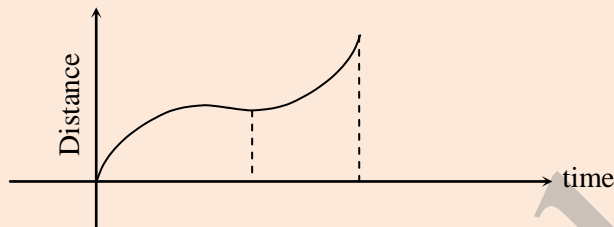

29. Two moles of an ideal monoatomic gas occupies a volume V at 27°C . The gas expands adiabatically to a volume $2V$. Calculate (a) the final temperature of the gas and (b) change in its internal energy.

- (1) (a) 189 K (b) -2.7 kJ (2) (a) 195 K (b) 2.7 kJ
 (3) (a) 189 K (b) 2.7 kJ (4) (a) 195 K (b) -2.7 kJ

29. (1)

$$\gamma = \frac{5}{3} \text{ for monoatomic gas.}$$

$$T_1 = 27^\circ\text{C} = 273 + 27 = 300\text{ K}$$

$$\frac{V_2}{V_1} = 2$$

$$TV^{\gamma-1} = \text{const.}$$

$$T_2 V_2^{\gamma-1} = T_1 V_1^{\gamma-1}$$

$$\frac{T_2}{T_1} = \left(\frac{V_1}{V_2}\right)^{\gamma-1} = \left(\frac{1}{2}\right)^{\frac{5}{3}-1} = \left(\frac{1}{2}\right)^{\frac{2}{3}} = \left(\frac{1}{4}\right)^{\frac{1}{3}} = 0.63$$

$$T_2 = 300 \times 0.63 \quad \therefore T_2 = T_1 \times 0.63$$

$$= 189\text{ K}$$

$$\Delta U = \frac{f}{2} nR\Delta T$$

$$\Delta U = \frac{-3}{2} \times 2 \times 8.3 \times 111$$

$$\boxed{\Delta U = -2.76\text{ kJ.}}$$

(15) VIDYALANKAR : JEE-MAIN 2018 : Question Paper and Solution

30. A particle is moving with a uniform speed in a circular orbit of radius R in a central force inversely proportional to the n^{th} power of R. If the period of rotation of the particle is T, then :

- (1) $T \propto R^{(n+1)/2}$ (2) $T \propto R^{n/2}$ (3) $T \propto R^{3/2}$ for any n (4) $T \propto R^{\frac{n}{2}+1}$

30. (1)

$$\frac{mv^2}{R} = K \cdot \frac{1}{R^n}$$

$$v^2 = K \cdot \frac{R}{mR^n} = K \cdot \frac{1}{m R^{n-1}}$$

$$v = K' \cdot \frac{1}{R^{\frac{(n-1)}{2}}} \quad \left[K' = \sqrt{\frac{k}{m}} \right]$$

$$T = \frac{2\pi R}{v} = \frac{2\pi R \times R^{\frac{n-1}{2}}}{K'} = \frac{2\pi}{K'} \cdot R^{\frac{n+1}{2}}$$

$$\therefore T \propto R^{\frac{n+1}{2}}$$

PART- B : MATHEMATICS

31. If the tangent at (1, 7) to the curve $x^2 = y - 6$ touches the circle $x^2 + y^2 + 16x + 12y + c = 0$, then the value of c is :

- (1) 85 (2) 95 (3) 195 (4) 185

31. (2)

Equation of tangent at (1, 7) to $x^2 = y - 6$ is $2x - y = -5$.

It touches circle $x^2 + y^2 + 16x + 12y + c = 0$.

Hence length of perpendicular from centre (-8, -6) to tangent equals radius of circle.

$$\therefore \frac{|-16 + 6 + 5|}{\sqrt{(2)^2 + (-1)^2}} = \sqrt{64 + 36 - c} \Rightarrow c = 95$$

32. If L_1 is the line of intersection of the planes $2x - 2y + 3z - 2 = 0$, $x - y + z + 1 = 0$ and L_2 is the line of intersection of the planes $x + 2y - z - 3 = 0$, $3x - y + 2z - 1 = 0$, then the distance of the origin from the plane, containing the lines L_1 and L_2 is :

- (1) $\frac{1}{2\sqrt{2}}$ (2) $\frac{1}{\sqrt{2}}$ (3) $\frac{1}{4\sqrt{2}}$ (4) $\frac{1}{3\sqrt{2}}$

32. (4)

$$\begin{vmatrix} \ell & m & n \\ 2 & -2 & 3 \\ 1 & -1 & 1 \end{vmatrix} = \ell + m \leftarrow \text{drs of line } L_1$$

$$\begin{vmatrix} \ell & m & n \\ 1 & 2 & -1 \\ 3 & -1 & 2 \end{vmatrix} = 3\ell - 5m - 7n \leftarrow \text{drs of line } L_2$$

$$\begin{vmatrix} \ell & m & n \\ 1 & 1 & 0 \\ 3 & 5 & -7 \end{vmatrix} = -7\ell - 7m - 8n \leftarrow \text{Normal plane containing line } L_1 \text{ and } L_2$$

For one point of line L_1

$$\begin{cases} 2x - 2y + 3z - 2 = 0 \\ x - y + z = 1 = 0 \\ -2y + 3z = 2 \\ -y + z = -1 \end{cases} \text{ Solving } (0, 5, 4)$$

So, equation of plane is $-7(x - 0) + 7(y - 5) - 8(z - 4) = 0$
 $7x - 7y + 8z + 3 = 0$

$$\text{Distance} = \left| \frac{7 \times 0 - 7 \times 0 + 8 \times 0 + 3}{\sqrt{7^2 + 7^2 + 8^2}} \right| = \frac{1}{3\sqrt{2}}$$

33. If $\alpha, \beta \in \mathbb{C}$ are the distinct roots of the equation $x^2 - x + 1 = 0$, then $\alpha^{101} + \beta^{107}$ is equal to :
 (1) 1 (2) 2 (3) -1 (4) 0

33. (1)

$$x^2 - x + 1 = 0$$

$$x = \frac{1 \pm \sqrt{1 - 4 \times 1 \times 1}}{2 \times 1} = \frac{1 \pm i\sqrt{3}}{2}$$

$$= \frac{1 + i\sqrt{3}}{2}, \quad \frac{1 - i\sqrt{3}}{2}$$

$$= -\frac{-1 - i\sqrt{3}}{2}, \quad -\frac{-1 + i\sqrt{3}}{2}$$

$$\begin{aligned} \alpha^{101} + \beta^{107} &= (-\omega^2)^{101} + (-\omega)^{107} \\ &= -[\omega^{202} + \omega^{107}] \\ &= -[(\omega^3)^{67} \omega + (\omega^3)^{35} \omega^2] \\ &= -[\omega + \omega^2] = 1 \end{aligned}$$

34. Tangents are drawn to the hyperbola $4x^2 - y^2 = 36$ at the points P and Q. If these tangents intersect at the point T(0, 3) then the area (in sq. units) of ΔPTQ is :

- (1) $60\sqrt{3}$ (2) $36\sqrt{5}$ (3) $45\sqrt{5}$ (4) $54\sqrt{3}$

34. (3)

$$4x^2 - y^2 = 36 \Rightarrow \frac{x^2}{9} - \frac{y^2}{36} = 1 \Rightarrow a^2 = 9, \quad b^2 = 36$$

From T(0, 3) tangents are drawn to hyperbola at P and Q.

Hence equation of Chord of contact PQ is

$$\frac{x(0)}{9} - \frac{y(3)}{36} = 1 \Rightarrow y = -12$$

$$\therefore \frac{x^2}{9} - \frac{144}{36} = 1 \Rightarrow x^2 = 45 \Rightarrow x = \pm 3\sqrt{5}$$

Hence P $\equiv (3\sqrt{5}, -12)$ and Q $\equiv (-3\sqrt{5}, -12)$

$$\text{Hence A } (\Delta PQT) \text{ is } \frac{1}{2} \begin{vmatrix} 3\sqrt{5} & -12 & 1 \\ -3\sqrt{5} & -12 & 1 \\ 0 & 3 & 1 \end{vmatrix} = 45\sqrt{5}$$

(17) VIDYALANKAR : JEE-MAIN 2018 : Question Paper and Solution

35. If the curves $y^2 = 6x$, $9x^2 + by^2 = 16$ intersect each other at right angles, then the value of b is :

- (1) 4 (2) $\frac{9}{2}$ (3) 6 (4) $\frac{7}{2}$

35. (2)

$$\begin{array}{l|l} y^2 = 6x & 9x^2 + by^2 = 16 \\ \frac{dy}{dx} = \frac{3}{y} & 18x + 2by \frac{dy}{dx} = 0 \\ & \frac{dy}{dx} = -\frac{9x}{by} \end{array}$$

Let intersection point (x_1, y_1)

$$\left(\frac{dy}{dx}\right)_{(x_1, y_1)} \cdot \left(\frac{dy}{dx}\right)_{(x_1, y_1)} = 1$$

$$\Rightarrow \frac{3}{y_1} \times \left(-\frac{9x_1}{by_1}\right) = -1$$

$$27x_1 = by_1^2$$

$$27x_1 = b(6x_1)$$

$$b = \frac{9}{2}$$

$$[\text{As } (x_1, y_1) \text{ lies on } y^2 = 6x \Rightarrow y_1^2 = 6x_1]$$

36. If the system of linear equations :

$$x + ky + 3z = 0$$

$$3x + ky - 2z = 0$$

$$2x + 4y - 3z = 0$$

has a non-zero solution (x, y, z) , then $\frac{xz}{y^2}$ is equal to :

- (1) -30 (2) 30 (3) -10 (4) 10

36. (4)

$$\text{Non-zero solution} \Rightarrow \Delta = \begin{vmatrix} 1 & k & 3 \\ 3 & k & -2 \\ 2 & 4 & -3 \end{vmatrix} = 0$$

$$\Rightarrow 1 \cdot (-3k + 8) - k(-5) + 3(12 - 2k) = 0$$
$$k = 11$$

$$x + 11y + 3z = 0$$

$$3x + 11y - 2z = 0$$

$$\frac{x}{-22-33} = \frac{y}{-(-2-9)} = \frac{z}{11-33}$$

$$\frac{x}{-55} = \frac{y}{11} = \frac{z}{-22}$$

$$\frac{x}{5} = \frac{y}{-1} = \frac{z}{2} = L \quad (\text{Let})$$

$$\frac{xz}{y^2} = \frac{(5L)(2L)}{(-L)^2} = 10$$

37. Let $S = \{x \in \mathbb{R} : x \geq 0 \text{ and } 2|\sqrt{x} - 3| + \sqrt{x}(\sqrt{x} - 6) + 6 = 0\}$. Then S :

- (1) contains exactly two elements. (2) contains exactly four elements.
(3) is an empty set. (4) contains exactly one element.

37. (1)

$$2|\sqrt{x}-3|+\sqrt{x}(\sqrt{x}-6)+6=0$$

$$2\sqrt{x}-6+x-6\sqrt{x}+6=0 \text{ if } \sqrt{x}>3$$

$$x-4\sqrt{x}=0 \Rightarrow \sqrt{x}(\sqrt{x}-4)=0 \Rightarrow \sqrt{x}=0,4 \Rightarrow \sqrt{x}=4$$

Also, $2(3-\sqrt{x})+\sqrt{x}(\sqrt{x}-6)+6=0$ if $\sqrt{x}<3$

$$6-2\sqrt{x}+x-6\sqrt{x}+6=0$$

$$x-8\sqrt{x}+12=0 \Rightarrow (\sqrt{x})^2-6\sqrt{x}-2\sqrt{x}+12=0$$

$$\therefore (\sqrt{x}-2)(\sqrt{x}-6)=0 \Rightarrow \sqrt{x}=2,6 \Rightarrow \sqrt{x}=2$$

38. If sum of all the solutions of the equation, $8\cos x \cdot \left(\cos\left(\frac{\pi}{6}+x\right) \cdot \cos\left(\frac{\pi}{6}-x\right) - \frac{1}{2}\right) = 1$ in $[0, \pi]$ is

$k\pi$, then k is equal to :

(1) $\frac{8}{9}$

(2) $\frac{20}{9}$

(3) $\frac{2}{3}$

(4) $\frac{13}{9}$

38. (4)

$$8\cos x \left[\cos\left(\frac{\pi}{6}+x\right) \cdot \cos\left(\frac{\pi}{6}-x\right) - \frac{1}{2} \right] = 1$$

$$8\cos x \left[\frac{\cos\left(\frac{\pi}{3}\right) + \cos 2x - 1}{2} \right] = 1$$

$$4\cos x \left(\cos 2x - \frac{1}{2} \right) = 1$$

$$4\cos x \left(2\cos^2 x - \frac{3}{2} \right) = 1$$

$$8\cos^3 x - 6\cos x - 1 = 0$$

$$2(4\cos^3 x - 3\cos x) - 1 = 0$$

$$2\cos 3x - 1 = 0$$

$$\cos 3x = \frac{1}{2} = \cos \frac{\pi}{3}$$

$$3x = 2n\pi \pm \frac{\pi}{3}$$

$$x = \frac{2n\pi}{3} \pm \frac{\pi}{9} = \frac{7\pi}{9}, \frac{5\pi}{9}, \frac{\pi}{9} \text{ in } [0, \pi]$$

$$\therefore k = \frac{13}{9}$$

39. A bag contains 4 red and 6 black balls. A ball is drawn at random from the bag, its colour is observed and this ball along with two additional balls of the same colour are returned to the bag. If now a ball is drawn at random from the bag, then the probability that this drawn ball is red, is :

(1) $\frac{1}{5}$

(2) $\frac{3}{4}$

(3) $\frac{3}{10}$

(4) $\frac{2}{5}$

39. (4)

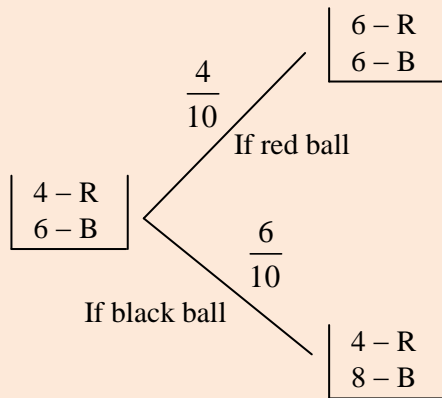

From total Probability Theorem

$$\begin{aligned} P(R) &= \frac{4}{10} \times \frac{1}{2} + \frac{6}{10} \times \frac{4}{12} \\ &= \frac{1}{5} + \frac{1}{5} \\ &= \frac{2}{5} \end{aligned}$$

40. Let $f(x) = x^2 + \frac{1}{x^2}$ and $g(x) = x - \frac{1}{x}$, $x \in \mathbf{R} - \{-1, 0, 1\}$. If $h(x) = \frac{f(x)}{g(x)}$, then the local minimum value of $h(x)$ is :

- (1) $-2\sqrt{2}$ (2) $2\sqrt{2}$ (3) 3 (4) -3

40. (2)

$$\begin{aligned} h(x) = \frac{f(x)}{g(x)} &= \frac{x^2 + \frac{1}{x^2}}{x - \frac{1}{x}} \\ &= \frac{x^4 + 1}{(x^2 - 1)x} \\ &= \frac{x^4 + 1}{x^3 - x} \\ &= \frac{x^4 + 1}{x(x+1)(x-1)} \end{aligned}$$

$$h(x) = \frac{f(x)}{g(x)} = \frac{x^2 + \frac{1}{x^2}}{x - \frac{1}{x}} = \left(x - \frac{1}{x}\right) + \frac{2}{x - \frac{1}{x}}$$

$$\text{When } x - \frac{1}{x} < 0 \Rightarrow \left(x - \frac{1}{x}\right) + \frac{2}{x - \frac{1}{x}} \leq -2\sqrt{2}$$

$$x - \frac{1}{x} > 0 \Rightarrow \left(x - \frac{1}{x}\right) + \frac{2}{x - \frac{1}{x}} \geq 2\sqrt{2}$$

Minimum value $2\sqrt{2}$

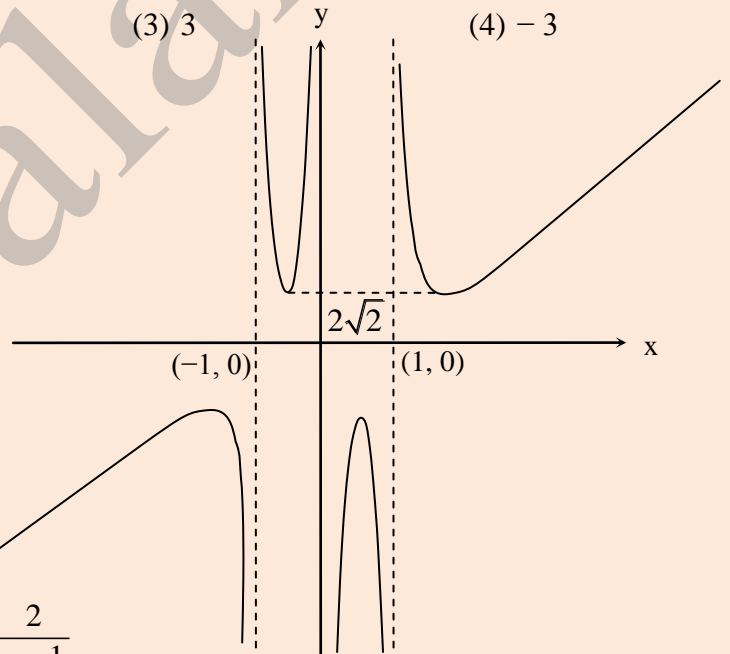

41. Two sets A and B are as under :

$$A = \{(a, b) \in \mathbf{R} \times \mathbf{R} : |a - 5| < 1 \text{ and } |b - 5| < 1\}$$

$$B = \{(a, b) \in \mathbf{R} \times \mathbf{R} : 4(a - 6)^2 + 9(b - 5)^2 \leq 36\}. \text{ Then :}$$

- (1) $A \cap B = \phi$ (an empty set) (2) neither $A \subset B$ nor $B \subset A$
 (3) $B \subset A$ (4) $A \subset B$

41. (4)

$$A = \{(a, b) \in \mathbf{R} \times \mathbf{R} : |a - 5| < 1 \text{ and } |b - 5| < 1\}$$

$$\Rightarrow -1 < a - 5 < 1$$

$$4 < a < 6$$

$$4 < b < 6$$

$$B = \{(a, b) \in \mathbf{R} \times \mathbf{R}$$

$$4(a - 6)^2 + 9(b - 5)^2 \leq 36$$

$$\frac{(a - 6)^2}{9} + \frac{(b - 5)^2}{4} \leq 1$$

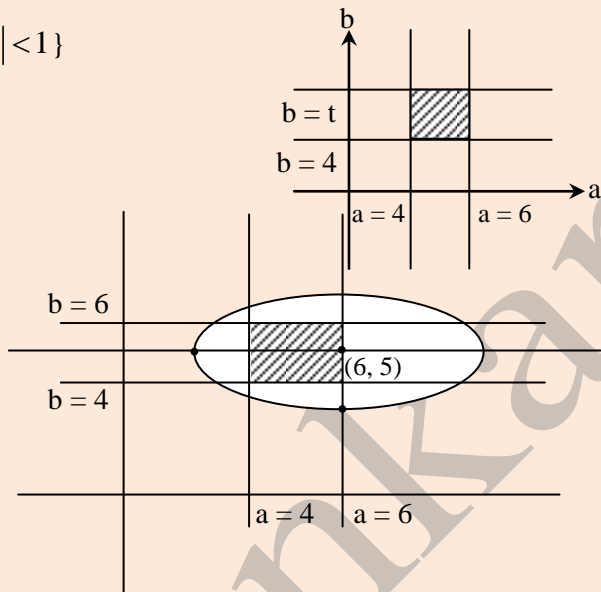

42. The Boolean expression : $\sim(p \vee q) \vee (\sim p \wedge q)$ is equivalent to :

- (1) q (2) $\sim q$ (3) $\sim p$ (4) p

42. (3)

P (1)	q (2)	$\sim P$ (3)	$(p \vee q)$ (4)	$\sim (p \vee q)$ (5)	$\sim p \wedge q$ (6)	$\sim (p \vee q) \vee (\sim p \wedge q)$
T	T	F	T	F	F	F
T	F	F	T	F	F	F
F	T	T	T	F	T	T
F	F	T	F	T	F	T

Entries in column (3) and (7) are identical.

43. Tangent and normal are drawn at P(16, 16) on the parabola $y^2 = 16x$, which intersect the axis of the parabola at A and B, respectively. If C is the centre of the circle through the points P, A and B and $\angle CPB = \theta$, then a value of $\tan \theta$ is :

- (1) 3 (2) $\frac{4}{3}$ (3) $\frac{1}{2}$ (4) 2

43. (4)

Tangent and normal are drawn at P (16, 16) on $y^2 = 16x$

Hence equation of tangent is $x - 2y - 16 = 0$ and equation of normal is $2x + y = 48$

$$\therefore A \equiv (-16, 0) \text{ and } B \equiv (24, 0)$$

$$l(PB) = \sqrt{64 + 256} = 8\sqrt{5}$$

$$\therefore l(PM) = 4\sqrt{5}$$

$$\text{Also } CP^2 = CB^2 = CA^2$$

Let $C \equiv (h, k)$

$$\therefore (h + 16)^2 + k^2 = (h - 24)^2 + k^2 \Rightarrow h = 4$$

$$\text{Also } (h - 16)^2 + (k - 16)^2 = (h + 16)^2 + k^2$$

$$\therefore 144 + (-32k + 256) = 400 \Rightarrow k = 0$$

$$\therefore C \equiv (4, 0)$$

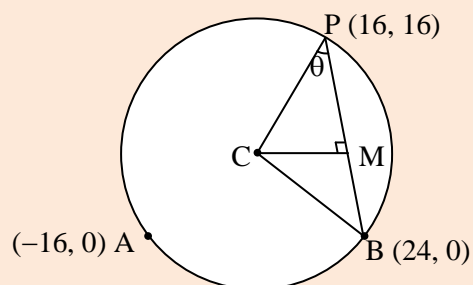

$$\text{Hence CP} = \sqrt{144 + 256} = 20$$

$$\text{In } \Delta \text{ CPM, } \cos \theta = \frac{\text{PM}}{\text{CP}}$$

$$\therefore \cos \theta = \frac{4\sqrt{5}}{20} = \frac{\sqrt{5}}{5} = \frac{1}{\sqrt{5}} \Rightarrow \sin \theta = \frac{2}{\sqrt{5}}$$

$$\therefore \tan \theta = 2$$

44. If $\begin{vmatrix} x-4 & 2x & 2x \\ 2x & x-4 & 2x \\ 2x & 2x & x-4 \end{vmatrix} = (A+Bx)(x-A)^2$, then the ordered pair (A, B) is equal to :

(1) (-4, 5)

(2) (4, 5)

(3) (-4, -5)

(4) (-4, 3)

44. (1)

$$\begin{vmatrix} x-4 & 2x & 2x \\ 2x & x-4 & 2x \\ 2x & 2x & x-4 \end{vmatrix} = (A+Bx)(x-A)^2$$

$$C_1 \rightarrow C_1 + C_2 + C_3$$

$$= \begin{vmatrix} 5x-4 & 2x & 2x \\ 5x-4 & x-4 & 2x \\ 5x-4 & 2x & x-4 \end{vmatrix} = (5x-4) \begin{vmatrix} 1 & 2x & 2x \\ 1 & x-4 & 2x \\ 1 & 2x & x-4 \end{vmatrix}$$

$$R_1 \rightarrow R_1 - R_2$$

$$\begin{aligned} &= (5x-4) \begin{vmatrix} 0 & x+4 & 0 \\ 1 & x-4 & 2x \\ 1 & 2x & x-4 \end{vmatrix} \\ &= (5x-4)(-1)(x+4)(x-4-2x) \\ &= (-1)(5x-4)(x+4)(-x-4) \\ &= (5x-4)(x+4)(x+4) \\ &= (-4+5x)[x-(-4)]^2 \end{aligned}$$

Hence, A = -4, B = 5

45. The sum of the coefficients of all odd degree terms in the expansion of

$$\left(x + \sqrt{x^3 - 1}\right)^5 + \left(x - \sqrt{x^3 - 1}\right)^5, (x > 1) \text{ is :}$$

(1) 1

(2) 2

(3) -1

(4) 0

45. (2)

$$\begin{aligned} &\left(x + \sqrt{x^3 - 1}\right)^5 + \left(x - \sqrt{x^3 - 1}\right)^5 \\ &= \left[x^5 + {}^5C_1 x^4 \sqrt{x^3 - 1} + {}^5C_2 x^3 (x^3 - 1) + {}^5C_3 x^2 (x^3 - 1)^{3/2} + {}^5C_4 x (x^3 - 1)^2 + {}^5C_5 x^0 (x^3 - 1)^{5/2} \right] + \\ &\quad \left[x^5 - {}^5C_1 x^4 \sqrt{x^3 - 1} + {}^5C_2 x^3 (x^3 - 1) - {}^5C_3 x^2 (x^3 - 1)^{3/2} + {}^5C_4 x (x^3 - 1)^2 - {}^5C_5 x^0 (x^3 - 1)^{5/2} \right] \\ &= 2 \left[x^5 + {}^5C_2 x^3 (x^3 - 1) + {}^5C_4 x (x^3 - 1)^2 \right] \end{aligned}$$

Sum of Coefficient of all odd degree

$$\begin{aligned} &= 2 \left[1 - {}^5C_2 + {}^5C_4 + {}^5C_4 \right] \\ &= 2 \end{aligned}$$

46. Let $a_1, a_2, a_3, \dots, a_{49}$ be in A.P. such that, $\sum_{k=0}^{12} a_{4k+1} = 416$ and $a_9 + a_{43} = 66$. If $a_1^2 + a_2^2 + \dots + a_{17}^2 = 140$ m, then m is equal to :
- (1) 34 (2) 33 (3) 66 (4) 68

46. (1)

$a_1, a_2, a_3, \dots, a_{49}$ are in A.P.

Let first term be A and common difference be D.

$$a_9 + a_{43} = 66 \Rightarrow 2A + 50D = 66 \Rightarrow A + 25D = 33$$

$$\therefore a_{26} = 33 \quad \dots \text{ (i)}$$

$$\sum_{k=0}^{12} a_{4k+1} = 416 \Rightarrow a_1 + a_5 + a_9 + \dots + a_{49} = 416$$

$$\therefore 13A + 312D = 416 \Rightarrow A + 24D = 32$$

$$\therefore a_{25} = 32 \quad \dots \text{ (ii)}$$

From (i) and (ii), $a_{26} - a_{25} = D = 1$

$$\text{Also } A + 25D = 33 \Rightarrow A = 8$$

$$\therefore a_1^2 + a_2^2 + a_3^2 + \dots + a_{17}^2$$

$$= 8^2 + 9^2 + 10^2 + \dots + 24^2$$

$$\therefore \sum_{r=1}^{24} r^2 - \sum_{r=1}^7 r^2 = 140 \text{ m}$$

$$\therefore \frac{(24)(25)(49)}{6} - \frac{(7)(8)(15)}{6} = 140 \text{ m}$$

$$\therefore 4900 - 140 = 140 \text{ m} \Rightarrow m = 34$$

47. A straight line through a fixed point (2, 3) intersects the coordinate axes at distinct points P and Q. If O is the origin and the rectangle OPRQ is completed, then the locus of R is :

- (1) $3x + 2y = xy$ (2) $3x + 2y = 6xy$ (3) $3x + 2y = 6$ (4) $2x + 3y = xy$

47. (1)

$$\text{line } y - 3 = m(x - 2)$$

$$y - 3 = mx - 2m$$

$$P \equiv \left(\frac{2m-3}{m}, 0 \right), \quad Q \equiv (0, 3-2m)$$

Let R (α, β)

$$\text{So, } \alpha = \frac{2m-3}{m} \quad \text{and} \quad \beta = 3 - 2m$$

$$\therefore m = \frac{3}{2-\alpha} \quad \text{and} \quad m = \frac{3-\beta}{2}$$

$$\therefore \frac{3}{2-\alpha} = \frac{3-\beta}{2} \Rightarrow 6 = 6 - 2\beta - 3\alpha + \alpha\beta$$

Locus of R (α, β) is $3x + 2y = xy$

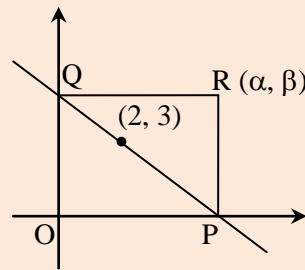

48. The value of $\int_{-\frac{\pi}{2}}^{\frac{\pi}{2}} \frac{\sin^2 x}{1+2^x} dx$ is :

- (1) 4π (2) $\frac{\pi}{4}$ (3) $\frac{\pi}{8}$ (4) $\frac{\pi}{2}$

48. (2)

$$I = \int_{-\pi/2}^{\pi/2} \frac{\sin^2 x}{1+2^x} dx \quad \dots\dots (1)$$
$$= \int_{-\pi/2}^{\pi/2} \frac{\sin^2 x}{1+\frac{1}{2^x}} dx \quad \int_{-a}^a f(x) dx = \int_{-a}^a f(-x) dx$$

$$I = \int_{-\pi/2}^{\pi/2} \frac{\sin^2 x \times 2^x}{1+2^x} dx \quad \dots\dots (2)$$

(1) + (2)

$$2I = \int_{-\pi/2}^{\pi/2} \sin^2 x dx \quad \text{[Even Function]}$$

$$I = \int_0^{\pi/2} \sin^2 x dx$$

$$I = \frac{1}{2} \int_0^{\pi/2} (1 - \cos 2x) dx = \pi/4$$

49. Let $g(x) = \cos x^2$, $f(x) = \sqrt{x}$, and α, β ($\alpha < \beta$) be the roots of the quadratic equation $18x^2 - 9\pi x + \pi^2 = 0$. Then the area (in sq. units) bounded by the curve $y = (g \circ f)(x)$ and the lines $x = \alpha$, $x = \beta$ and $y = 0$, is :

- (1) $\frac{1}{2}(\sqrt{3} - \sqrt{2})$ (2) $\frac{1}{2}(\sqrt{2} - 1)$ (3) $\frac{1}{2}(\sqrt{3} - 1)$ (4) $\frac{1}{2}(\sqrt{3} + 1)$

49. (3)

$$18x^2 - 9\pi x + \pi^2 = 0$$

$$\Rightarrow x = \frac{\pi}{6}, \frac{\pi}{3} \text{ (so, } \alpha = \frac{\pi}{6}, \beta = \frac{\pi}{3} \text{)}$$

$$y = (g \circ f)(x) = g(f(x)) = g(\sqrt{x}) = \cos x$$

$$A = \int_{\pi/6}^{\pi/3} \cos x dx = \sin x \Big|_{\pi/6}^{\pi/3} = \frac{\sqrt{3}}{2} - \frac{1}{2} = \frac{\sqrt{3} - 1}{2}$$

50. For each $t \in \mathbf{R}$, let $[t]$ be the greatest integer less than or equal to t . Then

$$\lim_{x \rightarrow 0^+} x \left(\left[\frac{1}{x} \right] + \left[\frac{2}{x} \right] + \dots + \left[\frac{15}{x} \right] \right)$$

- (1) is equal to 120 (2) does not exist (in \mathbf{R}) (3) is equal to 0 (4) is equal to 15

50. (1)

$$\lim_{x \rightarrow 0^+} x \left(\frac{1}{x} - \left\{ \frac{1}{x} \right\} + \frac{2}{x} - \left\{ \frac{2}{x} \right\} + \dots + \frac{15}{x} - \left\{ \frac{15}{x} \right\} \right)$$
$$= \lim_{x \rightarrow 0^+} \left(1 + 2 + \dots + 15 - x \left(\left\{ \frac{1}{x} \right\} + \left\{ \frac{2}{x} \right\} + \dots + \left\{ \frac{15}{x} \right\} \right) \right)$$
$$= 120 - \lim_{x \rightarrow 0^+} x \underbrace{\left(\left\{ \frac{1}{x} \right\} + \left\{ \frac{2}{x} \right\} + \dots + \left\{ \frac{15}{x} \right\} \right)}_{\text{finite}}$$
$$= 120$$

51. If $\sum_{i=1}^9 (x_i - 5) = 9$ and $\sum_{i=1}^9 (x_i - 5)^2 = 45$, then the standard deviation of the 9 items x_1, x_2, \dots, x_9 is :
 (1) 2 (2) 3 (3) 9 (4) 4

51. (1)

$$\text{Variance} = \frac{1}{n} \sum_{i=1}^n x_i^2 - \left(\frac{1}{n} \sum_{i=1}^n x_i \right)^2 = \frac{1}{9}(45) - \left(\frac{1}{9} \times 9 \right)^2 = 5 - 1 = 4$$

$$\therefore \text{S. D.} = \sqrt{4} = 2$$

52. The integral $\int \frac{\sin^2 x \cos^2 x}{(\sin^5 x + \cos^3 x \sin^2 x + \sin^3 x \cos^2 x + \cos^5 x)^2} dx$ is equal to :

(1) $\frac{1}{1 + \cot^3 x} + C$

(2) $\frac{-1}{1 + \cot^3 x} + C$

(3) $\frac{1}{3(1 + \tan^3 x)} + C$

(4) $\frac{-1}{3(1 + \tan^3 x)} + C$

(where C is a constant of integration)

52. (4)

$$\begin{aligned} & \int \frac{\sin^2 x \cos^2 x}{(\sin^5 x + \cos^3 x \sin^2 x + \sin^3 x \cos^2 x + \cos^5 x)^2} dx \\ &= \int \frac{\tan^2 x \cdot \sec^4 x \cdot \sec^2 x}{(\tan^5 x + \tan^2 x + \tan^3 x + 1)^2} dx \quad \text{divide by } \cos^{10} x \\ &= \int \frac{t^2 (1+t^2)^2}{(t^5 + t^2 + t^3 + 1)^2} dt \quad \tan x = t \\ &= \int \frac{t^2 (1+t^2)^2}{(t^3 + 1)^2 (t^2 + 1)^2} dt \\ &= \int \frac{t^2}{(t^3 + 1)^2} dt \quad t^3 + 1 = y \\ &= \int \frac{1}{y^2} \cdot \frac{dy}{3} = \frac{1}{3} \left(-\frac{1}{y} \right) + c = -\frac{1}{3} \cdot \left(\frac{1}{\tan^3 x + 1} \right) + c \end{aligned}$$

53. Let $S = \{t \in \mathbf{R} : f(x) = |x - \pi| \cdot (e^{|x|} - 1) \sin|x|$ is not differentiable at $t\}$. Then the set S is equal to:

(1) $\{\pi\}$

(2) $\{0, \pi\}$

(3) ϕ (an empty set)

(4) $\{0\}$

53. (3)

$$f(x) = |x - \pi| (e^{|x|} - 1) \sin|x|$$

Obviously differentiable at $x = 0$

Check at $x = \pi$

$$\text{R.H.D.} = \lim_{h \rightarrow 0} \frac{f(\pi+h) - f(\pi)}{h}$$

$$\begin{aligned} &= \lim_{h \rightarrow 0} \frac{|\pi + h - \pi| (e^{|\pi+h|} - 1) \sin |\pi + h| - 0}{h} \\ &= \lim_{h \rightarrow 0} \frac{h \cdot (e^{\pi+h} - 1) \cdot \sin(\pi + h)}{h} = \lim_{h \rightarrow 0} -\sinh \cdot (e^{\pi+h} - 1) = 0 \\ \text{L.H.D.} &= \lim_{h \rightarrow 0} \frac{f(\pi - h) - f(\pi)}{-h} \\ &= \lim_{h \rightarrow 0} \frac{|\pi - h - \pi| (e^{|\pi-h|} - 1) \sin |\pi - h|}{-h} = \lim_{h \rightarrow 0} \frac{h \cdot (e^{\pi-h} - 1) \cdot \sin h}{-h} = 0 \end{aligned}$$

So, differentiable at $x = \pi$

54. Let $y = y(x)$ be the solution of the differential equation $\sin x \frac{dy}{dx} + y \cos x = 4x$, $x \in (0, \pi)$. If

$y\left(\frac{\pi}{2}\right) = 0$, then $y\left(\frac{\pi}{6}\right)$ is equal to :

- (1) $-\frac{8}{9}\pi^2$ (2) $-\frac{4}{9}\pi^2$ (3) $\frac{4}{9\sqrt{3}}\pi^2$ (4) $\frac{-8}{9\sqrt{3}}\pi^2$

54. (1)

$$\frac{dy}{dx} + y \cot x = \frac{4x}{\sin x}$$

$$\text{I.F.} = e^{\int \cot x dx} = e^{\log_e |\sin x|} = \sin x \text{ as } x \in (0, \pi)$$

$$y \cdot \sin x = c + \int 4x \, dx$$

$$y \sin x = c + 2x^2$$

$$\text{As } y\left(\frac{\pi}{2}\right) = 0 \Rightarrow 0 \cdot \sin \frac{\pi}{2} = c + 2\left(\frac{\pi}{2}\right)^2 \Rightarrow c = -\frac{\pi^2}{2}$$

$$\text{So, } y \sin x = 2x^2 - \frac{\pi^2}{2}$$

$$\text{Put } x = \frac{\pi}{6}$$

$$y \cdot \sin \frac{\pi}{6} = 2\left(\frac{\pi}{6}\right)^2 - \frac{\pi^2}{2}$$

$$y\left(\frac{1}{2}\right) = \frac{\pi^2}{18} - \frac{\pi^2}{2} = \frac{\pi^2 - 9\pi^2}{18}$$

$$y = \frac{-8}{9}\pi^2$$

55. Let \vec{u} be a vector coplanar with the vectors $\vec{a} = 2\hat{i} + 3\hat{j} - \hat{k}$ and $\vec{b} = \hat{j} + \hat{k}$. If \vec{u} is perpendicular to

\vec{a} and $\vec{u} \cdot \vec{b} = 24$, then $|\vec{u}|^2$ is equal to :

- (1) 256 (2) 84 (3) 336 (4) 315

55. (3)

$$\vec{u} = u_1\hat{i} + u_2\hat{j} + u_3\hat{k}$$

$$\text{As coplanar } \begin{vmatrix} u_1 & u_2 & u_3 \\ 2 & 3 & -1 \\ 0 & 1 & 1 \end{vmatrix} = 0$$

$$4u_1 - 2u_2 + 2u_3 = 0$$

$$2u_1 - u_2 + u_3 = 0 \quad \dots\dots (1)$$

$$\vec{u} \cdot \vec{a} = 0$$

$$\Rightarrow 2u_1 + 3u_2 - u_3 = 0 \quad \dots\dots (2)$$

$$\vec{u} \cdot \vec{b} = 0$$

$$\Rightarrow u_2 + u_3 = 24 \quad \dots\dots (3)$$

Solving $u_1 = -4, u_2 = 8, u_3 = 16$

$$|\vec{u}|^2 = 336$$

56. The length of the projection of the line segment joining the points (5, -1, 4) and (4, -1, 3) on the plane, $x + y + z = 7$ is :

- (1) $\frac{1}{3}$ (2) $\sqrt{\frac{2}{3}}$ (3) $\frac{2}{\sqrt{3}}$ (4) $\frac{2}{3}$

56. (2)
 drs of AB = (1, 0, 1)
 Let θ be angle between line AB and normal of plane.

$$\text{So, } \cos \theta = \frac{1 \times 1 + 0 \times 1 + 1 \times 1}{\sqrt{2} \sqrt{3}} = \frac{\sqrt{2}}{\sqrt{3}}$$

$$\text{So, projection of line AB} = |\overline{AB}| \sin \theta$$

$$= \sqrt{2} \times \sqrt{1 - \frac{2}{3}} = \sqrt{\frac{2}{3}}$$

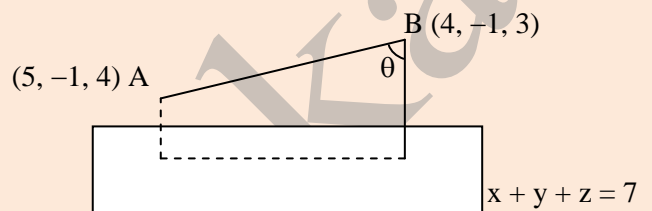

57. PQR is a triangular park with PQ = PR = 200 m. A T.V. tower stands at the mid-point of QR. If the angles of elevation of the top of the tower at P, Q and R are respectively $45^\circ, 30^\circ$ and 30° , then the height of the tower (in m) is :

- (1) $100\sqrt{3}$ (2) $50\sqrt{2}$ (3) 100 (4) 50

57. (3)
 Let TW = tower = h
 $\Delta PTW, \tan 45^\circ = \frac{h}{y_1} \Rightarrow h = y_1$
 Similarly, $\frac{h}{y_2} = \tan 30^\circ \Rightarrow y_2 = \sqrt{3}h$
 $\Delta PQT, PQ^2 = QT^2 + PT^2$
 $40000 = 3h^2 + h^2$
 $h = 100$

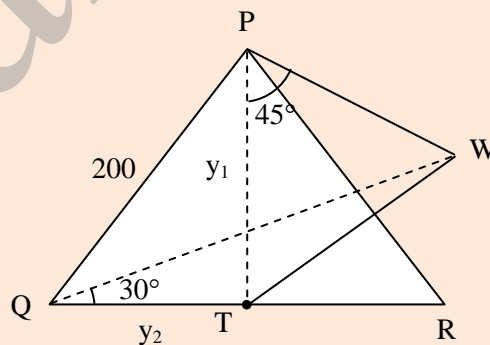

58. From 6 different novels and 3 different dictionaries, 4 novels and 1 dictionary are to be selected and arranged in a row on a shelf so that the dictionary is always in the middle. The number of such arrangements is :

- (1) at least 500 but less than 750 (2) at least 750 but less than 1000
 (3) at least 1000 (4) less than 500

58. (3)
 We have 6 novels and 3 dictionaries. We can select 4 novels and 1 dictionary in ${}^6C_4 \times {}^3C_1 = \frac{6!}{4!2!} \times 3$

$$= \frac{6 \times 5 \times 3}{2} = 45 \text{ ways}$$

Now 4 novels and 1 dictionary are to be arranged so that dictionary is always in middle. So remaining 4 novels can be arranged in $4!$ ways.

Hence total arrangements possible are

$$45 \times 24 = 1080 \text{ ways}$$

(27) VIDYALANKAR : JEE-MAIN 2018 : Question Paper and Solution

59. Let A be the sum of the first 20 terms and B be the sum of the first 40 terms of the series.

$$1^2 + 2.2^2 + 3^2 + 2.4^2 + 5^2 + 2.6^2 + \dots$$

If $B - 2A = 100\lambda$, then λ is equal to :

- (1) 464 (2) 496 (3) 232 (4) 248

59. (4)

$$B = (1^2 + 3^2 + 5^2 + \dots + 39^2) + 2 [2^2 + 4^2 + \dots + 40^2]$$

$$= (1^2 + 2^2 + 3^2 + \dots + 40^2) + [2^2 + 4^2 + \dots + 40^2]$$

$$= (1^2 + 2^2 + \dots + 40^2) + 4 [1^2 + 2^2 + \dots + 20^2]$$

$$A = 1^2 + 2^2 + \dots + 20^2 + 4 [1^2 + 2^2 + \dots + 10^2]$$

$$[\text{Using } 1^2 + 2^2 + \dots + n^2 = \frac{n(n+1)(2n+1)}{6}]$$

$$B - 2A = 24800$$

$$\text{So, } \lambda = 248$$

60. Let the orthocentre and centroid of a triangle be A(-3, 5) and B(3, 3) respectively. If C is the circumcentre of this triangle, then the radius of the circle having line segment AC as diameter, is:

- (1) $3\sqrt{\frac{5}{2}}$ (2) $\frac{3\sqrt{5}}{2}$ (3) $\sqrt{10}$ (4) $2\sqrt{10}$

60. (1)

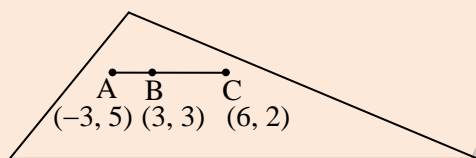

As we know centroid divides line joining circumcentre and orthocentre internally 1 : 2.

So, C (6, 2)

$$AC = \sqrt{(6+3)^2 + (2-5)^2} = \sqrt{90} = 3\sqrt{10}$$

$$r = \frac{AC}{2} = \frac{3\sqrt{10}}{2} = 3\sqrt{\frac{5}{2}}$$

PART- C : CHEMISTRY

61. Total number of lone pair of electron in I_3^- ion is :

- (1) 9 (2) 12 (3) 3 (4) 6

61. (1)

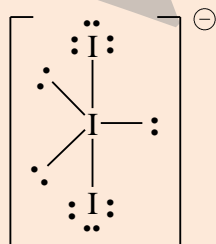

62. Which of the following salts is the most basic in aqueous solution ?

- (1) $FeCl_3$ (2) $Pb(CH_3COO)_2$ (3) $Al(CN)_3$ (4) CH_3COOK

62. (4)

CH_3COOK is most basic among the given options.

63. Phenol reacts with methyl chloroformate in the presence of NaOH to form product A. A reacts with Br₂ to form product B. A and B are respectively :

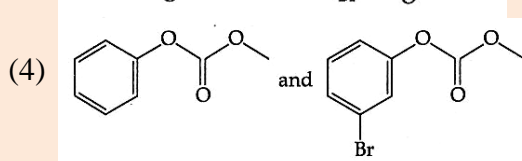
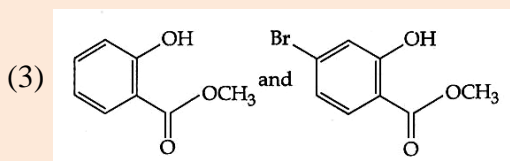
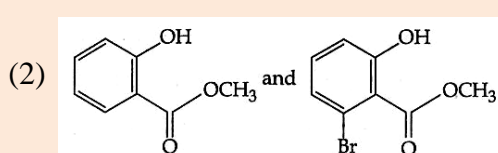
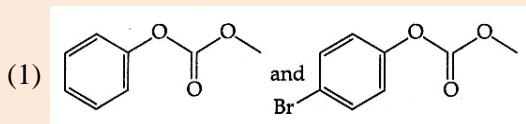

63. (1)

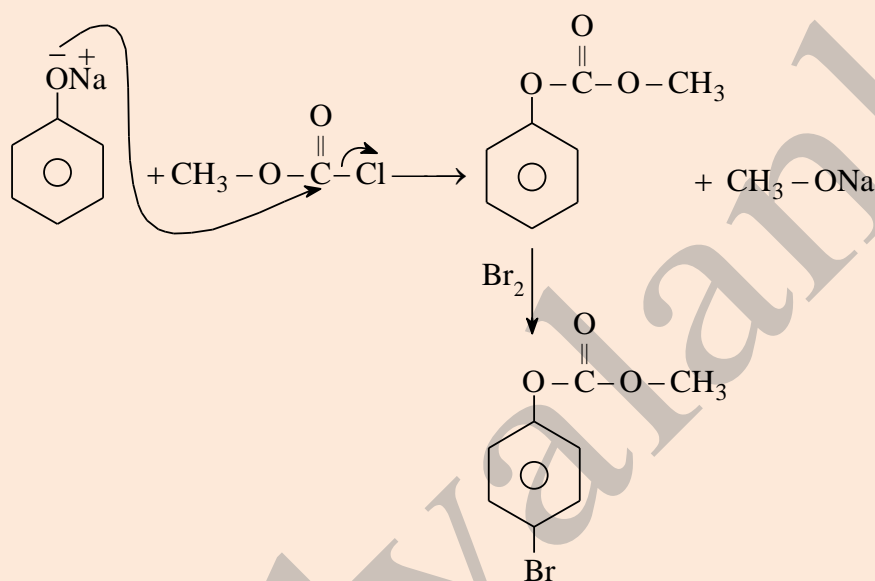
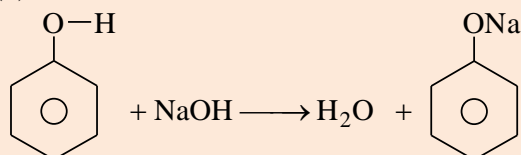

64. The increasing order of basicity of the following compounds is :

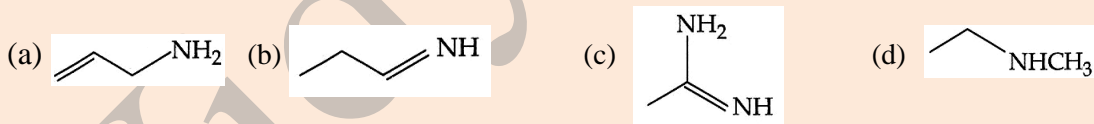

(1) (b) < (a) < (d) < (c)

(2) (d) < (b) < (a) < (c)

(3) (a) < (b) < (c) < (d)

(4) (b) < (a) < (c) < (d)

64. (1)

Basic Nature : (b) < (a) < (d) < (c)

65. An alkali is titrated against an acid with methyl orange as indicator, which of the following is a correct combination ?

	Base	Acid	End Point
(1)	Weak	Strong	Yellow to pinkish red
(2)	Strong	Strong	Pink to colourless
(3)	Weak	Strong	Colourless to pink
(4)	Strong	Strong	Pinkish red to yellow

65. (1)

Fact

(29) VIDYALANKAR : JEE-MAIN 2018 : Question Paper and Solution

66. The trans-alkenes are formed by the reduction of alkynes with :

- (1) Na/liq.NH₃ (2) Sn-HCl
(3) H₂-Pd/C, BaSO₄ (4) NaBH₄

66. (1)

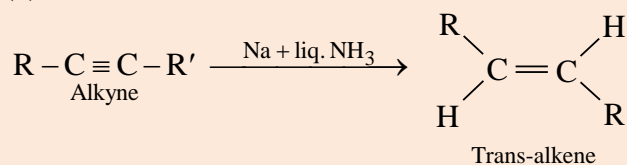

67. The ratio of mass percent of C and H of an organic compound (C_xH_yO_z) is 6 : 1. If one molecule of the above compound (C_xH_yO_z) contains half as much oxygen as required to burn one molecule of compound C_xH_y completely to CO₂ and H₂O. The empirical formula of compound C_xH_yO_z is :

- (1) C₃H₄O₂ (2) C₂H₄O₃ (3) C₃H₆O₃ (4) C₂H₄O

67. (2)



$$\frac{w_C}{w_H} = \frac{12X}{Y} = \frac{6}{1}$$

$$\Rightarrow \frac{X}{Y} = \frac{1}{2}$$

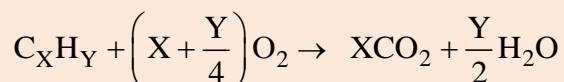

$$X : Y : Z = 2 : 4 : 3$$

68. Hydrogen peroxide oxidises [Fe(CN)₆]⁴⁻ to [Fe(CN)₆]³⁻ in acidic medium but reduces [Fe(CN)₆]³⁻ to [Fe(CN)₆]⁴⁻ in alkaline medium. The other products formed are, respectively :

- (1) H₂O and (H₂O + O₂) (2) H₂O and (H₂O + OH⁻)
(3) (H₂O + O₂) and H₂O (4) (H₂O + O₂) and (H₂O + OH⁻)

68. (1)

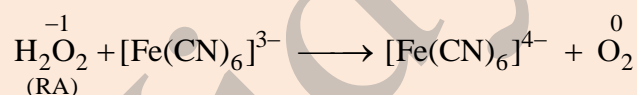
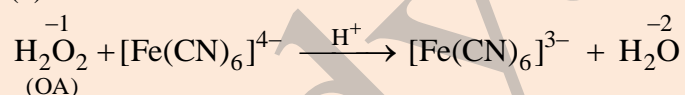

69. The major product formed in the following reaction is :

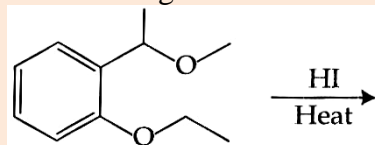

- (1)
(2)
(3)
(4)

69. (2)

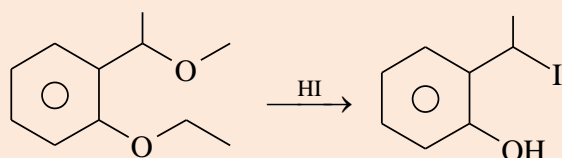

70. How long (approximate) should water be electrolysed by passing through 100 amperes current so that the oxygen released can completely burn 27.66 g of diborane ?

(Atomic weight of B = 10.8 u)

- (1) 3.2 hours (2) 1.6 hours (3) 6.4 hours (4) 0.8 hours

70. (1)



$$\frac{27.6}{27.6} = 1 \text{ mol} \quad 3 \text{ mol}$$

$$\frac{It}{F} = \frac{q}{F} = \frac{w}{E} = n_{\text{O}_2} \times 4$$

$$t = 965 \times 12 \text{ sec} = 3.2 \text{ hr}$$

71. Which of the following lines correctly show the temperature dependence of equilibrium constant K, for an exothermic reaction ?

- (1) C and D
(2) A and D
(3) A and B
(4) B and C

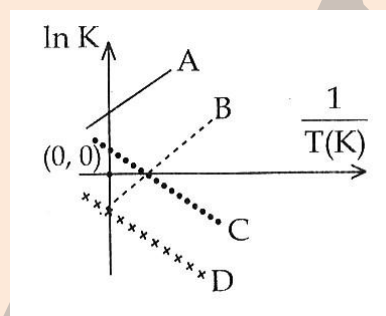

71. (3)

$$\log_{10} K_{\text{eq}} = \text{constant} - \left(\frac{\Delta H}{2.303 R} \right) \left(\frac{1}{T} \right)$$

Given : $\Delta H = -ve$ i.e. slope = + ve

72. At 518°C, the rate of decomposition of a sample of gaseous acetaldehyde, initially at a pressure of 363 Torr, was 1.00 Torr s⁻¹ when 5% had reacted and 0.5 Torr s⁻¹ when 33% had reacted. The order of the reaction is :

- (1) 1 (2) 0 (3) 2 (4) 3

72. (3)

$$\text{Rate of a reaction} = k [\text{P}]^n$$

$$R_1 = 1 \text{ torr / sec} = k \left[365 \times \frac{95}{100} \right]^n$$

$$R_2 = 0.5 \text{ torr / sec} = k \left[365 \times \frac{67}{100} \right]^n$$

$$\frac{1}{0.5} = \left(\frac{95}{67} \right)^n$$

$$2 = \left(\frac{96}{67} \right)^n = (1.43)^n \quad \Rightarrow \quad n = 2$$

73. Glucose on prolonged heating with HI gives :

- (1) Hexanoic acid (2) 6-iodohexanal (3) n-Hexane (4) 1-Hexene

73. (3)

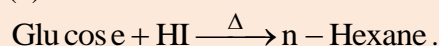

74. Consider the following reaction and statements :

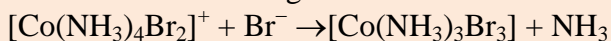

- (I) Two isomers are produced if the reactant complex ion is a cis-isomer.
(II) Two isomers are produced if the reactant complex ion is a trans-isomer.
(III) Only one isomer is produced if the reactant complex ion is a trans-isomer
(IV) Only one isomer is produced if the reactant complex ion is a cis-isomer.

The correct statements are :

- (1) (III) and (IV) (2) (II) and (IV) (3) (I) and (II) (4) (I) and (III)

74. (4)

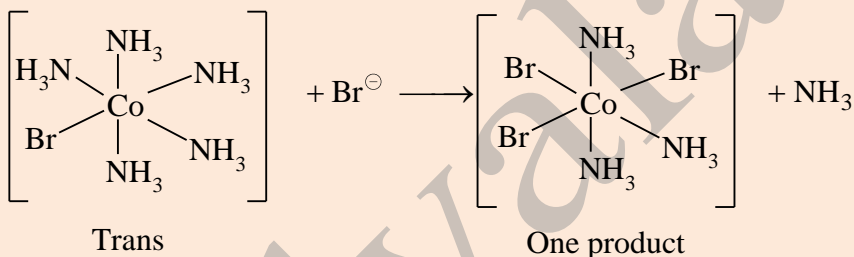
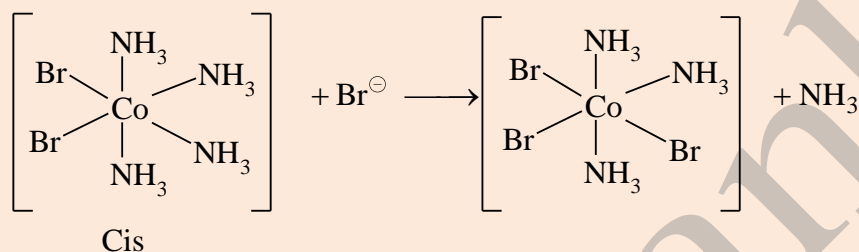
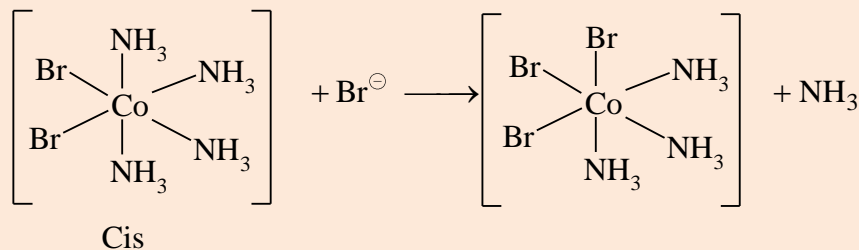

75. The major product of the following reaction is :

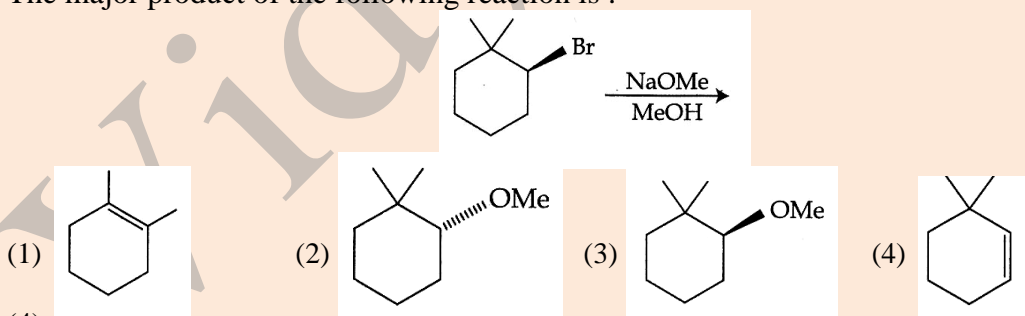

75. (4)

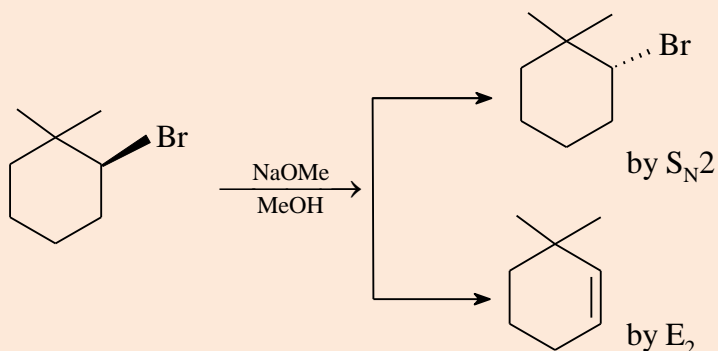

76. Phenol on treatment with CO_2 in the presence of NaOH followed by acidification produces compound X as the major product. X on treatment with $(\text{CH}_3\text{CO})_2\text{O}$ in the presence of catalytic amount of H_2SO_4 produces :

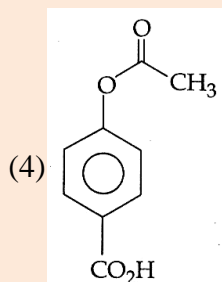
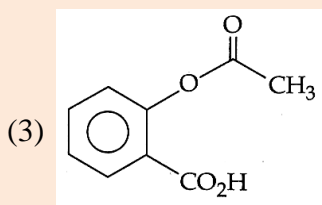
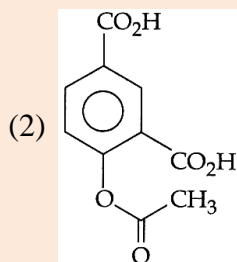
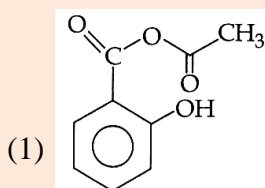

76. (3)

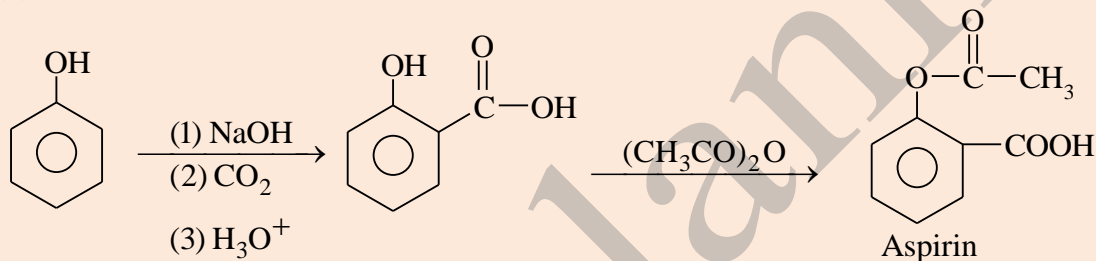

77. An aqueous solution contains an unknown concentration of Ba^{2+} . When 50 mL of a 1M solution of Na_2SO_4 is added, BaSO_4 just begins to precipitate. The final volume is 500 mL. The solubility product of BaSO_4 is 1×10^{-10} . What is the original concentration of Ba^{2+} ?

- (1) 1.1×10^{-9} M (2) 1.0×10^{-10} M (3) 5×10^{-9} M (4) 2×10^{-9} M

77. (1)

$$\left(\frac{MV}{V+50}\right)\left(\frac{1 \times 50}{V+50}\right) = 10^{-10} \quad \dots(1)$$

$V = 450$ mL as total volume = 500 mL

$$\left(\frac{M \times 450}{500}\right)\left(\frac{50}{500}\right) = 10^{-10}$$

$$M = \frac{50}{45} \times 10 \times 10^{-10} = \frac{50}{45} \times 10^{-9} = 1.1 \times 10^{-9} \text{ M}$$

78. Which of the following compounds will be suitable for Kjeldahl's method for nitrogen estimation ?

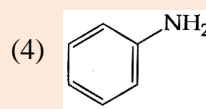
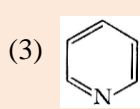
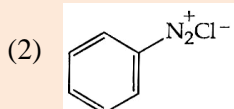
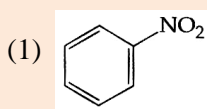

78. (4)

Factual.

79. When metal 'M' is treated with NaOH , a white gelatinous precipitate 'X' is obtained, which is soluble in excess of NaOH . Compound 'X' when heated strongly gives an oxide which is used in chromatography as an adsorbent. The metal 'M' is :

- (1) Al (2) Fe (3) Zn (4) Ca

79. (1)

Alumina is used in chromatography as an adsorbent.

(33) VIDYALANKAR : JEE-MAIN 2018 : Question Paper and Solution

80. An aqueous solution contains 0.10 M H_2S and 0.20 M HCl . If the equilibrium constants for the formation of HS^- from H_2S is 1.0×10^{-7} and that of S^{2-} from HS^- ions is 1.2×10^{-13} then the concentration of S^{2-} ions in aqueous solution is :

- (1) 6×10^{-21} (2) 5×10^{-19} (3) 5×10^{-8} (4) 3×10^{-20}

80 (4)

$$K_1 = 10^{-7}, K_2 = 1.2 \times 10^{-13}$$

$$K_1 K_2 = \frac{[\text{H}^+]^2 [\text{S}^{2-}]}{[\text{H}_2\text{S}]}$$

$$10^{-7} \times 1.2 \times 10^{-13} = \frac{(0.2)^2 (\text{S}^{2-})}{(0.1)}$$

$$[\text{S}^{2-}] = \frac{1.2 \times 10^{-13} \times 10^{-7} \times 0.1}{4 \times 10^{-2}} = \frac{12}{4} \times 10^{-20} = 3 \times 10^{-20}$$

81. The recommended concentration of fluoride ion in drinking water is up to 1 ppm as fluoride ion is required to make teeth enamel harder by converting $[3\text{Ca}_3(\text{PO}_4)_2 \cdot \text{Ca}(\text{OH})_2]$ to :

- (1) $[3\text{Ca}_3(\text{PO}_4)_2 \cdot \text{CaF}_2]$ (2) $[3\{\text{Ca}(\text{OH})_2\} \cdot \text{CaF}_2]$
(3) $[\text{CaF}_2]$ (4) $[3(\text{CaF}_2) \cdot \text{Ca}(\text{OH})_2]$

81. (1)

Factual

82. The compound that **does not** produce nitrogen gas by the thermal decomposition is :

- (1) NH_4NO_2 (2) $(\text{NH}_4)_2\text{SO}_4$ (3) $\text{Ba}(\text{N}_3)_2$ (4) $(\text{NH}_4)_2\text{Cr}_2\text{O}_7$

82. (2)

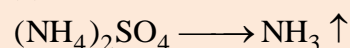

83. The predominant form of histamine present in human blood is (pK_a , Histidine = 6.0)

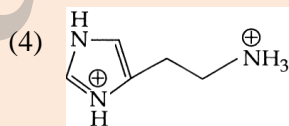
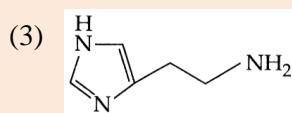
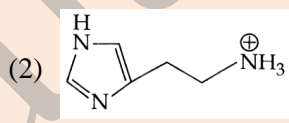
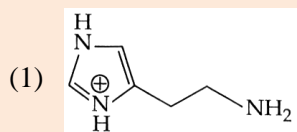

83. (2)

Blood is slightly basic in nature ($\text{pH} 7.35$) at this pH terminal NH_2 will get due to more basic nature.

84. The oxidation states of Cr in $[\text{Cr}(\text{H}_2\text{O})_6]\text{Cl}_3$, $[\text{Cr}(\text{C}_6\text{H}_6)_2]$, and $\text{K}_2[\text{Cr}(\text{CN})_2(\text{O})_2(\text{O}_2)(\text{NH}_3)]$ respectively are :

- (1) +3, 0, and +6 (2) +3, 0, and +4 (3) +3, +4, and +6 (4) +3, +2, and +4

84. (1)

85. Which type of 'defect' has the presence of cations in the interstitial sites ?

- (1) Frenkel defect (2) Metal deficiency defect
(3) Schottky defect (4) Vacancy defect

85. (1)

86. The combustion of benzene (I) gives $\text{CO}_2(\text{g})$ and $\text{H}_2\text{O}(\ell)$. Given that heat of combustion of benzene at constant volume is $-3263.9 \text{ kJ mol}^{-1}$ at 25°C ; heat of combustion (in kJ mol^{-1}) of benzene at constant pressure will be :

$$(\text{R} = 8.314 \text{ JK}^{-1} \text{ mol}^{-1})$$

- (1) 3260 (2) -3267.6 (3) 4152.6 (4) -452.46

86. (2)



$$\Delta n_g = 6 - 7.5 = -1.5$$

$$\begin{aligned}\Delta H &= \Delta U + (\Delta_{ng})RT \\ &= -3263.9 + \frac{(-1.5) \times 8.314 \times 298}{1000} = -3267.6 \text{ kJ/mol}\end{aligned}$$

87. Which of the following are Lewis acids ?

- (1) PH_3 and SiCl_4 (2) BCl_3 and AlCl_3 (3) PH_3 and BCl_3 (4) AlCl_3 and SiCl_4

87. (2)

Factual.

88. Which of the following compounds contain(s) no covalent bond(s) ?

KCl , PH_3 , O_2 , B_2H_6 , H_2SO_4

- (1) KCl (2) KCl , B_2H_6 (3) KCl , B_2H_6 , PH_3 (4) KCl , H_2SO_4

88. (1)

KCl contains Ionic bond.

89. For 1 molal aqueous solution of the following compounds, which one will show the highest freezing point?

(1) $[\text{Co}(\text{H}_2\text{O})_4\text{Cl}_2]\text{Cl} \cdot 2\text{H}_2\text{O}$

(2) $[\text{Co}(\text{H}_2\text{O})_3\text{Cl}_3] \cdot 3\text{H}_2\text{O}$

(3) $[\text{Co}(\text{H}_2\text{O})_6]\text{Cl}_3$

(4) $[\text{Co}(\text{H}_2\text{O})_5\text{Cl}]\text{Cl}_2 \cdot \text{H}_2\text{O}$

89. (2)

90. According to molecular orbital theory, which of the following will **not** be a viable molecule ?

(1) H_2^-

(2) H_2^{2-}

(3) He_2^{2+}

(4) He_2^+

90. (2)

Bond order of $\text{H}_2^{2-} = 0$

