

**MARKING SCHEME
SET 55/1(Compartment)**

Q. No.	Expected Answer / Value Points	Marks	Total Marks															
Section A																		
Set1,Q1 Set2,Q5 Set3,Q4	If it were not so, the presence of a component of the field along the surface would violate its equipotential nature. [Accept any other correct explanation]	1	1															
Set1,Q2 Set2,Q1 Set3,Q5	It would decrease. [NOTE: Also accept if the student just writes 'yes']	1	1															
Set1,Q3 Set2,Q2 Set3,Q1	<div style="display: flex; align-items: center; justify-content: center;">  <table border="1" style="border-collapse: collapse; text-align: center;"> <thead> <tr> <th>A</th> <th>B</th> <th>Y</th> </tr> </thead> <tbody> <tr> <td>0</td> <td>0</td> <td>1</td> </tr> <tr> <td>0</td> <td>1</td> <td>1</td> </tr> <tr> <td>1</td> <td>0</td> <td>1</td> </tr> <tr> <td>1</td> <td>1</td> <td>0</td> </tr> </tbody> </table> </div>	A	B	Y	0	0	1	0	1	1	1	0	1	1	1	0	1/2 + 1/2	1
A	B	Y																
0	0	1																
0	1	1																
1	0	1																
1	1	0																
Set1,Q4 Set2,Q3 Set3,Q2		1	1															
Set1,Q5 Set2,Q4 Set3,Q3	In amplitude modulation, the amplitude, of the carrier wave, changes in accordance with the modulating signal, while in frequency modulation, frequency of the carrier wave varies in accordance with the modulating signal. [NOTE: Also accept if the student draws graphs for the two types of modulation]	1	1															
Section B																		
Set1,Q6 Set2,Q10 Set3,Q9	<table border="1" style="width: 100%; border-collapse: collapse; margin-bottom: 10px;"> <tbody> <tr> <td style="padding: 5px;">Definition of electric flux</td> <td style="text-align: right; padding: 5px;">1/2</td> </tr> <tr> <td style="padding: 5px;">S.I. unit</td> <td style="text-align: right; padding: 5px;">1/2</td> </tr> <tr> <td style="padding: 5px;">Calculation of flux</td> <td style="text-align: right; padding: 5px;">1</td> </tr> </tbody> </table> <p>The 'electric flux', through an elemental area $d\vec{s}$, equals the dot product of $d\vec{s}$, with the electric field, \vec{E}. [Alternatively: Electric flux is the number of electric field lines passing through a given area.] [Also accept, $d\phi = \vec{E} \cdot d\vec{s}$ Or $\phi = \oint_s \vec{E} \cdot d\vec{s}$]</p> <p>S.I. units: $\left(\frac{N \cdot m^2}{C}\right)$ or (V-m)</p> <p>$\phi = \vec{E} \cdot \vec{S} = ES(as \theta = 0^\circ)$</p>	Definition of electric flux	1/2	S.I. unit	1/2	Calculation of flux	1	1/2	1									
Definition of electric flux	1/2																	
S.I. unit	1/2																	
Calculation of flux	1																	

	$= 3 \times 10^3 \times (10 \times 10^{-2})^2 \frac{\text{N}\cdot\text{m}^2}{\text{C}}$ $= 30 \frac{\text{N}\cdot\text{m}^2}{\text{C}}$	1/2	2
Set1,Q7 Set2,Q6 Set3,Q10	<div style="border: 1px solid black; padding: 5px;"> Calculation of Equivalent Resistance of the network 1 1/2 Calculation of current 1/2 </div> <p>The given network has the form given below:</p>  <p>It is a balanced wheatstone Bridge. Its equivalent resistance, R, is given by</p> $\frac{1}{R} = \frac{1}{1+2} + \frac{1}{2+4} = \frac{1}{2}$ $R = 2\Omega$ <p>\therefore Current drawn = $\frac{4V}{2\Omega} = 2A$</p>	1/2 1/2 1/2	2
Set1,Q8 Set2,Q7 Set3,Q6	<div style="border: 1px solid black; padding: 5px;"> Formula 1/2 Calculation of net force on the loop 1 Direction of the net force 1/2 </div>  <p>Here $I_1=2A ; I_2=1A$ $d_1=10 \text{ cm} ; d_2=30 \text{ cm}$ $\mu_0=4\pi \times 10^{-7} \text{ Tm A}^{-1}$ We have $F = \frac{\mu_0 I_1 I_2 l}{2\pi d}$ \therefore Net force on sides ab and cd $= \frac{\mu_0 2 \times 1}{2\pi} \times 20 \times 10^{-2} \left[\frac{1}{10 \times 10^{-2}} - \frac{1}{30 \times 10^{-2}} \right] \text{N}$ $= 4 \times 10^{-7} \times 20 \left[\frac{20}{10 \times 30} \right] \text{N}$ $= \frac{16}{3} \times 10^{-7} \text{N} = 5.33 \times 10^{-7} \text{N}$ This net force is directed towards the infinitely long straight wire.</p>	1/2 1/2	

	<p>Net force on sides bc and da = zero. \therefore Net force on the loop = 5.33×10^{-7} N The force is directed towards the infinitely long straight wire.</p> <p style="text-align: center;">OR</p> <table border="1" style="width: 100%;"> <tr> <td>Formula</td> <td style="text-align: right;">1/2</td> </tr> <tr> <td>Calculation of angle between $\vec{\mu}_m$ and \vec{B}</td> <td style="text-align: right;">1/2</td> </tr> <tr> <td>Calculation of $\vec{\mu}_m$ and torque</td> <td style="text-align: right;">1/2 + 1/2</td> </tr> </table> <p>Torque = $\vec{\mu}_m \times \vec{B}$ $\vec{\mu}_m = nI \times A = 200 \times 5 \times 100 \times 10^{-4} \text{ A-m}^2$ $= 10 \text{ A-m}^2$</p> <p>Angle between $\vec{\mu}_m$ and $\vec{B} = 90^\circ - 60^\circ = 30^\circ$ $\therefore \text{Torque} = 10 \times 0.2 \times \sin 30^\circ$ $= 1 \text{ N-m}$</p>	Formula	1/2	Calculation of angle between $\vec{\mu}_m$ and \vec{B}	1/2	Calculation of $ \vec{\mu}_m $ and torque	1/2 + 1/2	1/2 1/2 1/2 1/2 1/2 1/2	2 2
Formula	1/2								
Calculation of angle between $\vec{\mu}_m$ and \vec{B}	1/2								
Calculation of $ \vec{\mu}_m $ and torque	1/2 + 1/2								
Set1,Q9 Set2,Q10 Set3,Q7	<table border="1" style="width: 100%;"> <tr> <td>Naming of the three waves</td> <td style="text-align: right;">1/2 + 1/2 + 1/2</td> </tr> <tr> <td>Method of production (any one)</td> <td style="text-align: right;">1/2</td> </tr> </table> <p>i. γ rays (or X-rays) ii. Ultraviolet rays iii. Infrared rays</p> <p>Production γ rays : (radioactive decay of nuclei) X-rays : (x-ray tubes or inner shell electrons) UV- rays: (Movement from one inner energy level to another) Infrared rays: (vibration of atoms and molecules) (Any one)</p>	Naming of the three waves	1/2 + 1/2 + 1/2	Method of production (any one)	1/2	1/2 1/2 1/2 1/2	 2		
Naming of the three waves	1/2 + 1/2 + 1/2								
Method of production (any one)	1/2								
Set1,Q10 Set2,Q9 Set3,Q8	<table border="1" style="width: 100%;"> <tr> <td>(a) Finding the transition</td> <td style="text-align: right;">1</td> </tr> <tr> <td>(b) Radiation of maximum wavelength</td> <td style="text-align: right;">1/2</td> </tr> <tr> <td>Justification</td> <td style="text-align: right;">1/2</td> </tr> </table> <p>(a) For hydrogen atom, $E_1 = -13.6 \text{ eV}$; $E_2 = -3.4 \text{ eV}$; $E_3 = -1.51 \text{ eV}$; $E_4 = -0.85 \text{ eV}$ $h = 6.63 \times 10^{-34} \text{ Js}$; $c = 3 \times 10^8 \text{ ms}^{-1}$ Photon Energy = $\frac{hc}{\lambda}$ $= \frac{6.63 \times 10^{-34} \times 3 \times 10^8}{496 \times 10^{-9} \times 1.6 \times 10^{-19}} \text{ eV}$ $\cong 2.5 \text{ eV}$ This equals (nearly) the difference ($E_4 - E_2$). Hence the required transition is (n=4) to (n=2) [Alternatively : If the candidate calculates by using Rydberg formula, and identifies correctly the required transition, full credit may be given.] (b) The transition n=4 to n=3 corresponds to emission of radiation of maximum wavelength. It is so because this transmission gives out the photon of least energy.</p>	(a) Finding the transition	1	(b) Radiation of maximum wavelength	1/2	Justification	1/2	 1/2 1/2 1/2 1/2	 2
(a) Finding the transition	1								
(b) Radiation of maximum wavelength	1/2								
Justification	1/2								

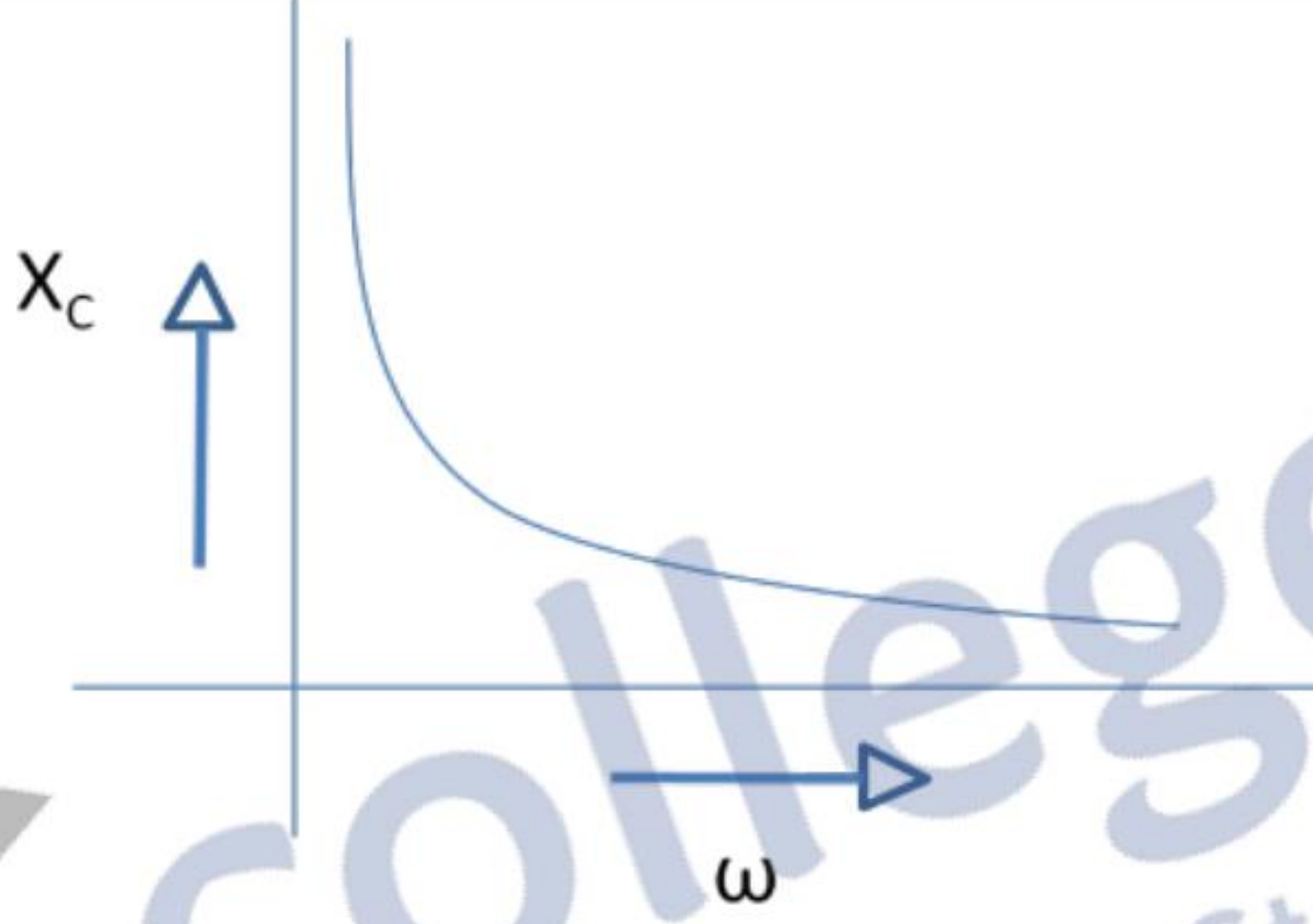
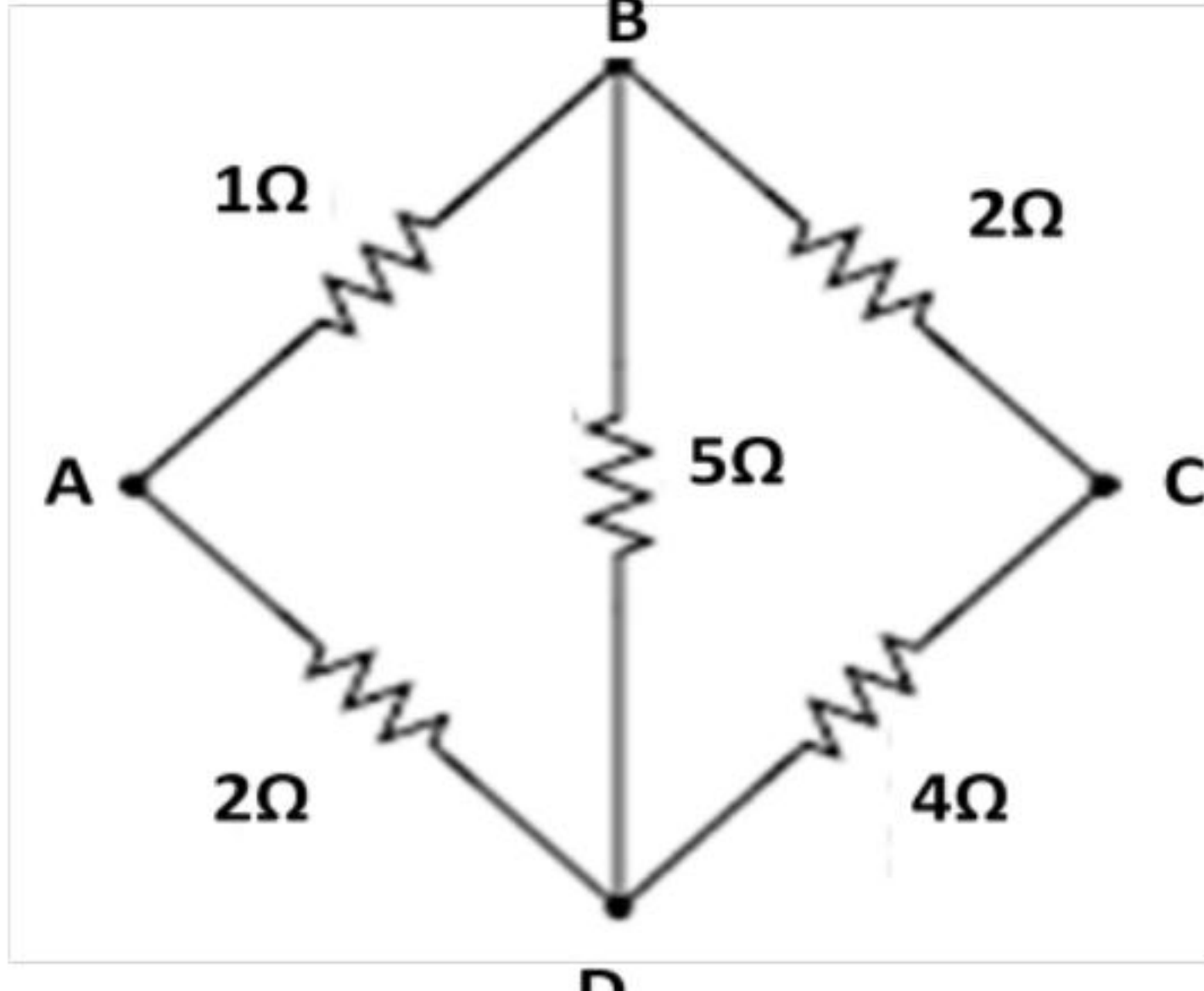
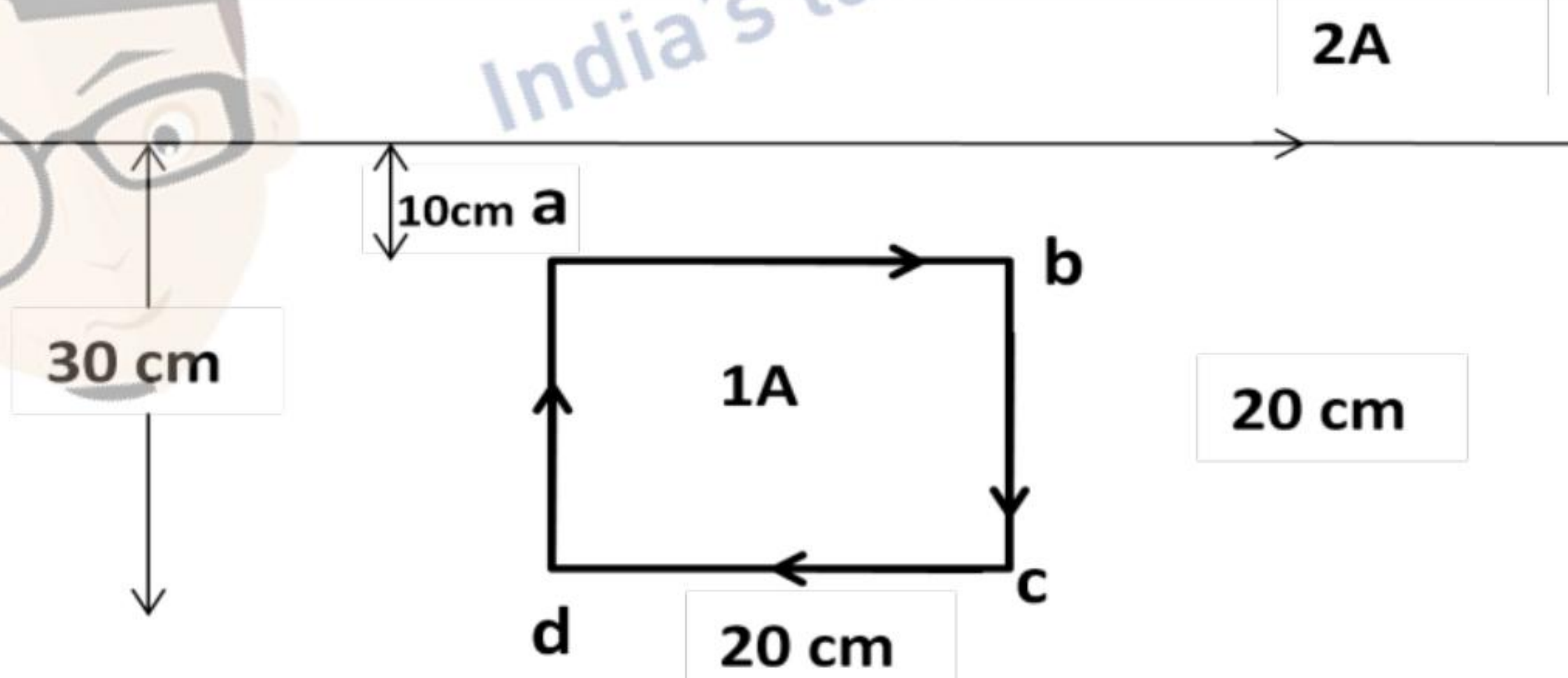

Section C

Set1,Q11
Set2,Q19
Set3,Q16

(a) Derivation of the relation between I and $ \vec{v}_d $	2
(b) Calculation of the charge flowing in 10 s	1

(a) According to the figure,
 $\Delta x = v_d st$
Hence, amount of charge crossing area A in time Δt

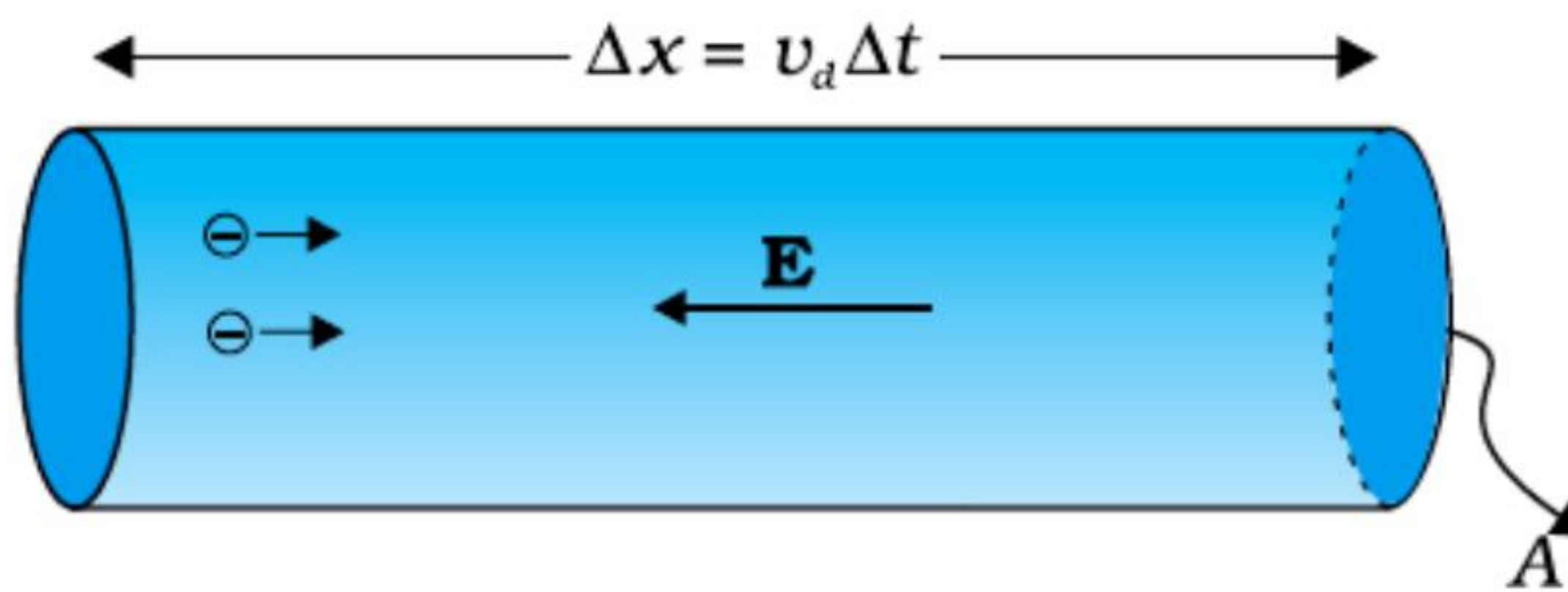

$\therefore \Delta Q = I \Delta t = neA|v_d| \Delta t$
 $\therefore I = neAv_d$

(b) Charge flowing = $\sum I \Delta t$
= area under the curve
 $= \left[\frac{1}{2} \times 5 \times 5 + 5(10 - 5) \right] C$
 $= 37.5 C$

1/2

1/2

1/2

1/2

1/2

1/2

3

Set1,Q12
Set2,Q20
Set3,Q17

Circuit Diagram	1
Working Principle	1/2
Derivation of necessary formula	1 1/2

The circuit diagram, of the potentiometer, is as shown here:

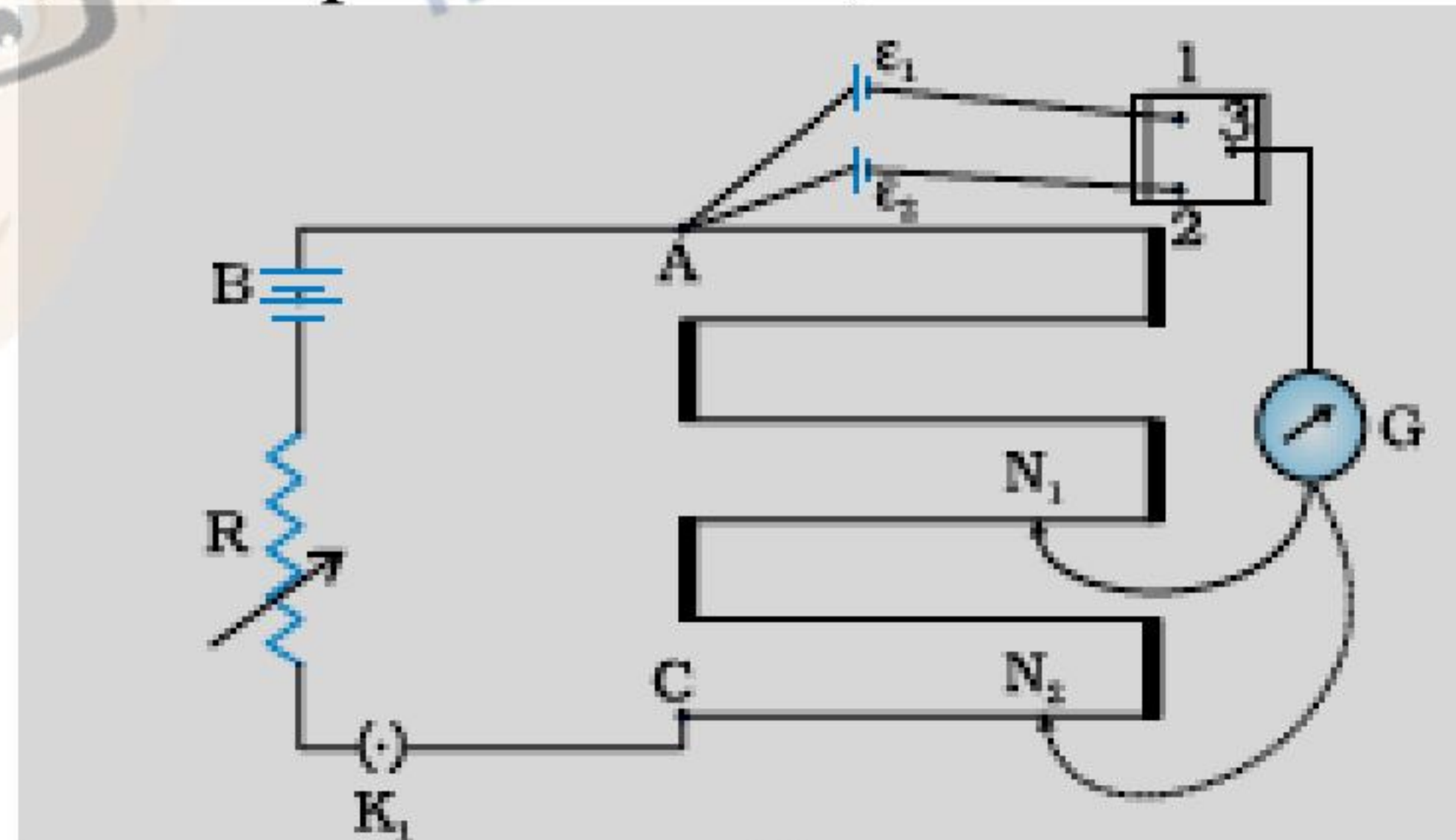

Working Principle:

The potential drop, V , across a length l of a uniform wire, is proportional to the length l of the wire.

(or $V \propto l$ (for a uniform wire))

Derivation:

Let the points 1 and 3 be connected together. Let the balance point be at the point N_1 where $AN_1 = l_1$

Next let the points 2 and 3 be connected together. Let the balance point be at the point N_2 where $AN_2 = l_2$.

We then have

$\varepsilon_1 = kl_1$

and $\varepsilon_2 = kl_2$

1

1/2

1/2

1/2



$$\therefore \frac{\epsilon_1}{\epsilon_2} = \frac{l_1}{l_2}$$

OR

Circuit Diagram	1/2
Working Principle	1
Determination of unknown resistance	1
Precautions	1/2

The circuit diagram of the meter bridge is as shown below:

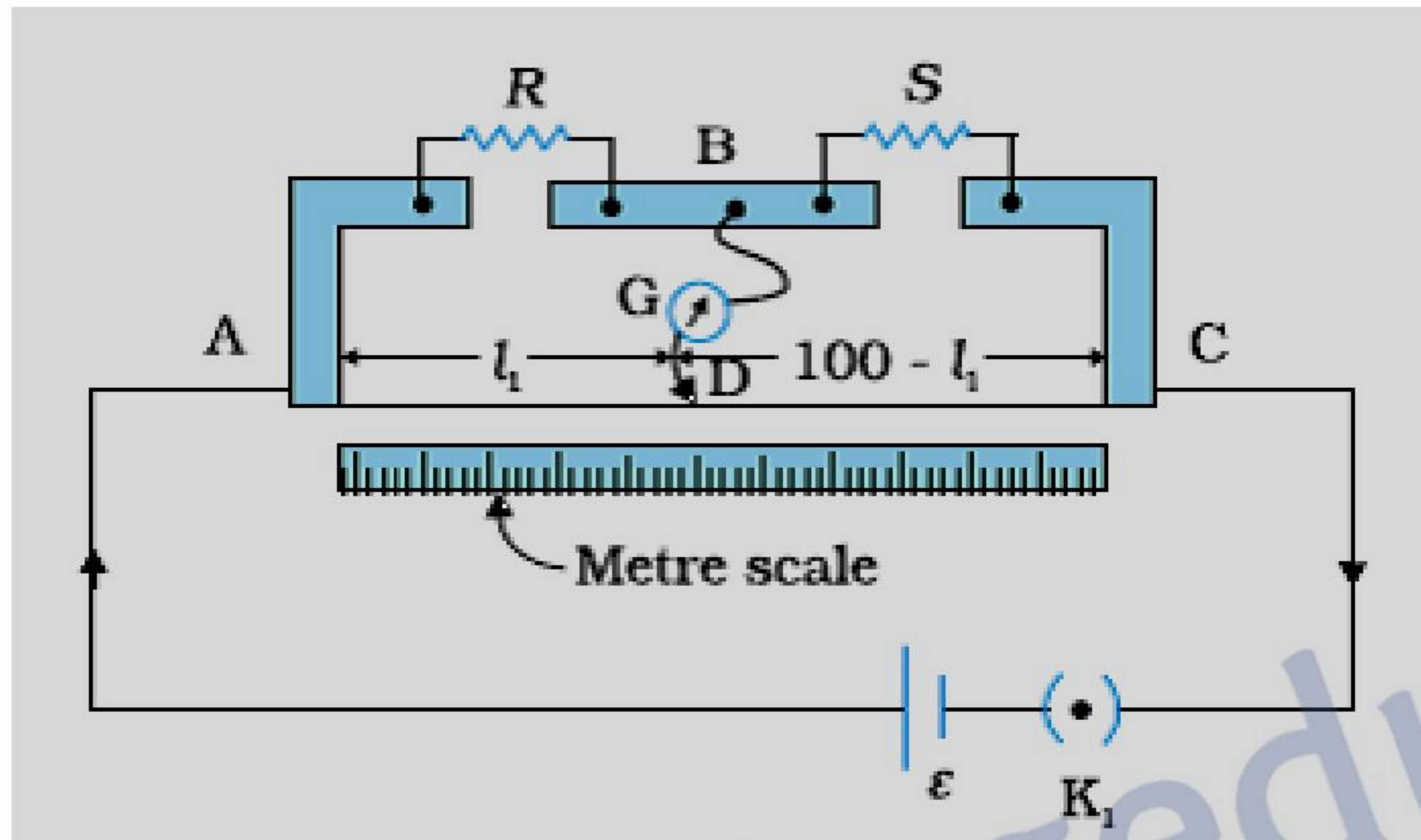

Working Principle: The working principle of the meter bridge is the same as that of a wheatstone bridge. The Wheatstone bridge gets balanced when:

$$\frac{R_2}{R_1} = \frac{R_4}{R_3}$$

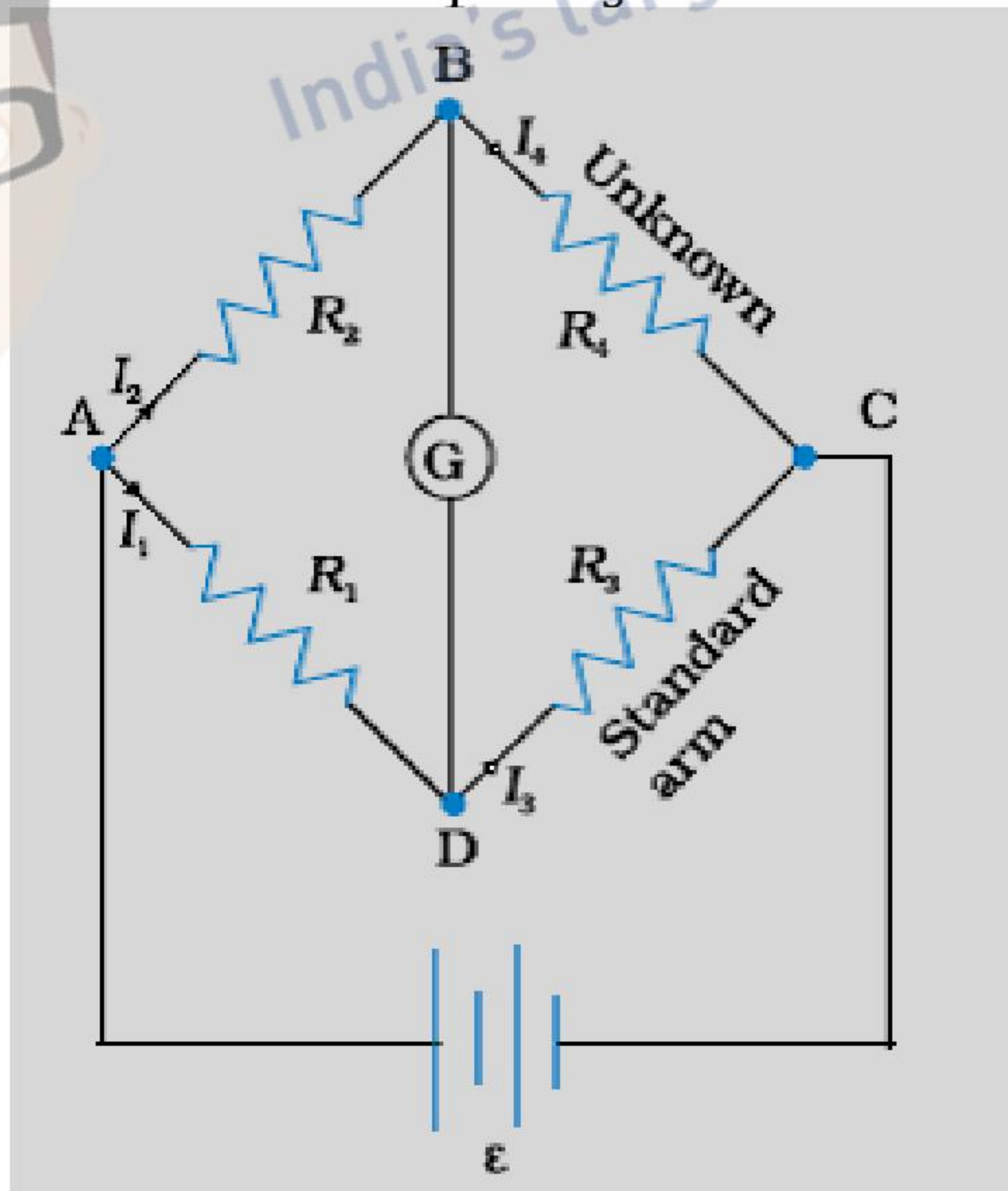

For the meter bridge, circuit shown above, this relation takes the form

$$\frac{R}{S} = \frac{l_1}{(100 - l_1)}$$

Determination of unknown Resistance (R):

In the circuit diagram shown above, S is taken as a known standard resistance. We find the value of the balancing length l_1 , corresponding to a given value of S. We then use the relation:

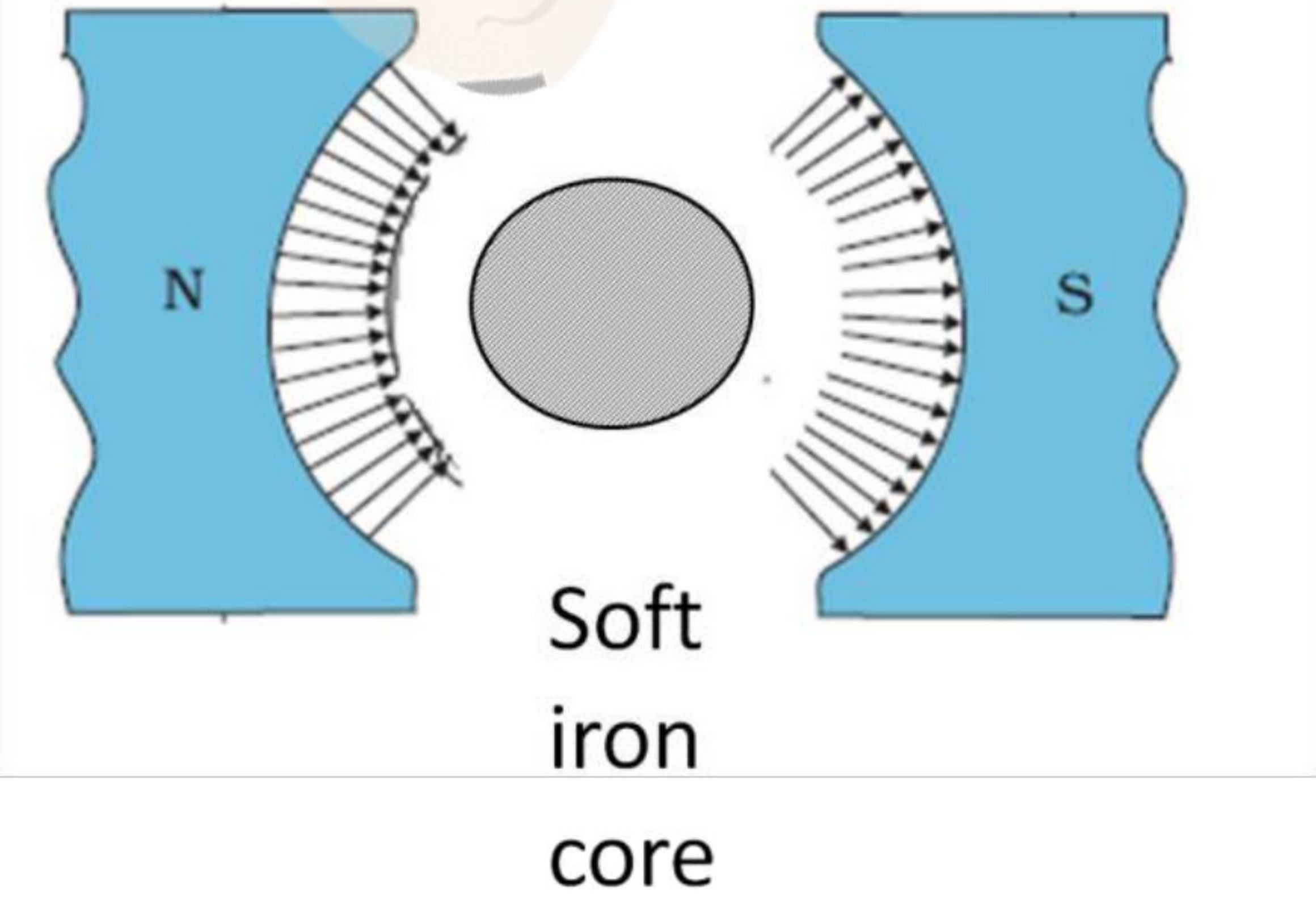
	$\frac{R}{S} = \frac{l_1}{(100 - l_1)}$ <p>to calculate R. By choosing (at least three) different value of S, we calculate R each time. The average of these values of R gives the value of the unknown resistance.</p> <p>Precautions: (1) Make all contacts in a neat, clean and tight manner (2) Select those values of S for which the balancing length is close to the middle point of the wire.[Any one]</p>	1/2									
Set1,Q13 Set2,Q21 Set3,Q18	<table border="1" data-bbox="324 801 1574 1028"> <tr> <td>(a) Need for having a radial Magnetic field</td> <td>1</td> </tr> <tr> <td>Achieving the radial field</td> <td>1/2</td> </tr> <tr> <td>(b) Formula</td> <td>1/2</td> </tr> <tr> <td>Calculation of the required resistance</td> <td>1</td> </tr> </table> <p>(a) Need for a radial magnetic field: The relation between the current (i) flowing through the galvanometer coil, and the angular deflection (ϕ) of the coil (from its equilibrium position), is</p> $\phi = \left(\frac{NABl \sin \theta}{k} \right)$ <p>where θ is the angle between the magnetic field \vec{B} and the equivalent magnetic moment $\vec{\mu}_m$ of the current carrying coil. Thus I is not directly proportional to ϕ. We can ensure this proportionality by having $\theta = 90^\circ$. This is possible only when the magnetic field, \vec{B}, is a radial magnetic field. In such a field, the plane of the rotating coil is always parallel to \vec{B}. To get a radial magnetic field, the pole pieces of the magnet, are made concave in shape. Also a soft iron cylinder is used as the core. [Alternatively : Accept if the candidate draws the following diagram to achieve the radial magnetic field.]</p>  <p>(b) We have $R = \left[\frac{V}{I_m} - G \right]$</p> $\therefore I_m = \frac{V}{R + G}$ <p>We must also have</p> $I_m = \frac{\left(\frac{V}{2} \right)}{R' + G}$	(a) Need for having a radial Magnetic field	1	Achieving the radial field	1/2	(b) Formula	1/2	Calculation of the required resistance	1	1/2 1/2 1/2 1/2	3
(a) Need for having a radial Magnetic field	1										
Achieving the radial field	1/2										
(b) Formula	1/2										
Calculation of the required resistance	1										

	<p>where $R' =$ Resistance required to change the range from) 0 to $V/2$</p> $\therefore 1 = \frac{2(R' + G)}{R + G}$ $\therefore R' = \frac{R - G}{2}$	$\frac{1}{2}$	3
--	--	---------------	---

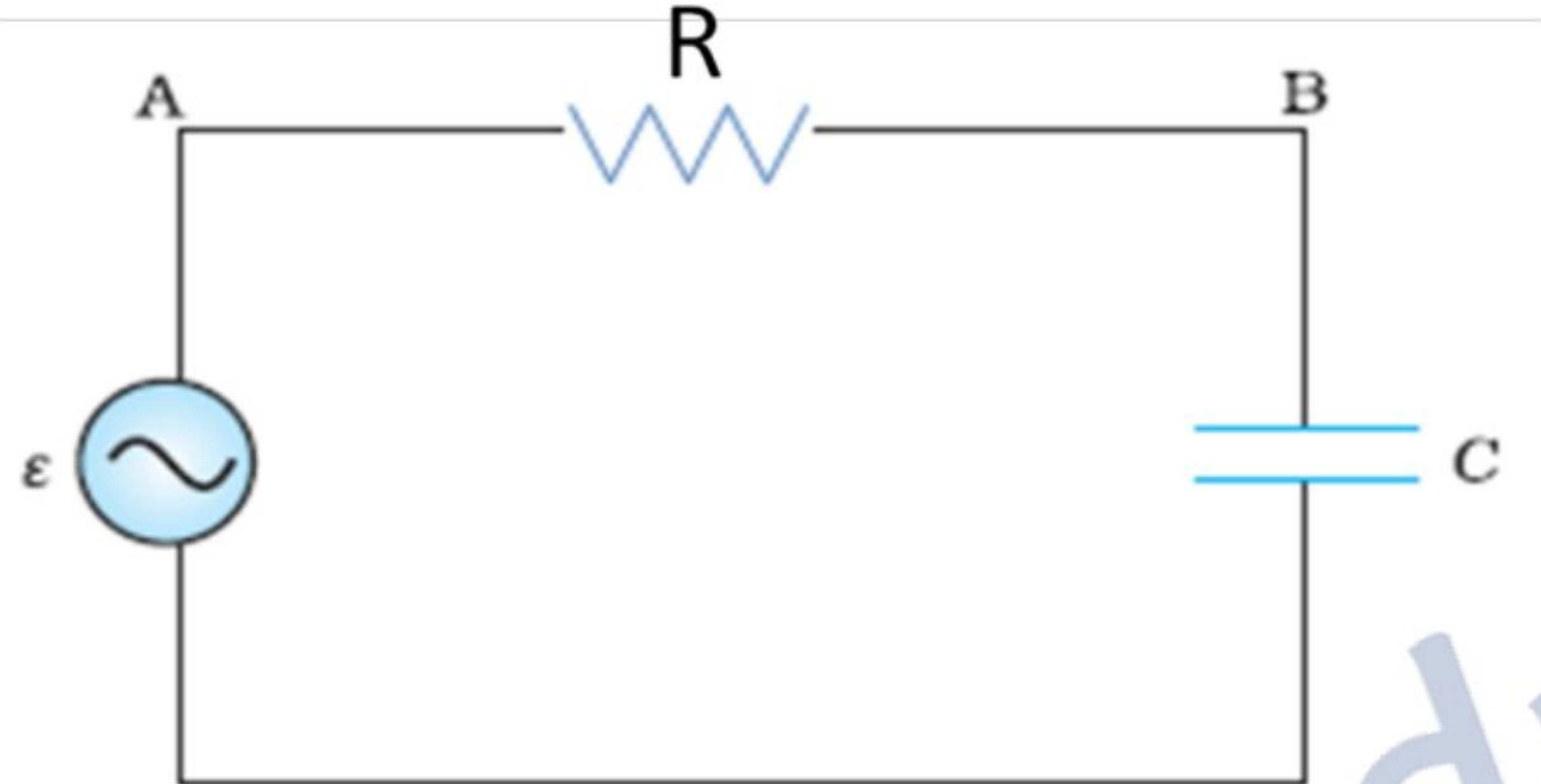
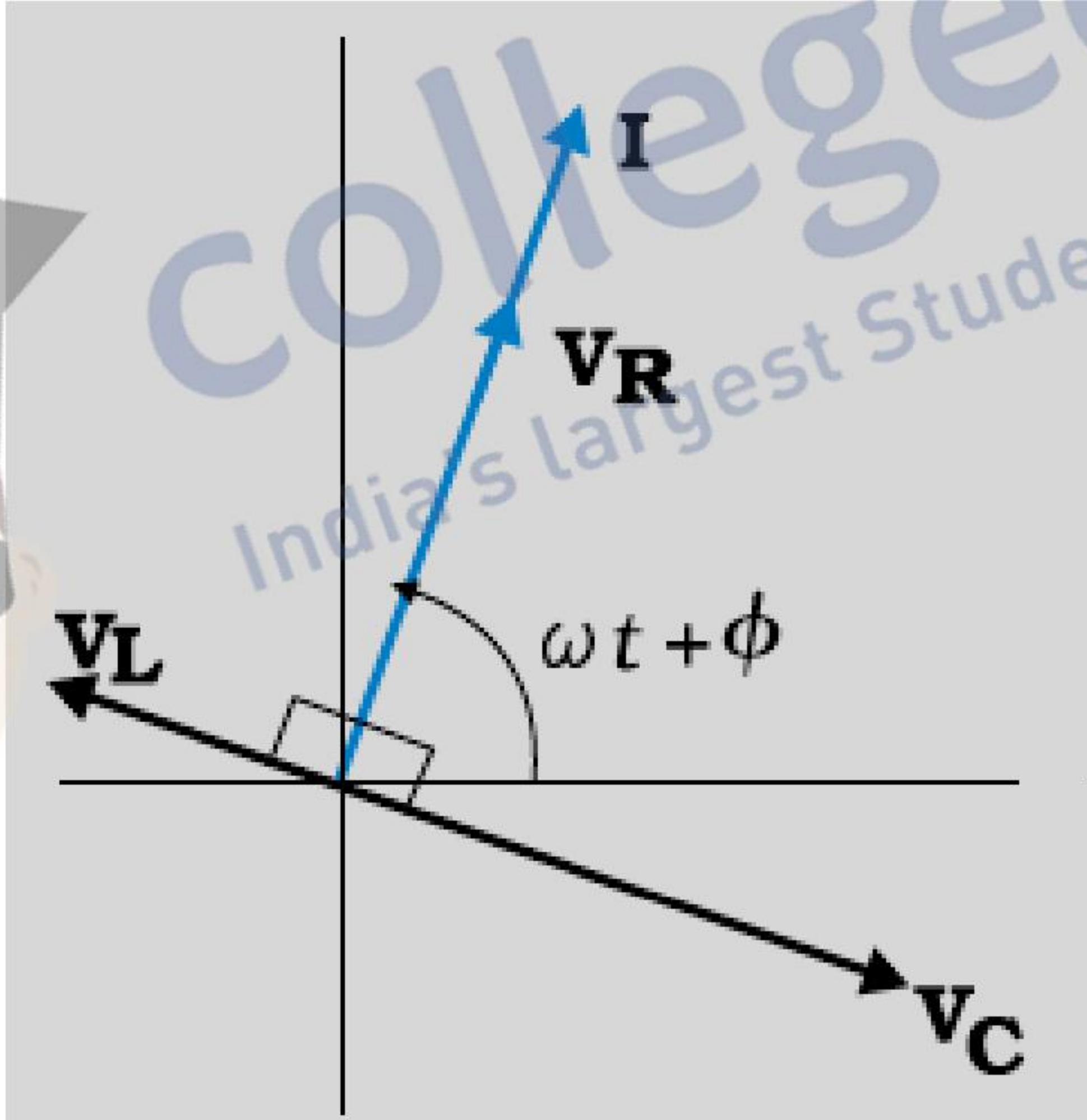
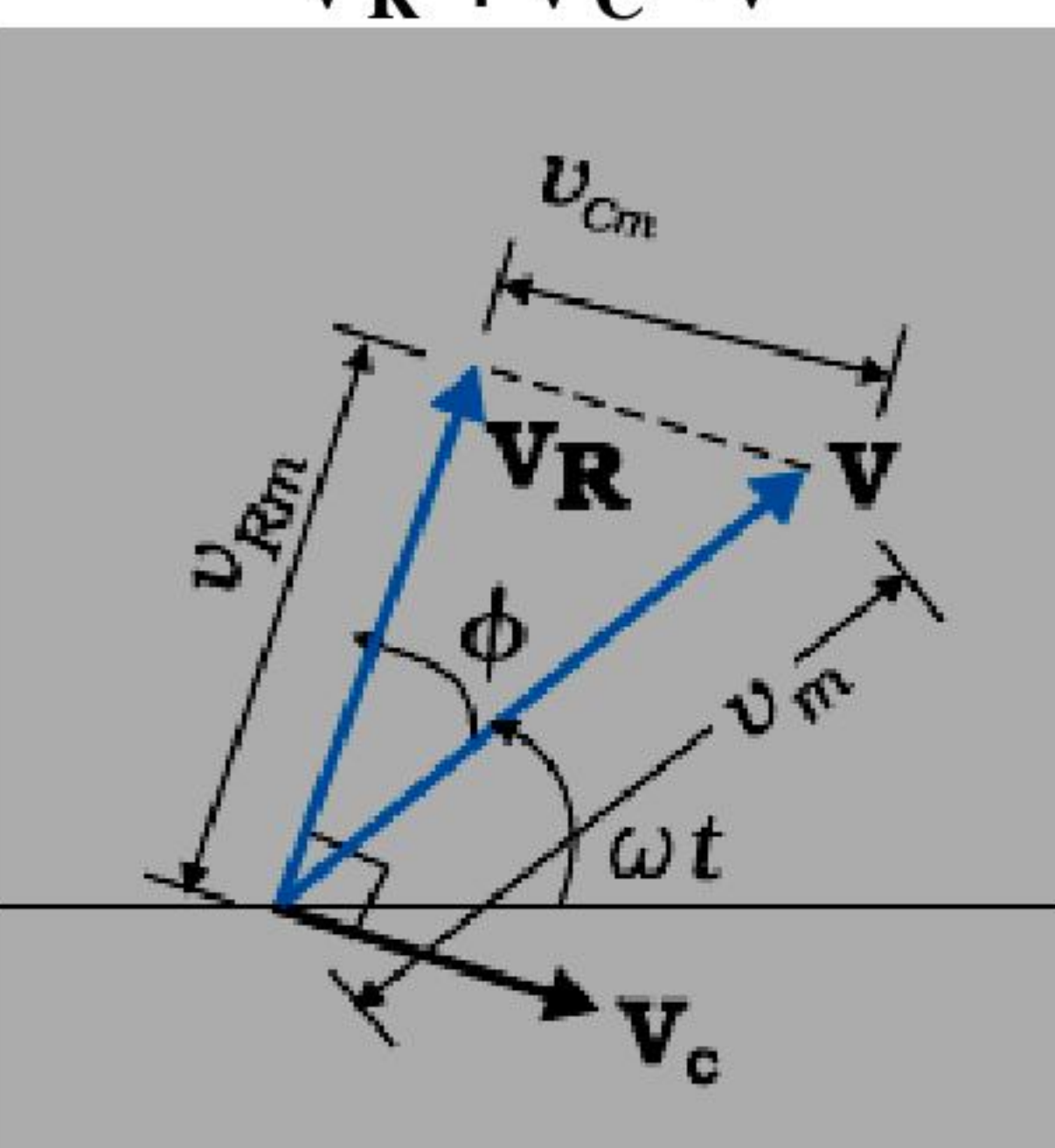
<p>Set1,Q14 Set2,Q22 Set3,Q19</p>	<p>Circuit diagram $\frac{1}{2}$ Phasor Diagram $\frac{1}{2}$ Obtaining the expression for: (i) Impedence $1 \frac{1}{2}$ (ii) Phase angle $\frac{1}{2}$</p> <p>The circuit diagram and the phasor diagram, for the given circuit, are as shown.</p>   <p><u>Derivation:</u> The voltage equation, for the circuit, can be written as: $v_r + v_c = v$ The phasor relation, whose vertical component gives the above equation, is $V_R + V_C = V$</p>  <p>The Pythagoras theorem gives</p>	$\frac{1}{2}$	$\frac{1}{2}$
---	---	---------------	---------------

	$v_m^2 = v_{RM}^2 + v_{cm}^2$ <p>Substituting the values of v_{RM} and v_{cm}, into this equation, gives</p> $v_m^2 = (i_m R)^2 + (i_m X_C)^2 = i_m^2 (R^2 + X_C^2)$ $\therefore i_m = \frac{v_m}{\sqrt{R^2 + X_C^2}}$ <p>\therefore The impedance of the circuit is given by:</p> $Z = \sqrt{R^2 + X_C^2} = \sqrt{R^2 + \frac{1}{\omega^2 C^2}}$ <p>The phase angle ϕ is the angle between V_R and V. Hence</p> $\tan \phi = \frac{X_C}{R} = \frac{1}{\omega C R}$	1/2									
		1/2									
		1/2	3								
Set1,Q15 Set2,Q11 Set3,Q20	<table border="1"> <tbody> <tr> <td>(i) Formula for magnetic moment</td> <td>1/2</td> </tr> <tr> <td>Calculation of magnetic moment</td> <td>1</td> </tr> <tr> <td>(ii) Formula for torque</td> <td>1/2</td> </tr> <tr> <td>Calculation of torque</td> <td>1</td> </tr> </tbody> </table> <p>(i) Associated magnetic moment $\mu_m = niA$ $= 2000 \times 4 \times 1.6 \times 10^{-4} \text{ A} - \text{m}^2$ $= 1.28 \text{ A} - \text{m}^2$</p> <p>(ii) torque $= \mu_m B \sin \theta$ $= 1.28 \times 7.5 \times 10^{-2} \times \sin 30^\circ$ $= 0.048 \text{ N} - \text{m}$</p>	(i) Formula for magnetic moment	1/2	Calculation of magnetic moment	1	(ii) Formula for torque	1/2	Calculation of torque	1	1/2 1/2 1/2	
(i) Formula for magnetic moment	1/2										
Calculation of magnetic moment	1										
(ii) Formula for torque	1/2										
Calculation of torque	1										
		1/2 1/2 1/2	3								
Set1,Q16 Set2,Q12 Set3,Q21	<table border="1"> <tbody> <tr> <td>(a) Formula</td> <td>1/2</td> </tr> <tr> <td>Calculation of the ratio</td> <td>1</td> </tr> <tr> <td>(b) Answering about Conservation of Energy</td> <td>1/2</td> </tr> <tr> <td>Explanation</td> <td>1</td> </tr> </tbody> </table> <p>(a) $\frac{I_{max}}{I_{min}} = \left \frac{a_1 + a_2}{a_1 - a_2} \right ^2$ Here $\frac{a_1}{a_2} = \sqrt{\frac{W_2}{W_1}} = \sqrt{\frac{4}{1}} = \frac{2}{1}$ $\therefore \frac{I_{max}}{I_{min}} = \left \frac{2a_2 + a_2}{2a_2 - a_2} \right ^2 = 9:1$</p> <p>(b) There is NO violation of the conservation of energy. The appearance of the bright and dark fringes is simply due to a 'redistribution of energy'.</p>	(a) Formula	1/2	Calculation of the ratio	1	(b) Answering about Conservation of Energy	1/2	Explanation	1	1/2 1/2 1/2 1/2	
(a) Formula	1/2										
Calculation of the ratio	1										
(b) Answering about Conservation of Energy	1/2										
Explanation	1										
		1	3								
Set1,Q17 Set2,Q13 Set3,Q22	<table border="1"> <tbody> <tr> <td>(a) Factors by which the resolving power can be increased.</td> <td>1</td> </tr> <tr> <td>(b) Formula</td> <td>1/2</td> </tr> <tr> <td>Estimation of angular separation</td> <td>1 1/2</td> </tr> </tbody> </table> <p>(a) The resolving power of a telescope can be increased by</p>	(a) Factors by which the resolving power can be increased.	1	(b) Formula	1/2	Estimation of angular separation	1 1/2				
(a) Factors by which the resolving power can be increased.	1										
(b) Formula	1/2										
Estimation of angular separation	1 1/2										

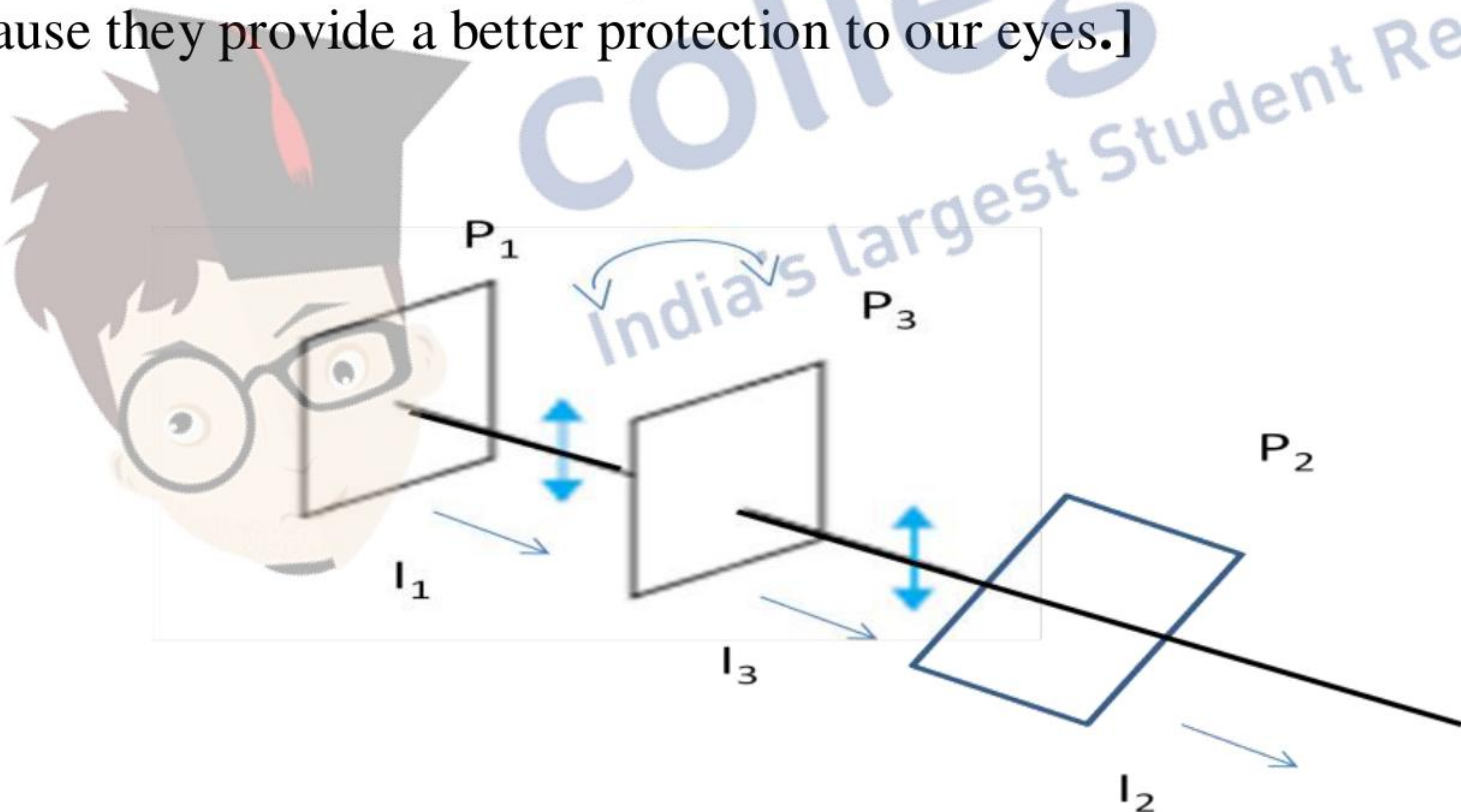

	(i) increasing the diameter of its objective (ii) using light of short wavelength [Note: Give full credit even if a student writes just the first of these two factors.]	1	
	(b) Position of Maxima: $\theta \approx \left(n + \frac{1}{2}\right) \frac{\lambda}{a}$; position of minima = $\frac{n\lambda}{a}$	1/2	
	For first order maxima, $\theta = \frac{3\lambda}{2a}$	1/2	
	and for third order minima, $\theta = \frac{3\lambda}{a}$		
	\therefore Required angular separation	1/2	
	$= \frac{3\lambda}{2a} = \frac{3 \times 600 \times 10^{-9}}{2 \times 1 \times 10^{-3}}$ radian	1/2	
	$= 9 \times 10^{-4}$ radian		3

Set1,Q18 Set2,Q14 Set3,Q11	<table border="1"> <tr> <td>(a) Reason for preferring sun glasses made up of polaroids</td> <td>1</td> </tr> <tr> <td>(b) Formula for intensity of light transmitted through P₂</td> <td>1 1/2</td> </tr> <tr> <td>Plot of I vs θ</td> <td>1/2</td> </tr> </table>	(a) Reason for preferring sun glasses made up of polaroids	1	(b) Formula for intensity of light transmitted through P ₂	1 1/2	Plot of I vs θ	1/2		
(a) Reason for preferring sun glasses made up of polaroids	1								
(b) Formula for intensity of light transmitted through P ₂	1 1/2								
Plot of I vs θ	1/2								
	<p>(a) Polaroid sunglasses are preferred because they can be much more effective than coloured sunglasses in cutting off the harmful (UV) rays of the sun. [Alternatively : Polaroid sun glasses are preferred over coloured sun glasses because they are more effective in reducing the glare due to reflections from horizontal surfaces.] [Alternatively : Polaroid sun glasses are preferred over coloured sun glasses because they provide a better protection to our eyes.]</p> <p>(b) </p> <p>Let θ be the angle between the pass axis of P₁ and P₃. The angle between the pass axis of P₃ and P₂ would then be $\left(\frac{\pi}{2} - \theta\right)$. By Malus' law,</p> $I_3 = I_1 \cos^2 \theta$ <p>and $I_2 = I_3 \cos^2 \left(\frac{\pi}{2} - \theta\right) = I_3 \sin^2 \theta$</p> $\therefore I_2 = I_1 \cos^2 \theta \sin^2 \theta = \frac{I_1 (\sin 2\theta)^2}{4}$ <p>The plot of I_2 vs θ, therefore, has the form shown below:</p>	1 1/2 1/2							

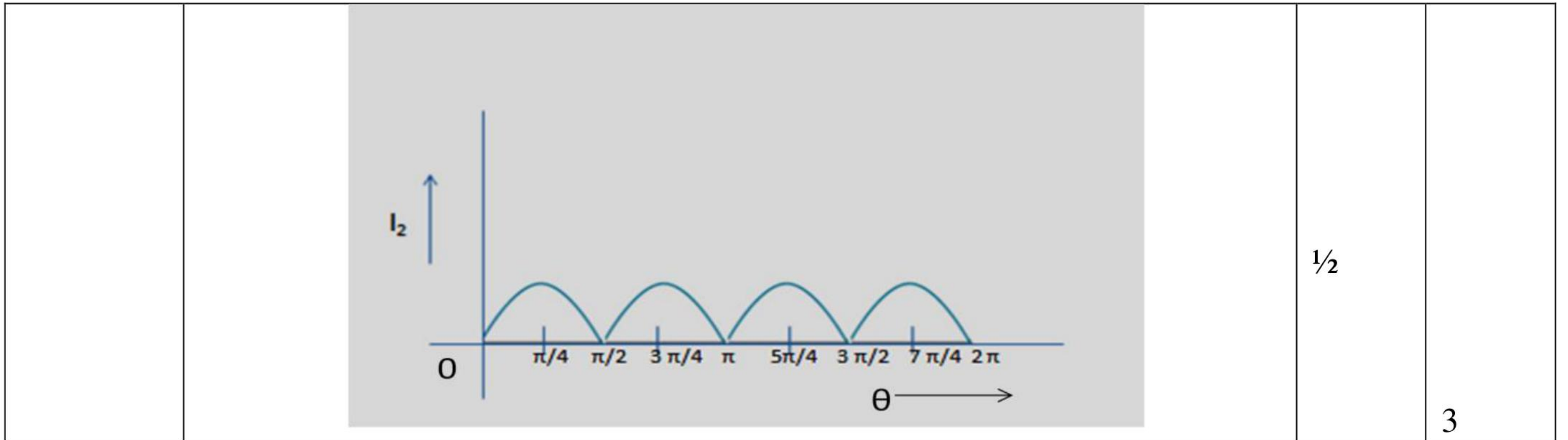

1/2

3

Set1,Q19
Set2,Q15
Set3,Q12

- | | |
|---|-----------|
| (a) Completing the reactions | 1/2 + 1/2 |
| (b) Basic processes involved in β^- and β^+ decay | 1/2 + 1/2 |
| (c) Reason for difficulty in dejecting neutrinos | 1 |

(a) We have

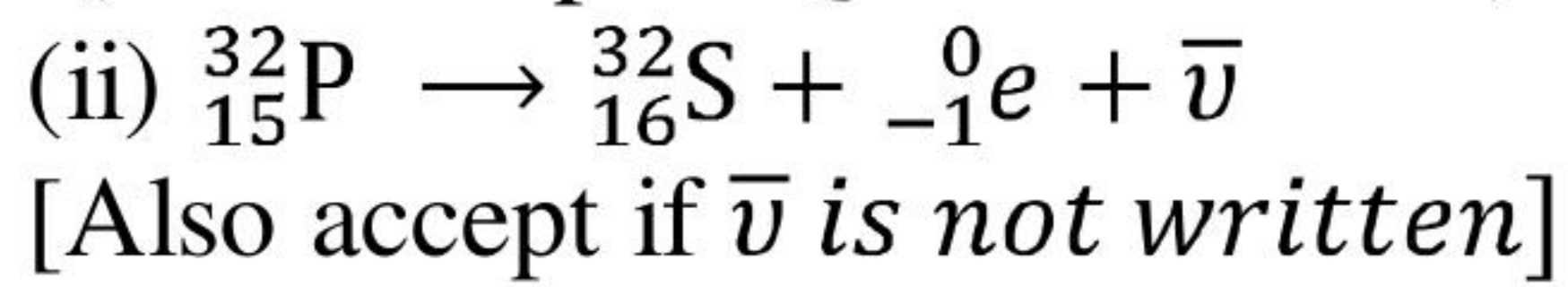
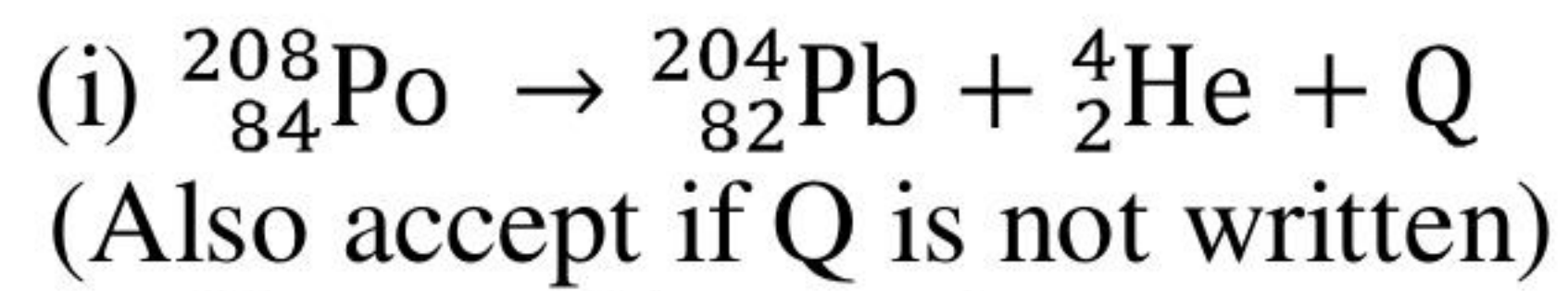

(b) The basic processes involved are

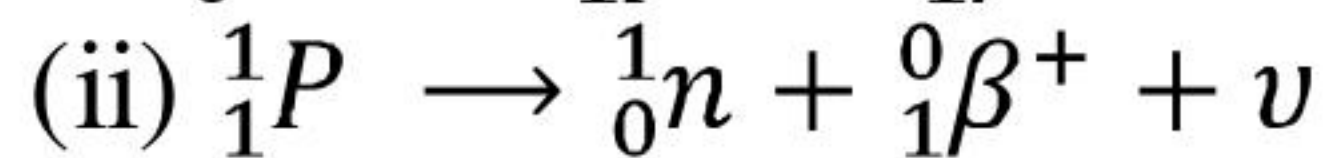
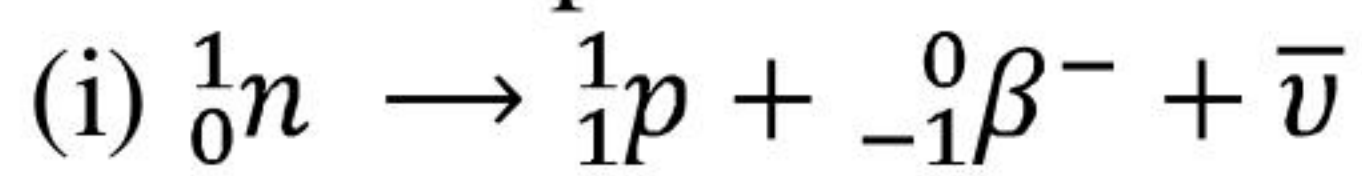

(c) Neutrinos are difficult to detect because:

- (i) they have only weak interactions with other particles
- (ii) they can penetrate large quantity of matter without any interaction.

[Any one]

1/2

1/2

1/2

1/2

1

3

Set1,Q20
Set2,Q16
Set3,Q13

- | | |
|---|-----------|
| Energy Band Diagrams | 1/2 + 1/2 |
| Explaining the role of donor and acceptor energy levels | 1+1 |

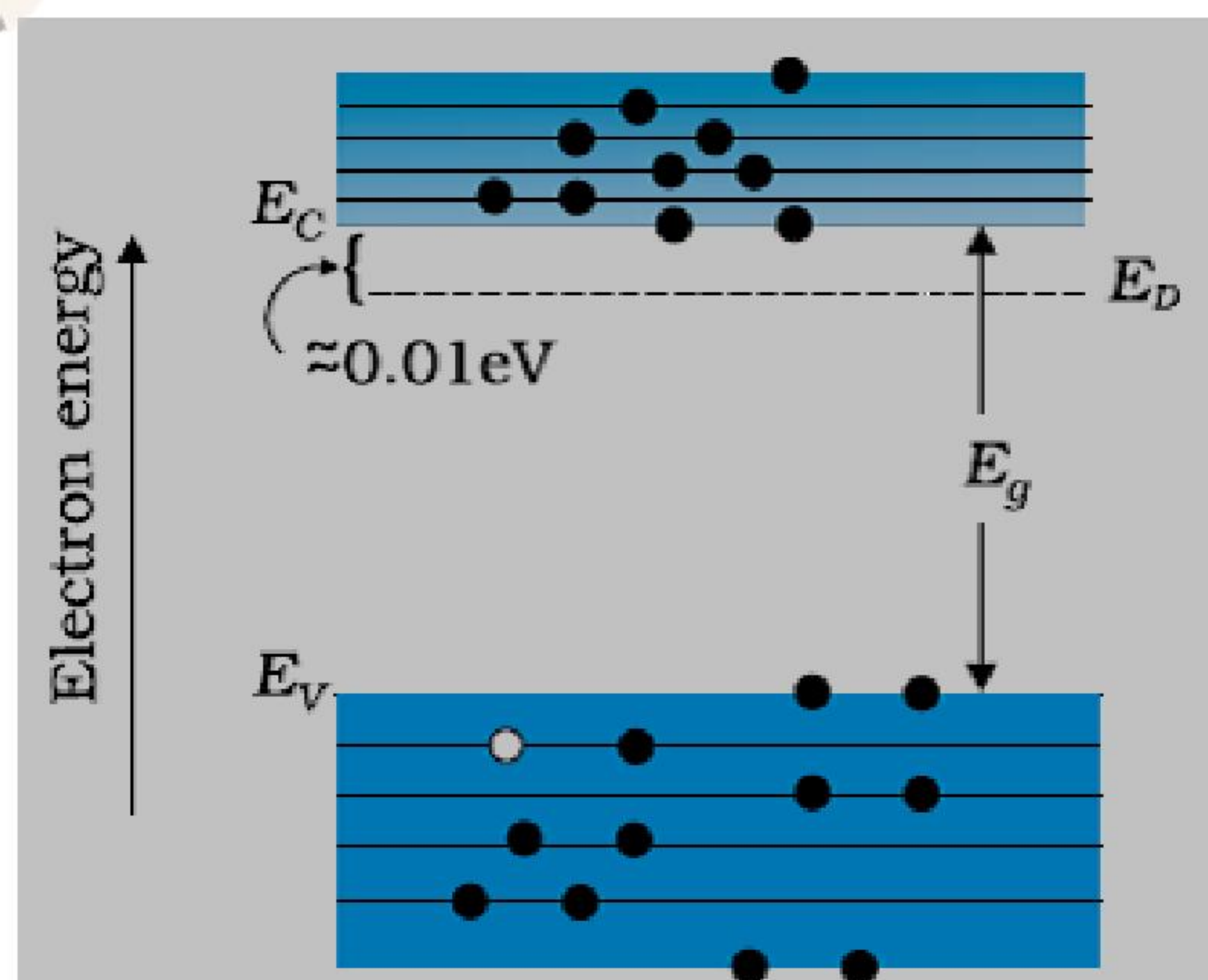

(i) n-type semiconductor at $T > 0\text{K}$

1/2



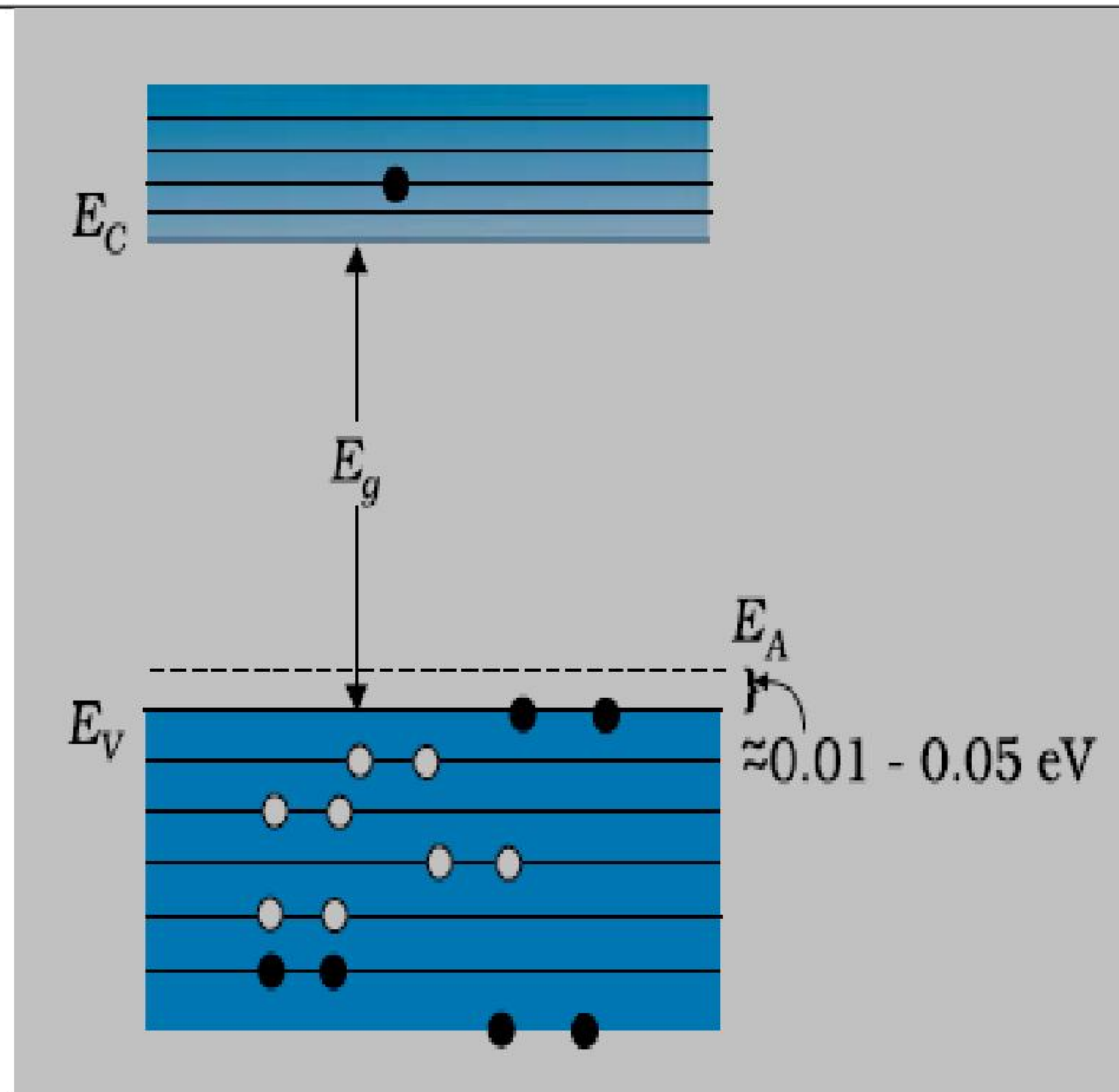

(ii) p-type semiconductor at $T > 0K$

For a n-type semiconductor

The electrons, from the donor impurity atoms, can move into the conduction band with very small supply of energy. The conduction band, therefore, has electrons as the majority charge carriers.

For a p-type semiconductor

In these semiconductors, a very small supply of energy can cause an electron from its valence band to jump to the acceptor energy level. The valence band, therefore, has a dominant density of holes in it. This effectively implies that the holes are the majority charge carriers in a p-type semiconductor.

1/2

1

1

3

Set1,Q21
Set2,Q17
Set3,Q14

Plot of transfer characteristics; use & reason	1/2 + 1/2
Circuit diagram	1
Working	1

The transfer characteristic has the form shown:

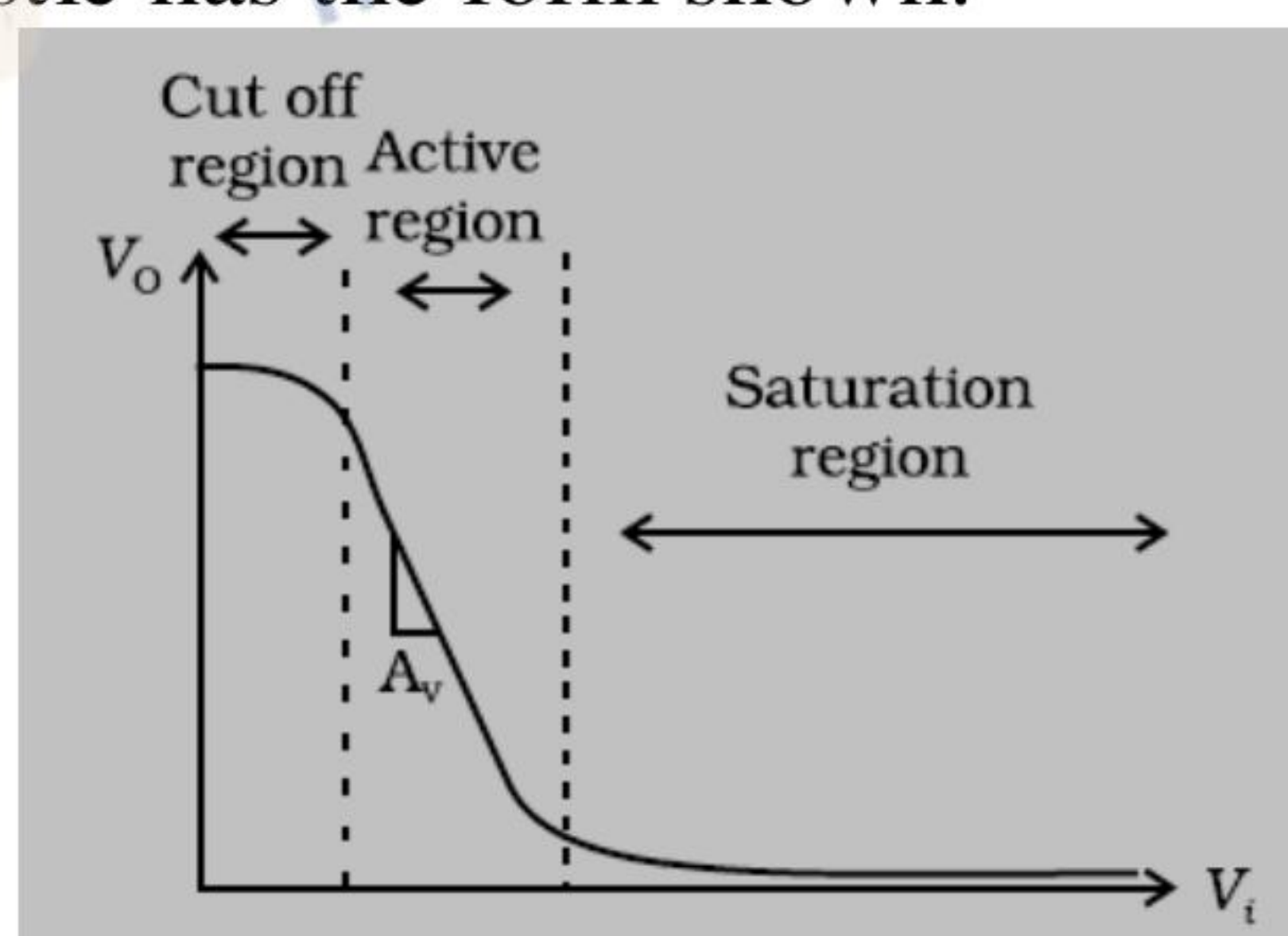

The Active Region of the transfer characteristic is used for amplification because in this region, I_C increases almost linearly with increase of V_i

The circuit diagram of the base biased transistor amplifier, in CE configuration, is shown below:

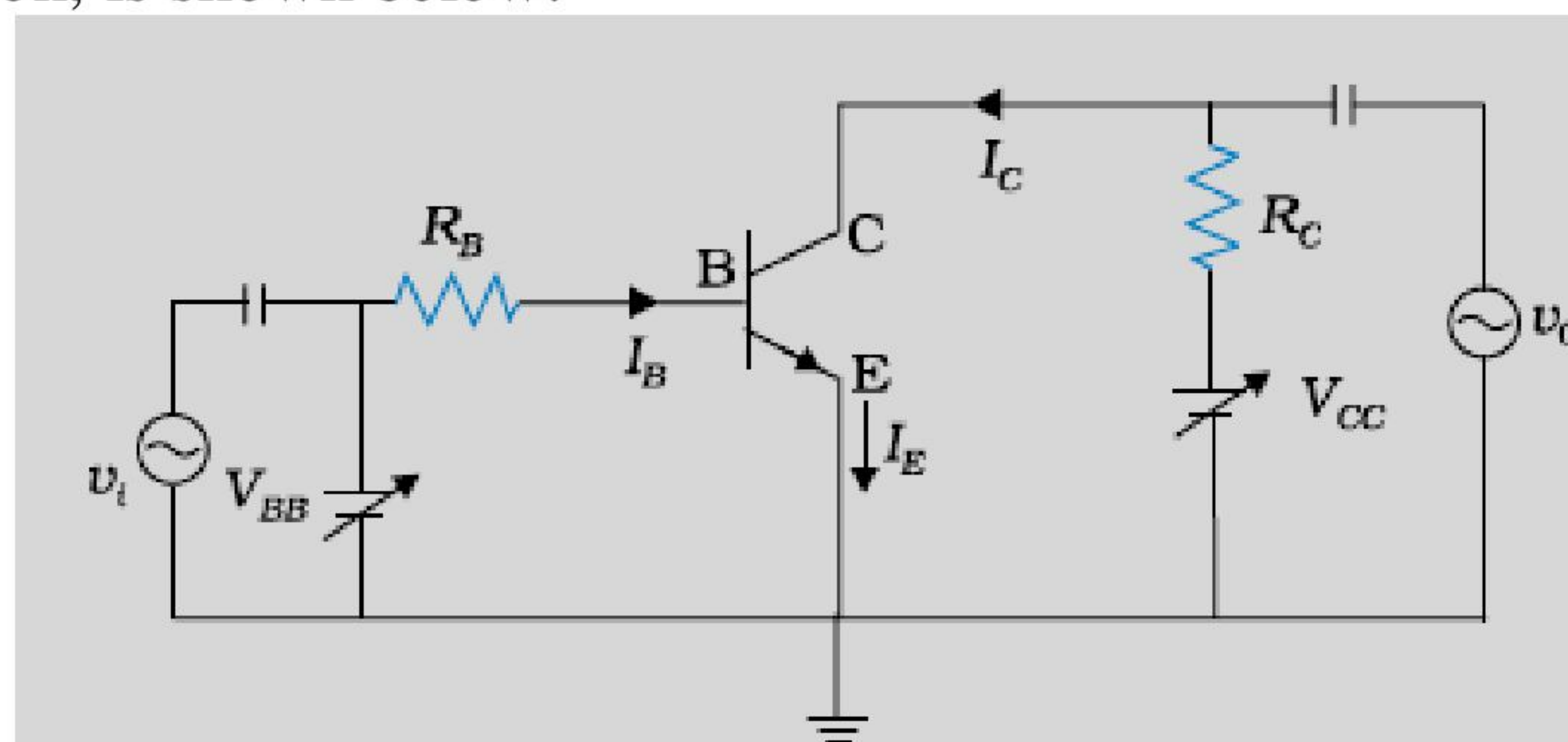

1/2

1/2

1



	<p>Working: The sinusoidal voltage, superposed on the dc base bias, causes the base current to have sinusoidal variations.</p> <p>As a result the collector current, also has similar sinusoidal variations present in it.</p> <p>The output, between the collector and the ground, is an amplified version of the input sinusoidal voltage.</p> <p>(Also accept 'other forms' for explanation of 'working')</p>	1	3										
Set1,Q22 Set2,Q18 Set3,Q15	<table border="1"> <tr> <td>Explanation of each of three terms</td> <td>1+1+1</td> </tr> </table> <p>(i) Internet Surfing Visiting, or using, the different websites on the internet.</p> <p>(ii) Social networking Social networking implies using site like (a) Facebook, Twitter, etc, to share ideas and information with a large number of people. (b) Using internet for chatting, video sharing, etc, among friends and acquaintances.</p> <p>(Any one)</p> <p>(iii) E-mail Using internet(rather than the post office) for exchanging (multimedia) communication between different persons and organizations.</p>	Explanation of each of three terms	1+1+1	1 1 1	3								
Explanation of each of three terms	1+1+1												
Section D													
Set1,Q23 Set2,Q23 Set3,Q23	<table border="1"> <tr> <td>(1) Value displayed by Dr. Kapoor Bimla's parents</td> <td>1+1</td> </tr> <tr> <td>(2) Reason for safety</td> <td>1</td> </tr> <tr> <td>(3) Definition and Significance</td> <td>½ + ½</td> </tr> </table> <p>(1) Dr. Kapoor : Helpful & Considerate Bimla's Parents: Gratefulness</p> <p>(2) It is considered safe to be inside a car during lightening and thunderstorm as the electric field inside a conductor is zero.</p> <p>(3) Dielectric strength of a dielectric indicates the strength of the electric field that a dielectric can withstand without breaking down. This signifies the maximum electric field up to which the dielectric can safely play its role.</p>	(1) Value displayed by Dr. Kapoor Bimla's parents	1+1	(2) Reason for safety	1	(3) Definition and Significance	½ + ½	1 1 1 ½ ½	4				
(1) Value displayed by Dr. Kapoor Bimla's parents	1+1												
(2) Reason for safety	1												
(3) Definition and Significance	½ + ½												
Section E													
Set1,Q24 Set2,Q26 Set3,Q25	<table border="1"> <tr> <td>(a) Statement of Lenz's law</td> <td>1</td> </tr> <tr> <td>Predicting the polarity</td> <td>1</td> </tr> <tr> <td>(b) (i) Formula</td> <td>½</td> </tr> <tr> <td>Substitution and Calculation</td> <td>1½</td> </tr> <tr> <td>(ii) Effect on voltage</td> <td>1</td> </tr> </table> <p>(a) Lenz's law: The polarity of induced emf is such that it tends to produce a current which opposes the change in magnetic flux that produced it.</p>	(a) Statement of Lenz's law	1	Predicting the polarity	1	(b) (i) Formula	½	Substitution and Calculation	1½	(ii) Effect on voltage	1	1	
(a) Statement of Lenz's law	1												
Predicting the polarity	1												
(b) (i) Formula	½												
Substitution and Calculation	1½												
(ii) Effect on voltage	1												



Polarity A → (+ve); B → (-ve)

(b) (i) $V = Blv$

Here B = vertical component of Earth's magnetic field

$$B = (5 \times 10^{-4} \sin 30^\circ) T = 2.5 \times 10^{-4} T$$

$$\therefore V = \left[2.5 \times 10^{-4} \times 25 \times \frac{1800 \times 10^3}{60 \times 60} \right] \text{ volt}$$

$$= 3.125 \text{ volt}$$

(ii) Now B = horizontal component of Earth's magnetic field

$$= B \cos 30^\circ = \frac{B\sqrt{3}}{2}$$

$$\therefore V' = \sqrt{3}V = 1.732 \times 3.125 \text{ volt} \cong 5.4 \text{ volt}$$

OR

Definition of mutual inductance	1
Factors affecting mutual inductance	1
Formulae for the three cases	1/2
Calculations for plotting the graphs	1
Plots of three graphs	1/2 + 1/2 + 1/2

Mutual Inductance:

The mutual inductance, of a pair of coils, equals the magnetic flux linked with one of them due to a unit current in the other.

Alternatively, The mutual inductance, of a pair of coils, equals the emf induced in one of them when the rate of change of current in the other is unity.

Factors affecting the mutual inductance of a pair of coils

- The sizes of the two coils
- The shape of the two coils
- the distance of separation between the two coils
- The nature of the medium between the two coils
- The relative orientation of the two coils.

[NOTE: Any two]

From $t = 0$ to $t = 3s$ ($= \frac{30 \text{ cm}}{10 \text{ cm/s}}$), the flux through the coil is zero.

From $t = 3s$ to $t = 5s$, the flux through the coil increases from 0 to $\left[0.1 \times \left(\frac{20}{100} \right)^2 \right]$ Wb, ie 0.004 Wb.

From $t = 5s$ to $t = 11s$, the flux remains constant at the value 0.004 Wb.

From $t = 11s$ to $t = 13s$, the flux through the coil remains zero.

(i) The plot of ϕ against t is, therefore, as shown:

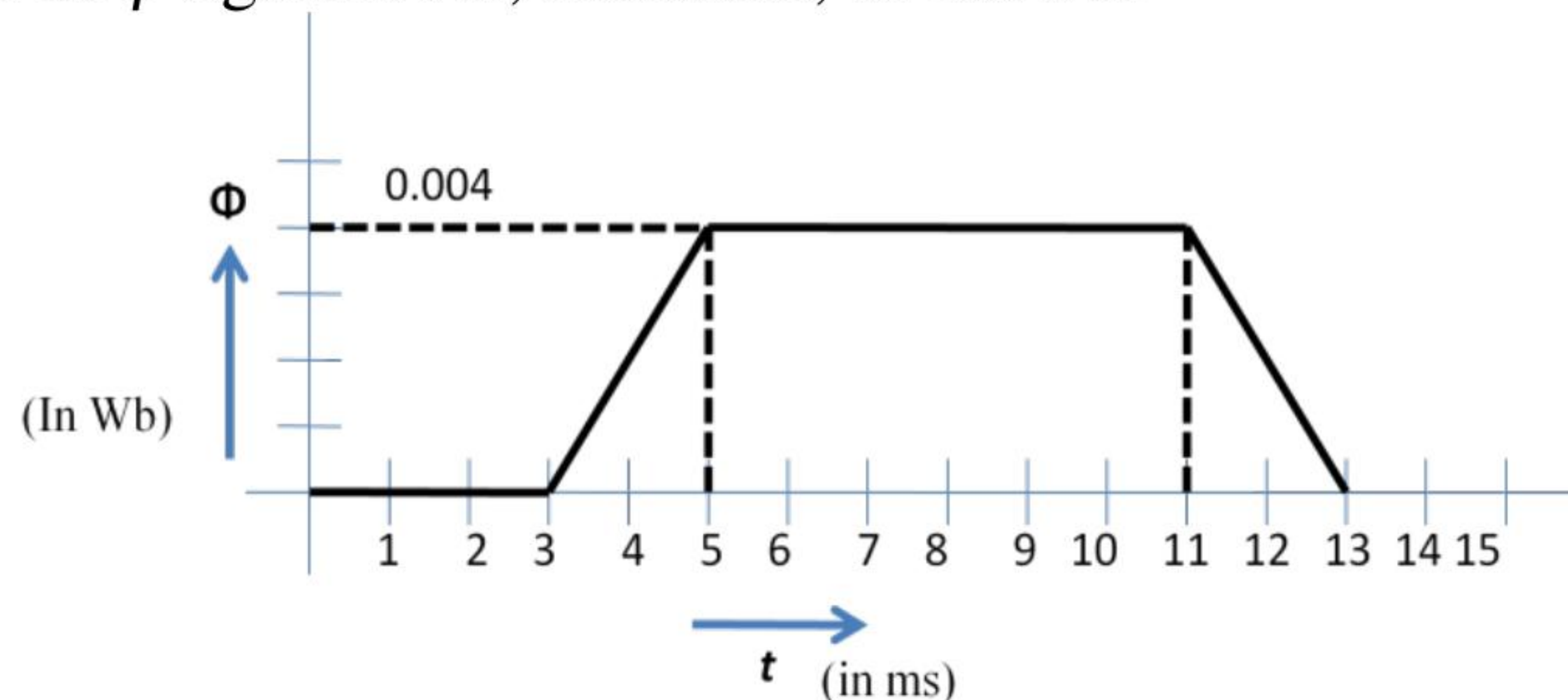

(ii) $\varepsilon = -\frac{d\phi}{dt}$

1/2 + 1/2

1/2

1/2

1/2

1/2

1/2

1/2

5

1

1/2 + 1/2

1



The plot of ε against t is, therefore, as shown:

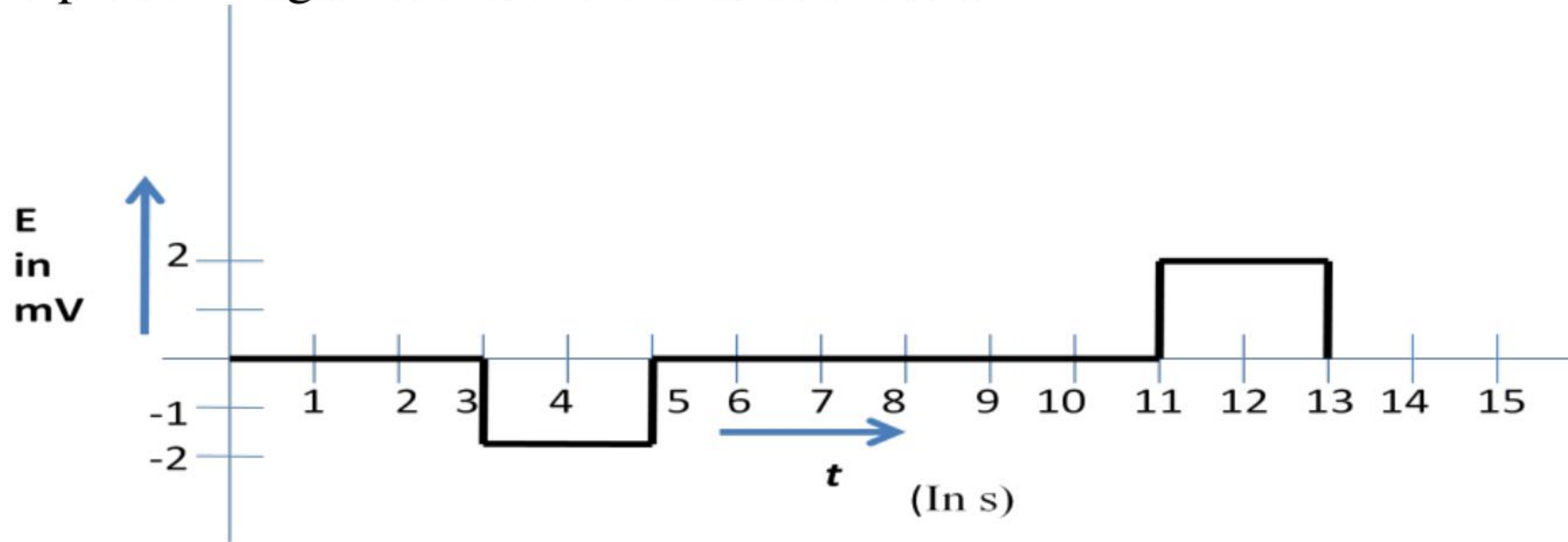

$$(iii) i = \frac{\varepsilon}{R} = \frac{2 \times 10^{-3}}{0.1 \Omega} = 20 \text{ mA}$$

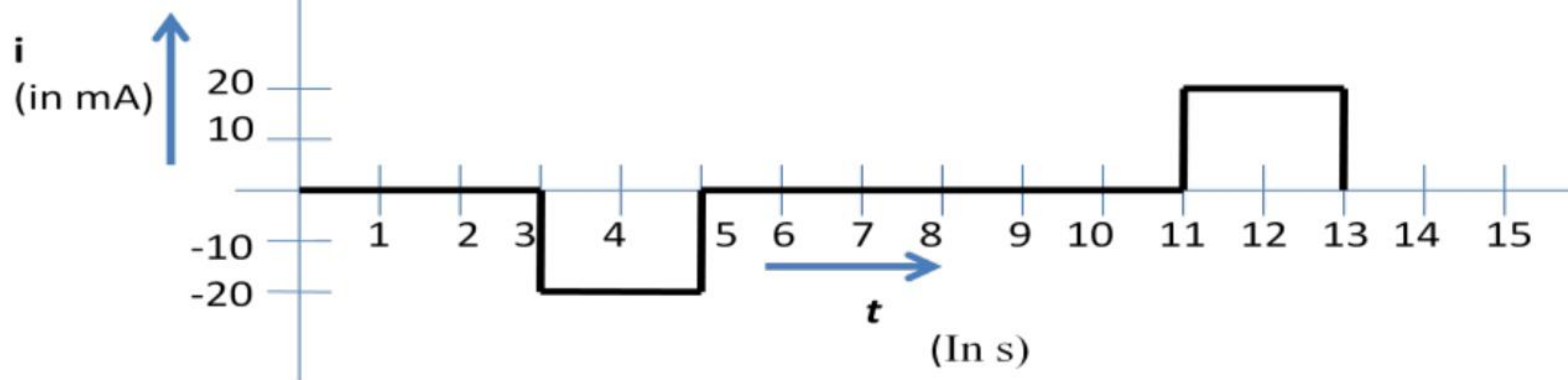

1

1

5

Set1, Q25
Set2, Q24
Set3, Q26

- | | |
|---|-------|
| (a) Definition of wavefront | 1 |
| Difference from a ray | 1 |
| (b) Shape of the wavefront in three cases | 1+1+1 |

(a) A wavefront is defined as a surface of constant phase.

[**Alternatively:** A wavefront is the locus of all points in the medium that have the same phase.]

Difference from a ray:

(i) The ray, at each point of a wavefront, is normal to the wavefront at that point.

(ii) The ray indicates the direction of propagation of wave while the wavefront is the surface of constant phase.

(Any one)

(b) The shape of the wavefront, in the three cases, are as shown.

(i)

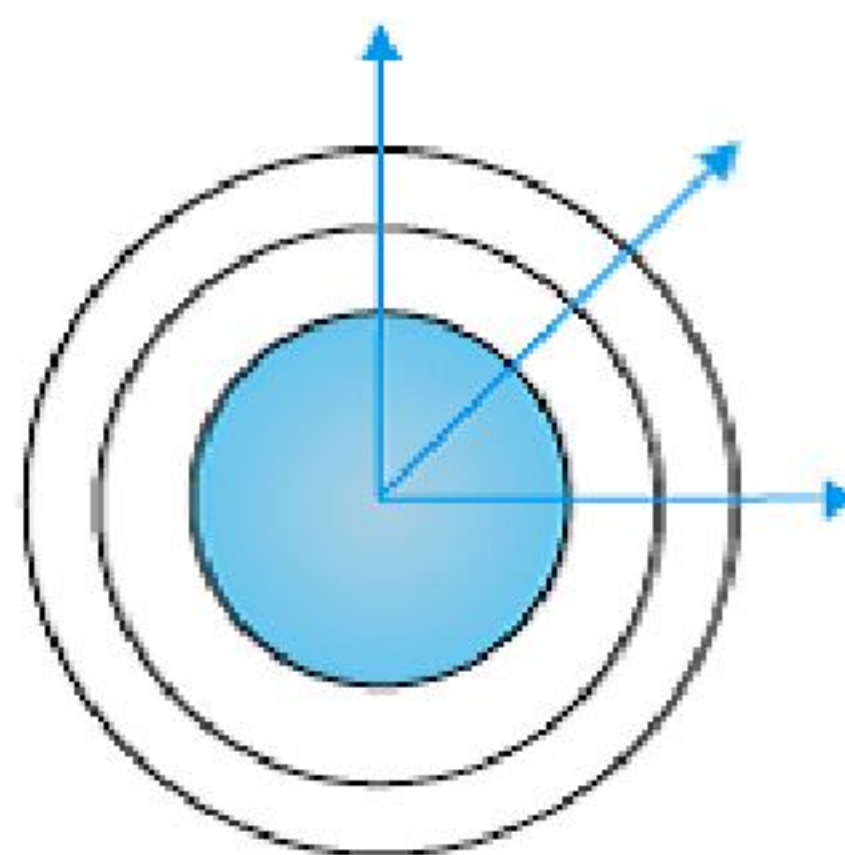

(ii)

1

1

1

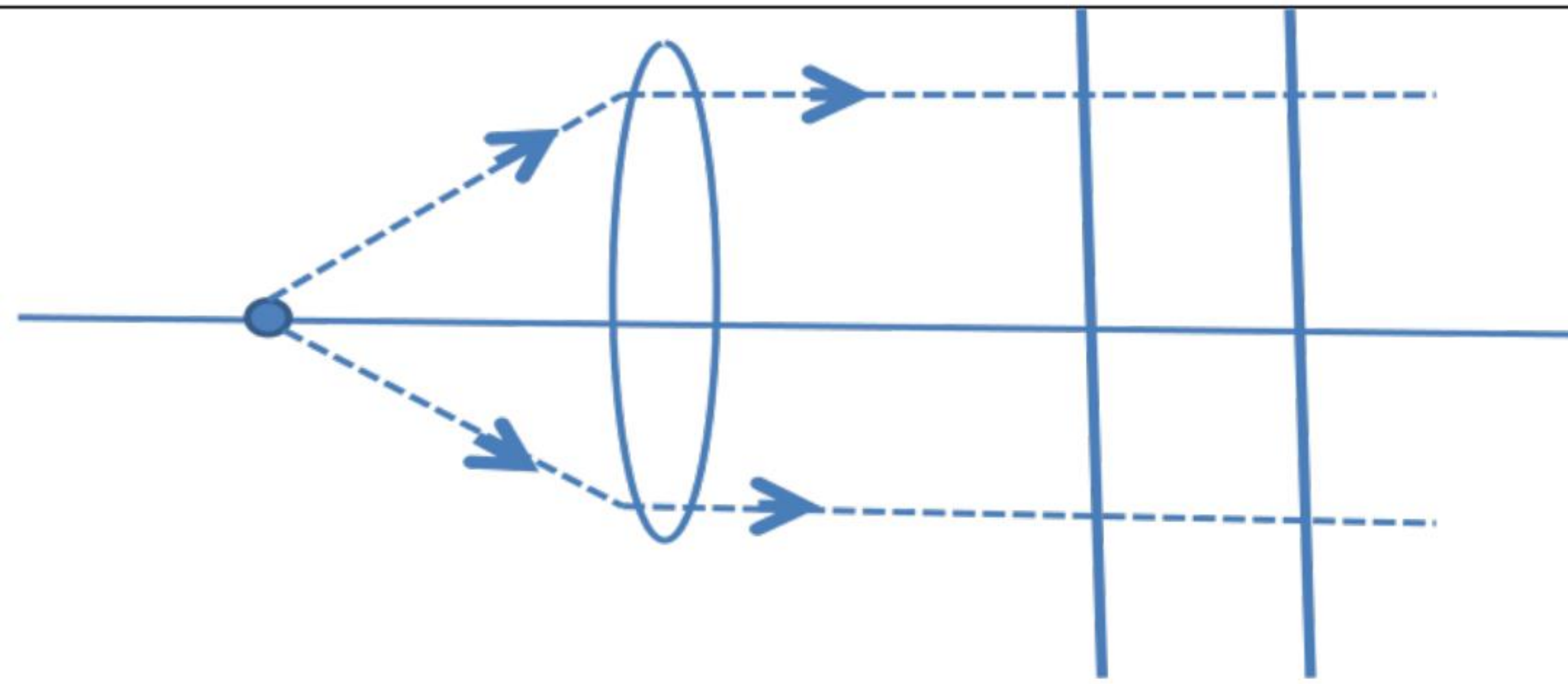

(iii)

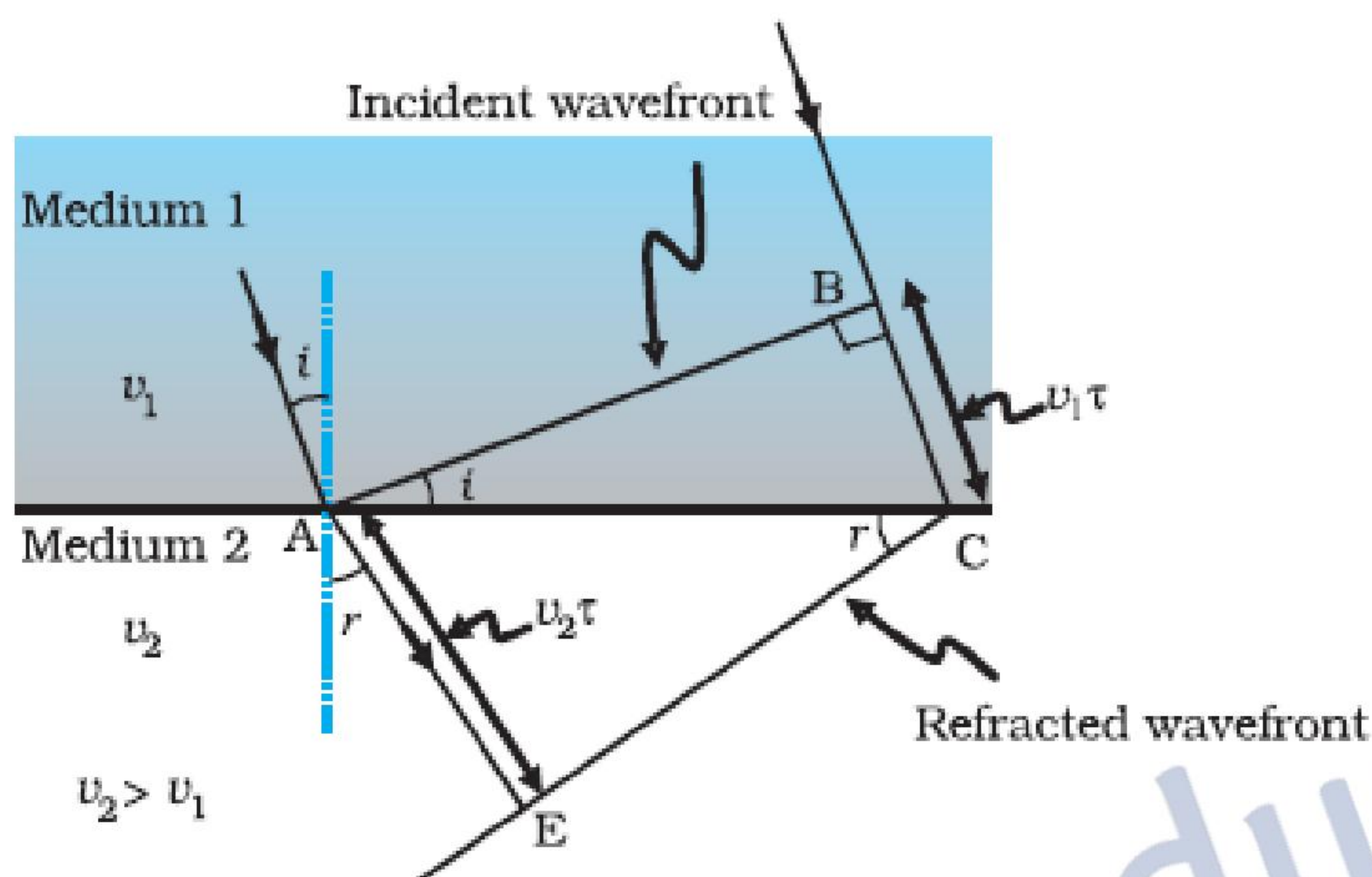

OR

(a) Ray diagram of compound microscope	1
Expression for total magnification	2
(b) Effect on resolving power in cases (i) and (ii)	$\frac{1}{2} + \frac{1}{2}$
Reasons for each case	$\frac{1}{2} + \frac{1}{2}$

(a) The ray diagram, showing image formation by a compound microscope, is given below:

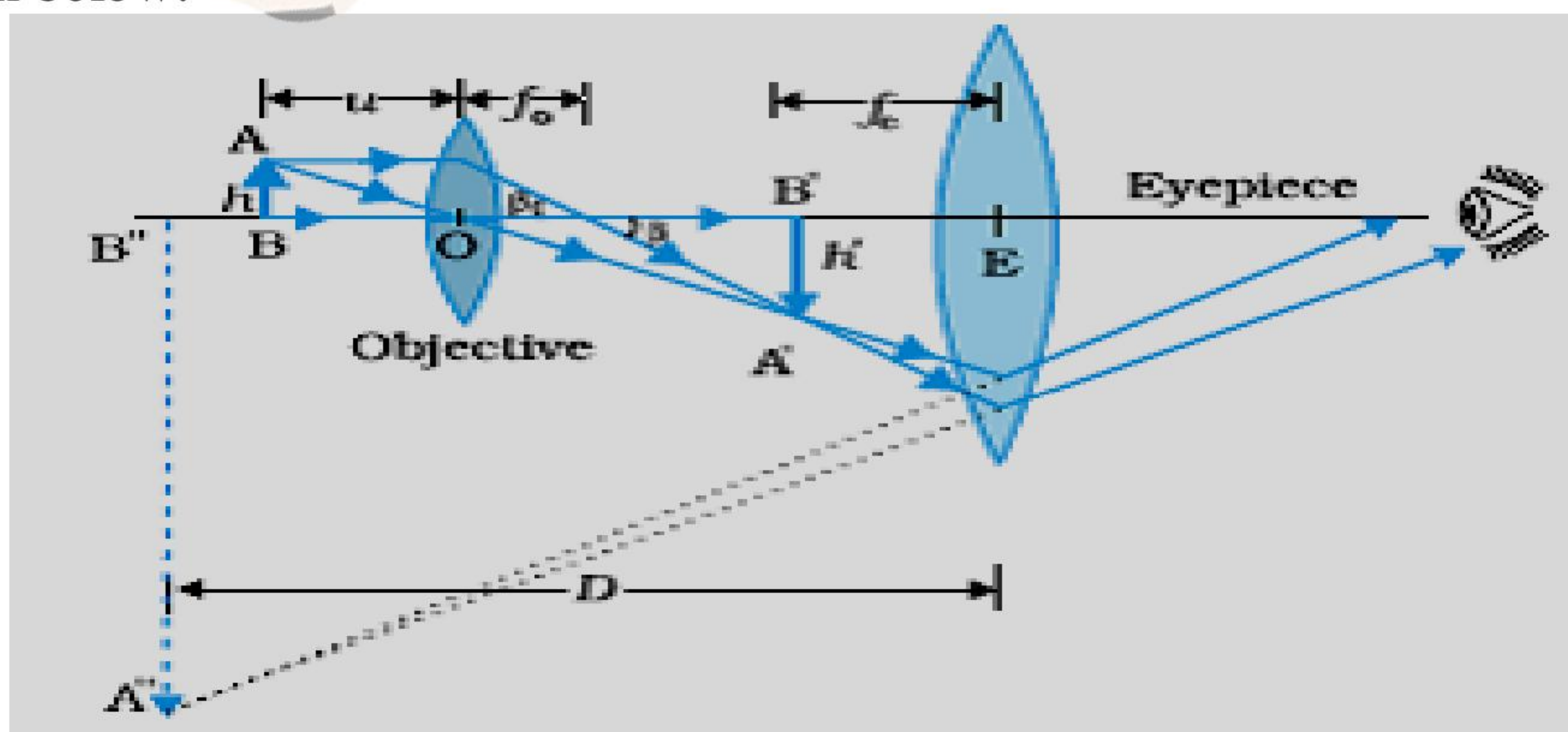

$$\text{Linear magnification due to the objective} = \frac{h'}{h} = \frac{L}{f_o}$$

$$\left(\because \tan \beta = \frac{h}{f_o} = \frac{h'}{L} \right)$$

Here L=tube length=distance between the second focal point of the objective and the first focal point of the eyepiece.



	<p>When the final image is formed at infinity, the angular magnification due to the eye piece equals $\frac{D}{f_e}$. (D=least distance of distinct vision)</p> <p>\therefore Total magnification when the final image is formed at infinity = $\left(\frac{L}{f_o} \cdot \frac{D}{f_e}\right)$</p> <p>(c) (i) Resolving power increases when the focal length of the objective is decreased.</p> <p>(d) This is because the minimum separation, $d_{min} \left(= \frac{1.22 f \lambda}{D}\right)$ decreases when f is decreased.</p> <p>(ii) Resolving power decreases when the wavelength of light is increased. This is because the minimum separation, $d_{min} \left(= \frac{1.22 f \lambda}{d}\right)$ increases when λ is increased.</p>	<p>$\frac{1}{2}$</p> <p>$\frac{1}{2}$</p> <p>$\frac{1}{2}$</p> <p>$\frac{1}{2}$</p> <p>$\frac{1}{2}$</p> <p>$\frac{1}{2}$</p>	<p>5</p>								
<p>Set1,Q26 Set2,Q25 Set3,Q24</p>	<table border="1" style="width: 100%; border-collapse: collapse;"> <tr> <td style="width: 60%;">(a) Writing three features</td> <td style="text-align: right;">$\frac{1}{2} + \frac{1}{2} + \frac{1}{2}$</td> </tr> <tr> <td>Explanation on the basis of Einstein's photoelectric equation</td> <td style="text-align: right;">$\frac{1}{2} + \frac{1}{2} + \frac{1}{2}$</td> </tr> <tr> <td>(b) (i) Reason for equality of the two slopes</td> <td style="text-align: right;">1</td> </tr> <tr> <td>(ii) Identification of material</td> <td style="text-align: right;">1</td> </tr> </table> <p>(a) Three features, of photoelectric effect, which cannot be explained by the wave theory of light, are:</p> <p>(i) Maximum kinetic energy of emitted electrons is independent of the intensity of incident light.</p> <p>(ii) There exists a 'threshold frequency' for each photosensitive material.</p> <p>(iii) 'Photoelectric effect' is instantaneous in nature.</p> <p>Einstein's photoelectric equation</p> $K_{max} = h\nu - \phi_o$ <p>[Alternatively: $eV_o = h\nu - \phi_o$] can be used to explain these features as follows.</p> <p>(i) Einstein's equation shows that $K_{max} \propto \nu$. However, K_{max} does not depend on the intensity of light.</p> <p>(ii) Einstein's equation shows that for $\nu < \frac{\phi_o}{h}$, K_{max} becomes negative, i.e., there cannot be any photoemission for $\nu < \nu_o$ ($\nu_o = \frac{\phi_o}{h}$)</p> <p>(iii) The free electrons in the metal, that absorb completely the energy of the incident photons, get emitted instantaneously.</p> <p>(b)</p> <p>(i) Slope of the graph between V_o and ν (from Einstein's equation) equals (h/e). Hence it does not depend on the nature of the material.</p> <p>(ii) Emitted electrons have greater energy for material M_1. This is because $\phi_o (= h\nu_o)$ has a lower value for material M_1.</p> <p style="text-align: center;">OR</p>	(a) Writing three features	$\frac{1}{2} + \frac{1}{2} + \frac{1}{2}$	Explanation on the basis of Einstein's photoelectric equation	$\frac{1}{2} + \frac{1}{2} + \frac{1}{2}$	(b) (i) Reason for equality of the two slopes	1	(ii) Identification of material	1	<p>$\frac{1}{2}$</p> <p>$\frac{1}{2}$</p> <p>$\frac{1}{2}$</p> <p>$\frac{1}{2}$</p> <p>$\frac{1}{2}$</p> <p>$\frac{1}{2}$</p> <p>$\frac{1}{2}$</p> <p>$\frac{1}{2}$</p> <p>1</p> <p>1</p>	<p>5</p>
(a) Writing three features	$\frac{1}{2} + \frac{1}{2} + \frac{1}{2}$										
Explanation on the basis of Einstein's photoelectric equation	$\frac{1}{2} + \frac{1}{2} + \frac{1}{2}$										
(b) (i) Reason for equality of the two slopes	1										
(ii) Identification of material	1										

(a) Drawing the Trajectory	1
Estimating the size of the nucleus	1
(b) Establishment of wave nature	1
(c) Estimating the ratio of deBroglie wavelengths	2

(a) The trajectory, traced by the α –particles in the Coulomb field of target nucleus, has the form shown below.

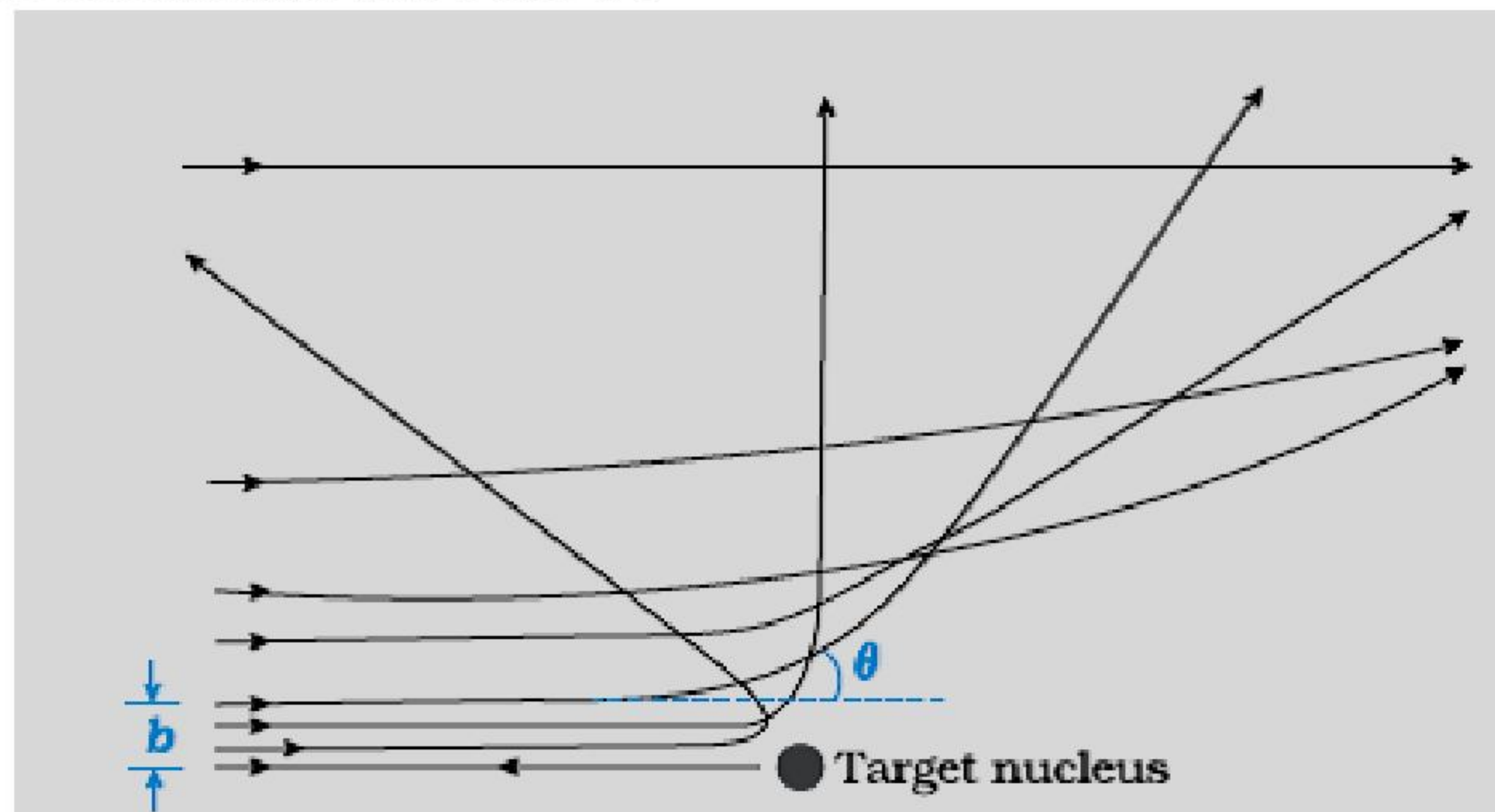

The size of the nucleus was estimated by observing the distance (d) of closest approach, of the α -particles. This distance is given by:

$$\frac{1}{4\pi\epsilon_0} \cdot \frac{(Ze)(2e)}{d} = K$$

where K =kinetic energy of the α -particles when they are far away from the target nuclei.

(b) The wave nature of moving electrons was established through the Davisson-Germer experiment.

In this experiment, it was observed that a beam of electrons, when scattered by a nickel target, showed ‘maxima’ in certain directions; (like the ‘maxima’ observed in interference/diffraction experiments with light.)

(c) We have: $\lambda = \frac{h}{p} = \frac{h}{\sqrt{2mqV}}$

$$\therefore \frac{\lambda_d}{\lambda_\alpha} = \frac{\sqrt{m_\alpha q_\alpha}}{\sqrt{m_d q_d}}$$

$$= \sqrt{2 \times 2} = 2$$

1

1

1/2

1/2

1/2 + 1/2

1/2

1/2

5