

**MARKING SCHEME
SET 55/1/P**

Q. No.	Expected Answer / Value Points	Marks	Total Marks
Section A			
Set-1, Q1 Set-2, Q5 Set-3, Q2	<p>The emf of a cell is equal to the terminal voltage when the circuit is open.</p> <p>Alternatively The emf of a cell is greater than the terminal voltage when current is drawn through the cell.</p> <p>Alternatively The emf of a cell is less than the terminal voltage when the cell is being charged.</p> <p>Alternatively $\varepsilon = V + ir$ $\varepsilon = V$ when $i = 0$ $\varepsilon > V$ when $i > 0$ $\varepsilon < V$ when $i < 0$</p> <p>Alternatively Emf of cell is work done by the cell force (of non-electrostatic origin) per unit charge, as charges are transferred through the cell.</p> <p>The terminal voltage is work done by the force of electric field per unit charge as charge move across the terminals of the cell through the external circuit.</p> <p>(Award this 1mark if the student distinguishes between emf and terminal voltage in any one of the ways given above)</p>	1 or 1 or 1 or 1 or 1	1
Set-1, Q2 Set-2, Q4 Set-3, Q5	<p>The kinetic energy of a negative charge <u>decreases</u> in going from point B to point A in the given field configuration.</p> <p>Alternatively Decreases</p>	1 or 1	1
Set-1, Q3 Set-2, Q2 Set-3, Q4	<p>A repeater picks up a signal, amplifies it, and re transmits it, thereby extending the range of a communication system.</p> <p>Alternatively Amplifies and retransmits the signal.</p>	1 Or 1	1
Set-1, Q4 Set-2, Q3 Set-3, Q1	<p>Concave Lens</p> <p>Alternatively It can be convex when the ambience is of higher refractive index. (Award one mark if the student writes the lens as a convex lens and gives the reason for this)</p>	1 Or 1	1

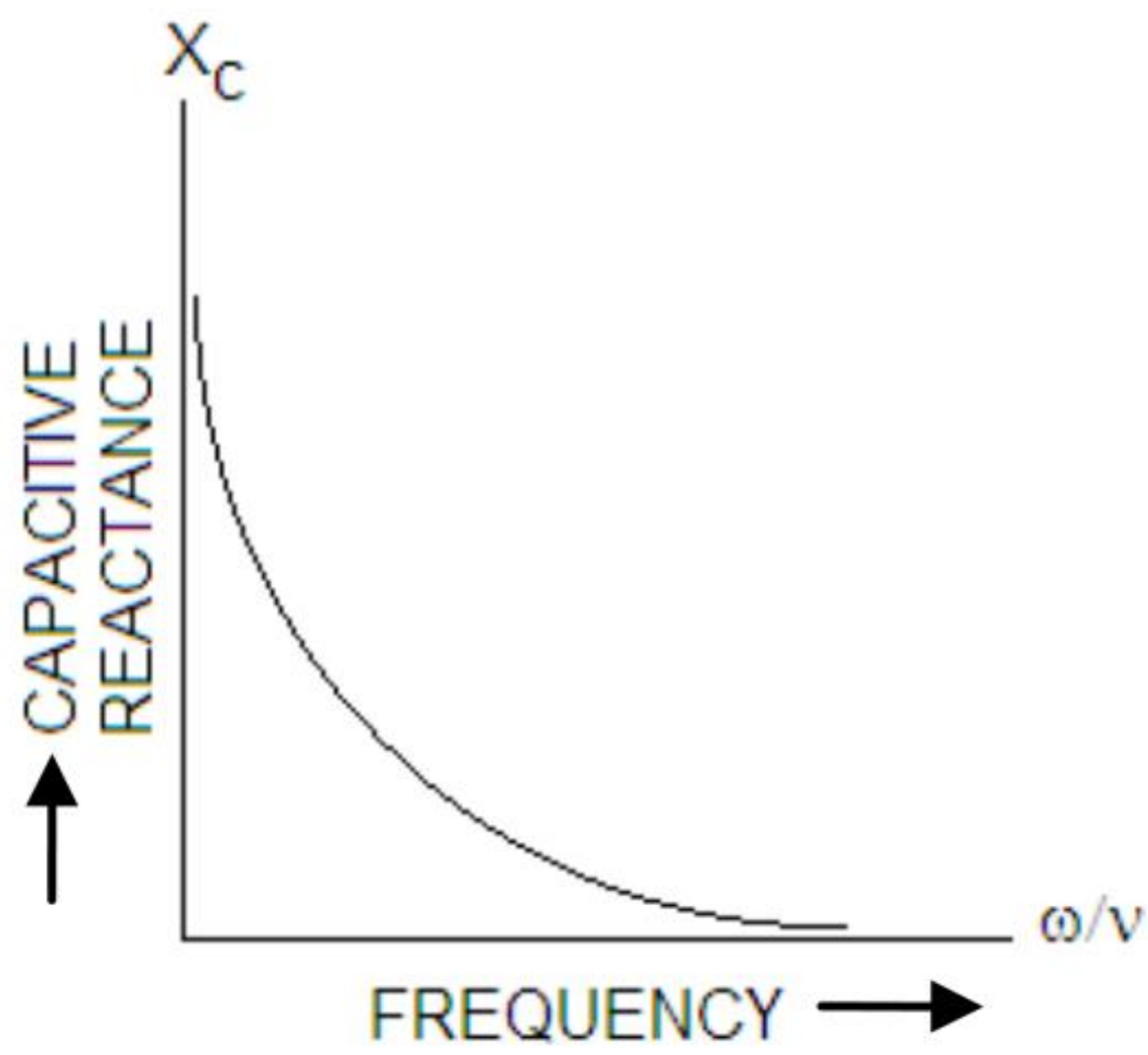

Set-1, Q5 Set-2, Q1 Set-3, Q3	 <p>(Award 1/2 mark if the student just writes $X_C = \frac{1}{\omega C}$ but does not draw the graph)</p>	1	1								
Section B											
Set-1, Q6 Set-2, Q7 Set-3, Q10	<table border="1" style="width: 100%;"> <tr> <td style="width: 60%;">Writing the two equations:</td> <td style="width: 40%; text-align: right;">1/2 + 1/2</td> </tr> <tr> <td>Values of R & S:</td> <td style="text-align: right;">1/2 + 1/2</td> </tr> </table> $\frac{R}{S} = \frac{40}{60} \Rightarrow 3R = 2S \text{ -----(i)}$ $\frac{R+10}{S} = \frac{60}{40} \Rightarrow 2R + 20 = 3S \text{ -----(ii)}$ <p>Simultaneously solving the equations we get $R = 8\Omega$ and $S = 12\Omega$</p>	Writing the two equations:	1/2 + 1/2	Values of R & S:	1/2 + 1/2	1/2 1/2 1/2 + 1/2					
Writing the two equations:	1/2 + 1/2										
Values of R & S:	1/2 + 1/2										
Set-1, Q7 Set-2, Q10 Set-3, Q8	<table border="1" style="width: 100%;"> <tr> <td style="width: 60%;">Writing $\mu = \frac{1}{\sin i_c}$</td> <td style="width: 40%; text-align: right;">1/2</td> </tr> <tr> <td>Calculating V</td> <td style="text-align: right;">1/2</td> </tr> <tr> <td>Writing Yes or Depends</td> <td style="text-align: right;">1/2</td> </tr> <tr> <td>Reason</td> <td style="text-align: right;">1/2</td> </tr> </table> $i + e = A + D$ $\frac{3}{4}A + \frac{3}{4}D = A + D$ $D = \frac{1}{2}A = \frac{1}{2} \times 60^\circ = 30^\circ$ <p>Or</p> $\mu = \frac{1}{\sin i_c} = \frac{1}{\sin 45^\circ} = \sqrt{2}$ $V = \frac{C}{\mu} = \frac{3 \times 10^8}{\sqrt{2}} \text{ m/s}$	Writing $\mu = \frac{1}{\sin i_c}$	1/2	Calculating V	1/2	Writing Yes or Depends	1/2	Reason	1/2	1 1/2 1/2 1/2	2
Writing $\mu = \frac{1}{\sin i_c}$	1/2										
Calculating V	1/2										
Writing Yes or Depends	1/2										
Reason	1/2										



	$= 2.1 \times 10^8 m/s$ (also accept $V = (\frac{3}{\sqrt{2}}) \times 10^8 m/s$) Yes (or Depends) Reason: μ depends upon λ , the wavelength of the incident light (or $\mu = A + \frac{B}{\lambda^2}$)	1/2 1/2	2						
Set-1, Q8 Set-2, Q6 Set-3, Q9	<table border="1" style="width: 100%;"> <tr> <td>Writing $2\pi r = n\lambda$</td> <td>1/2</td> </tr> <tr> <td>De Broglie formula $\lambda = \frac{h}{p}$</td> <td>1/2</td> </tr> <tr> <td>Getting Bohr's second postulate</td> <td>1</td> </tr> </table> <p>For a stationary state $2\pi r = n\lambda$(i) 1/2</p> <p>By De-Broglie hypothesis wavelength of electron-wave is $\lambda = \frac{h}{p}$(ii) 1/2</p> <p>Equation (i) and (ii) give $rp = n \frac{h}{2\pi}$ 1/2</p> <p>i.e. $l = \frac{nh}{2\pi}$ ($\because l = pr$) which is Bohr's second postulate of quantization of angular momentum. 1/2</p>	Writing $2\pi r = n\lambda$	1/2	De Broglie formula $\lambda = \frac{h}{p}$	1/2	Getting Bohr's second postulate	1	1/2 1/2 1/2 1/2	2
Writing $2\pi r = n\lambda$	1/2								
De Broglie formula $\lambda = \frac{h}{p}$	1/2								
Getting Bohr's second postulate	1								
Set-1, Q9 Set-2, Q8 Set-3, Q7	<p>In ground wave communication, the e.m. wave glides over the earth's surface.</p> <p>At high frequencies, the rate of energy dissipation of the signal increases and the signal gets attenuated over a short distance.</p> <p>Alternatively As the ground wave glides over the earth surface, its changing magnetic field induces an electric current, on the surface. At higher frequency the rate of variation (of magnetic field) is larger inducing a larger current, so energy dissipation of the signal is more. So the higher the frequency the more rapid is the signal alternation.</p>	1 1 or 1 1	2						
Set-1, Q10 Set-2, Q9 Set-3, Q6	<table border="1" style="width: 100%;"> <tr> <td>Photon: $h\nu = \frac{hc}{\lambda} = E$</td> <td>1/2</td> </tr> <tr> <td>Electron: $\lambda = \frac{h}{p}$</td> <td>1/2</td> </tr> <tr> <td>Calculating P</td> <td>1</td> </tr> </table> <p>Photon: $h\nu = E = \frac{hc}{\lambda}$ or $\lambda = \frac{hc}{E}$ 1/2</p> <p>Electron: $\lambda = \frac{h}{p}$ 1/2</p> <p>$\therefore \frac{h}{p} = \frac{hc}{E}$ or $p = \frac{E}{c} = 2 \times 10^{-25} kg ms^{-1}$ 1</p>	Photon: $h\nu = \frac{hc}{\lambda} = E$	1/2	Electron: $\lambda = \frac{h}{p}$	1/2	Calculating P	1	1/2 1/2 1	2
Photon: $h\nu = \frac{hc}{\lambda} = E$	1/2								
Electron: $\lambda = \frac{h}{p}$	1/2								
Calculating P	1								



Section C

Set-1, Q11
Set-2, Q20
Set-3, Q15

Finding Equivalent Capacitance	2
Finding Charge	$\frac{1}{2}$
Finding Energy	$\frac{1}{2}$

The equivalent setup is

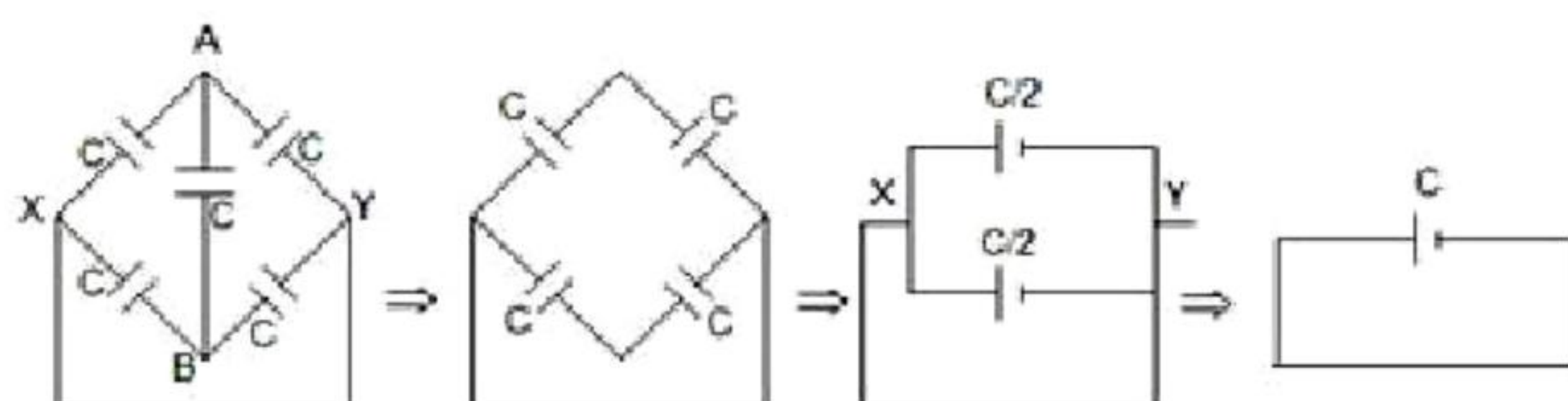

Here $V_A = V_B$ (A & B are at the same potential) so the bridge capacitor can be removed.

(i) $Q = CV = 6 \mu C$

(ii) $U = \frac{1}{2} qV = 18 \mu J$

NOTE:

- (i) In case the student gets an incorrect answer for the equivalent capacitance (C_{eq}) but uses his/her calculated value of C_{eq} to correctly calculate the
- (i) Charge and (ii) stored energy, award him/her $\frac{1}{2} + \frac{1}{2}$ marks respectively.
- (ii) If a student just writes the formulae $q = C_{eq} V$ and $u = \frac{1}{2} C_{eq} V^2$ but does not do the calculations, award him/her a total of $\frac{1}{2}$ marks for the second part of the question.

2

$\frac{1}{2}$

$\frac{1}{2}$

3

Set-1, Q12
Set-2, Q21
Set-3, Q16

Principle	1
Two Factors	$\frac{1}{2} + \frac{1}{2}$
Reason for preference	1

Principle: The potential drop, across a part of a length l of a uniform wire of length L ($L > l$), is proportional to the length l .

Two factors: (i) increasing the length L of the wire
(ii) connecting a suitable resistance, R , in series with the potentiometer wire.

Reason: At the balance position, there is no net current drawn, from the cell and the cell is effectively in an open circuit condition.

This is not so for a voltmeter.

1

$\frac{1}{2}$

$\frac{1}{2}$

$\frac{1}{2}$

$\frac{1}{2}$

3



Set-1, Q13 Set-2, Q22 Set-3, Q17	<table border="1"> <tbody> <tr> <td>(a) Definition</td> <td>1</td> </tr> <tr> <td>(b) (i) Number of photons comparison</td> <td>1/2</td> </tr> <tr> <td>Reason</td> <td>1/2</td> </tr> <tr> <td>(iii) Maximum K.E.</td> <td>1/2</td> </tr> <tr> <td>Reason</td> <td>1/2</td> </tr> </tbody> </table>	(a) Definition	1	(b) (i) Number of photons comparison	1/2	Reason	1/2	(iii) Maximum K.E.	1/2	Reason	1/2		
(a) Definition	1												
(b) (i) Number of photons comparison	1/2												
Reason	1/2												
(iii) Maximum K.E.	1/2												
Reason	1/2												
	<p>a) Intensity of radiation is determined by the number of photons incident per unit area per unit time.</p> <p>b) (i) Red Light Reason: Energy of photon of red light is less than that of a photon of blue light (Alternative $h\nu_{red} < h\nu_{blue}$)</p> <p>(ii) Blue Light Reason: Energy of photon of Blue light is more than that of a photon of red light (Alternative $h\nu_{blue} > h\nu_{red}$)</p> <p>Note: [If the student writes the Einstein's photoelectric equation: $h\nu = h\nu_0 + \frac{1}{2}mv_{max}^2$ Instead of the reason in part (ii) award him/her 1/2 mark only.]</p>	1 1/2 1/2 1/2 1/2	3										
Set-1, Q14 Set-2, Q16 Set-3, Q18	<table border="1"> <tbody> <tr> <td>(a) Two reasons</td> <td>1/2+1/2</td> </tr> <tr> <td>(b) Writing mirror equation</td> <td>1/2</td> </tr> <tr> <td>(c) Proving the given result</td> <td>1 1/2</td> </tr> </tbody> </table> <p>Reasons: Reflecting telescopes can be made to have</p> <p>(i) Larger light gathering power</p> <p>(ii) Better resolution (Also: less expensive; easier to design; free from aberrations) (any two)</p> $\frac{1}{v} + \frac{1}{u} = \frac{1}{f} \Rightarrow v = \frac{uf}{u-f} \dots\dots(i)$ <p>As 'u' is always -ve for a real object and 'f' is +ve for a convex mirror (as per Cartesian sign convention)</p> <p>∴ v is always +ve.</p> <p>Hence, the image is always on the other side of the mirror (and hence, virtual for all u)</p>	(a) Two reasons	1/2+1/2	(b) Writing mirror equation	1/2	(c) Proving the given result	1 1/2	1/2 1/2 1/2 1/2 1/2 1/2	3				
(a) Two reasons	1/2+1/2												
(b) Writing mirror equation	1/2												
(c) Proving the given result	1 1/2												
Set-1, Q15 Set-2, Q17 Set-3, Q11	<table border="1"> <tbody> <tr> <td>Statement of the law</td> <td>1</td> </tr> <tr> <td>Example</td> <td>1</td> </tr> <tr> <td>Numerical</td> <td>1</td> </tr> </tbody> </table> <p>Lenz's law applies to closed circuit determining the direction of induced current states "The induced emf will appear in such a direction that it opposes the change that produced it."</p>	Statement of the law	1	Example	1	Numerical	1	1					
Statement of the law	1												
Example	1												
Numerical	1												



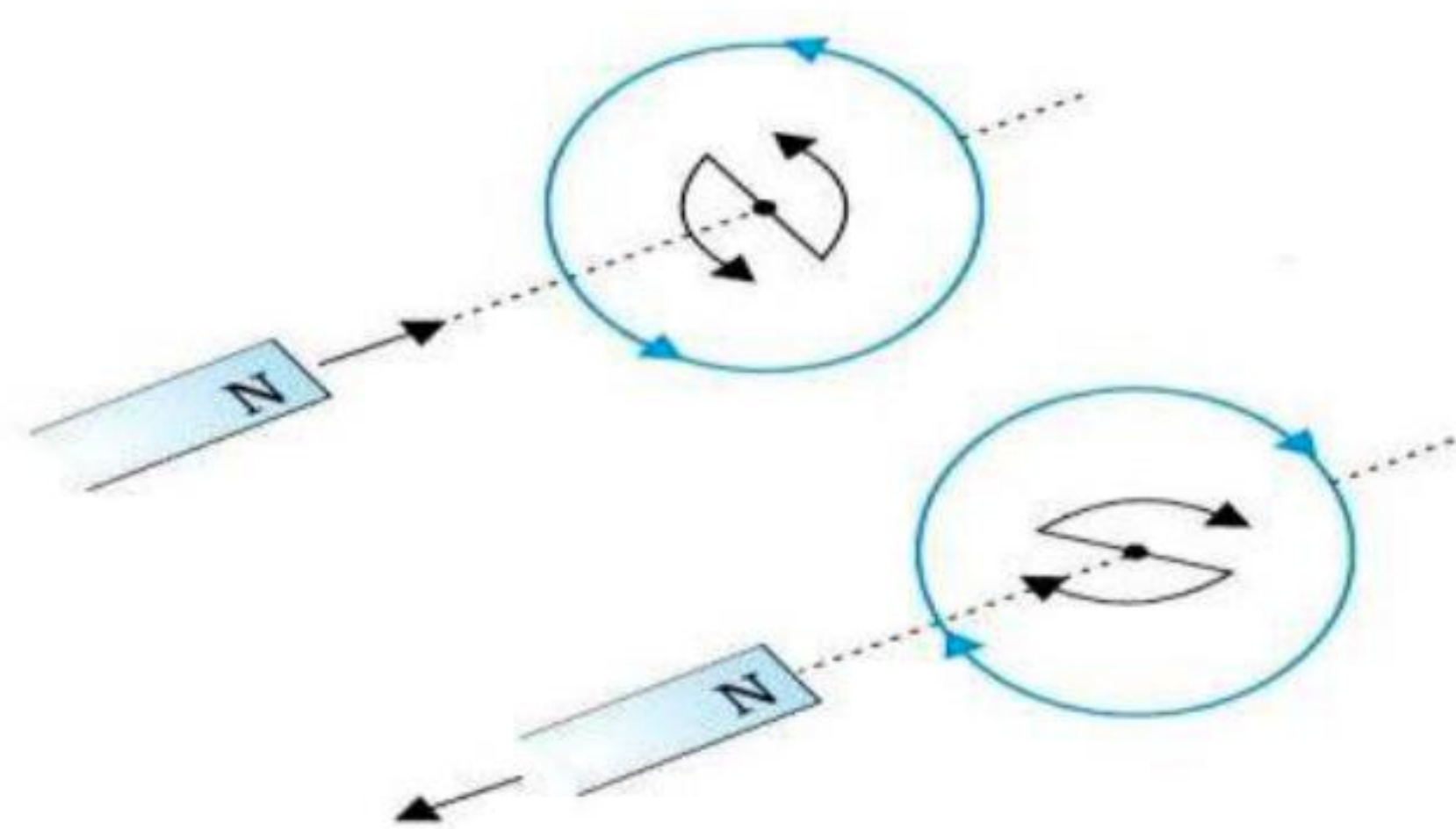

(Also accept any other example appropriate)

$$|\varepsilon| = L \frac{di}{dt}$$

$$|\varepsilon| = 5 \times 10^{-3} \times \frac{(4 - 1)}{30 \times 10^{-3}} V = 0.5V$$

OR

Difference and Explanation	1½
Formula	½
Calculation and result	1

In magnetism, Gauss's law states: $\oint \vec{B} \cdot d\vec{s} = 0$

In electrostatics, Gauss's law states: $\oint \vec{E} \cdot d\vec{s} = \frac{q}{\varepsilon_0}$

Reason: Isolated magnetic poles do not exist

$$B = \frac{\mu_0}{4\pi} \left(\frac{m}{R^3} \right) = 10^{-7} \left(\frac{m}{R^3} \right)$$

$$m = \frac{0.4 \times 10^{-4} \times (6400 \times 10^3)^3}{10^{-7}}$$

$$= 1.1 \times 10^{23} \text{ Am}^2$$

Set-1, Q16
Set-2, Q18
Set-3, Q12

Production	½
Source of Energy	½
Schematic Sketch	½
Directions of \vec{E} and \vec{B} :	½+½
Relation	½

Production: Electromagnetic waves are produced by 'accelerated Charges'

The battery/ Electric field that accelerates the charge carriers is the source of energy of em waves.

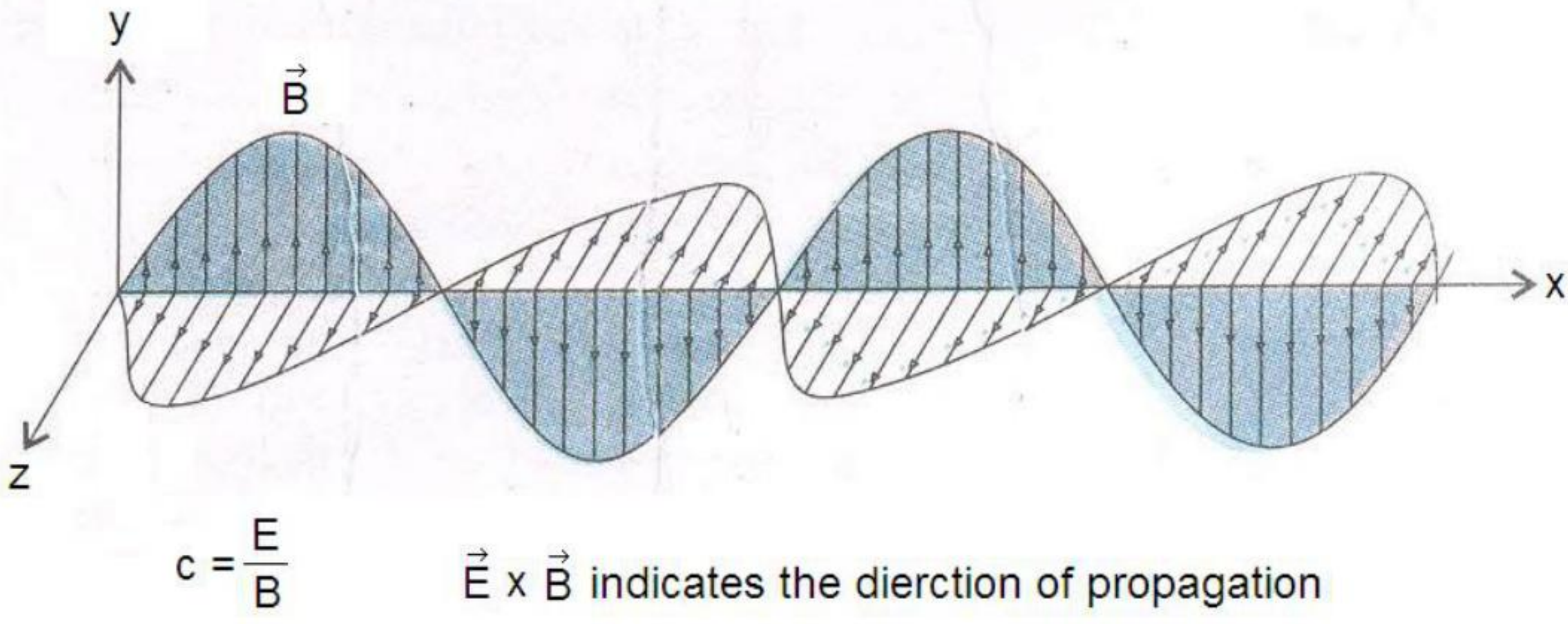

	<p>Schematic sketch/ diagram</p>  <p>Directions of \vec{E} Along y axis/ Along z axis</p> <p>Directions of B Along z axis/ Along y axis</p> <p>Relation: $c = \frac{E}{B}$</p>	<p>1/2</p> <p>1/2</p> <p>1/2</p> <p>1/2</p>	<p>3</p>								
<p>Set-1, Q17 Set-2, Q19 Set-3, Q13</p>	<table border="1" data-bbox="373 1181 1619 1347"> <tr> <td>Writing the formula: $N = N_0 e^{-\lambda t}$</td> <td>1/2</td> </tr> <tr> <td>Obtaining the Relation</td> <td>1</td> </tr> <tr> <td>Numerical</td> <td>1 1/2</td> </tr> </table> <p>We have $N = N_0 e^{-\lambda t}$</p> <p>When $t = T_{1/2}$ (the half life), we have $N = \frac{N_0}{2}$</p> $\therefore \frac{N_0}{2} = N_0 e^{-\lambda T_{1/2}}$ <p>This gives</p> $T_{1/2} = \frac{\ln 2}{\lambda}$ <p>Numerical: We have $\frac{N}{N_0} = 6.25\% = \frac{6.25}{100} = \frac{1}{16} = \left(\frac{1}{2}\right)^4$</p> <p>$\therefore$ Required time = 4 \times (half life)</p> <p>= 4 \times 100 days</p> <p>= 400 days</p>	Writing the formula: $N = N_0 e^{-\lambda t}$	1/2	Obtaining the Relation	1	Numerical	1 1/2	<p>1/2</p> <p>1/2</p> <p>1/2</p> <p>1/2</p> <p>1/2</p> <p>1/2</p>	<p>3</p>		
Writing the formula: $N = N_0 e^{-\lambda t}$	1/2										
Obtaining the Relation	1										
Numerical	1 1/2										
<p>Set-1, Q18 Set-2, Q11 Set-3, Q14.</p>	<table border="1" data-bbox="373 2119 1591 2338"> <tr> <td>Two important considerations</td> <td>1/2+1/2</td> </tr> <tr> <td>Circuit Diagram</td> <td>1/2</td> </tr> <tr> <td>Principle</td> <td>1/2</td> </tr> <tr> <td>Working</td> <td>1</td> </tr> </table> <p><u>Two important considerations</u></p> <p>Heavy doping of both p and n sides</p> <p>Appropriate 'break down voltage' under reverse bias</p>	Two important considerations	1/2+1/2	Circuit Diagram	1/2	Principle	1/2	Working	1	<p>1/2</p> <p>1/2</p>	<p>3</p>
Two important considerations	1/2+1/2										
Circuit Diagram	1/2										
Principle	1/2										
Working	1										

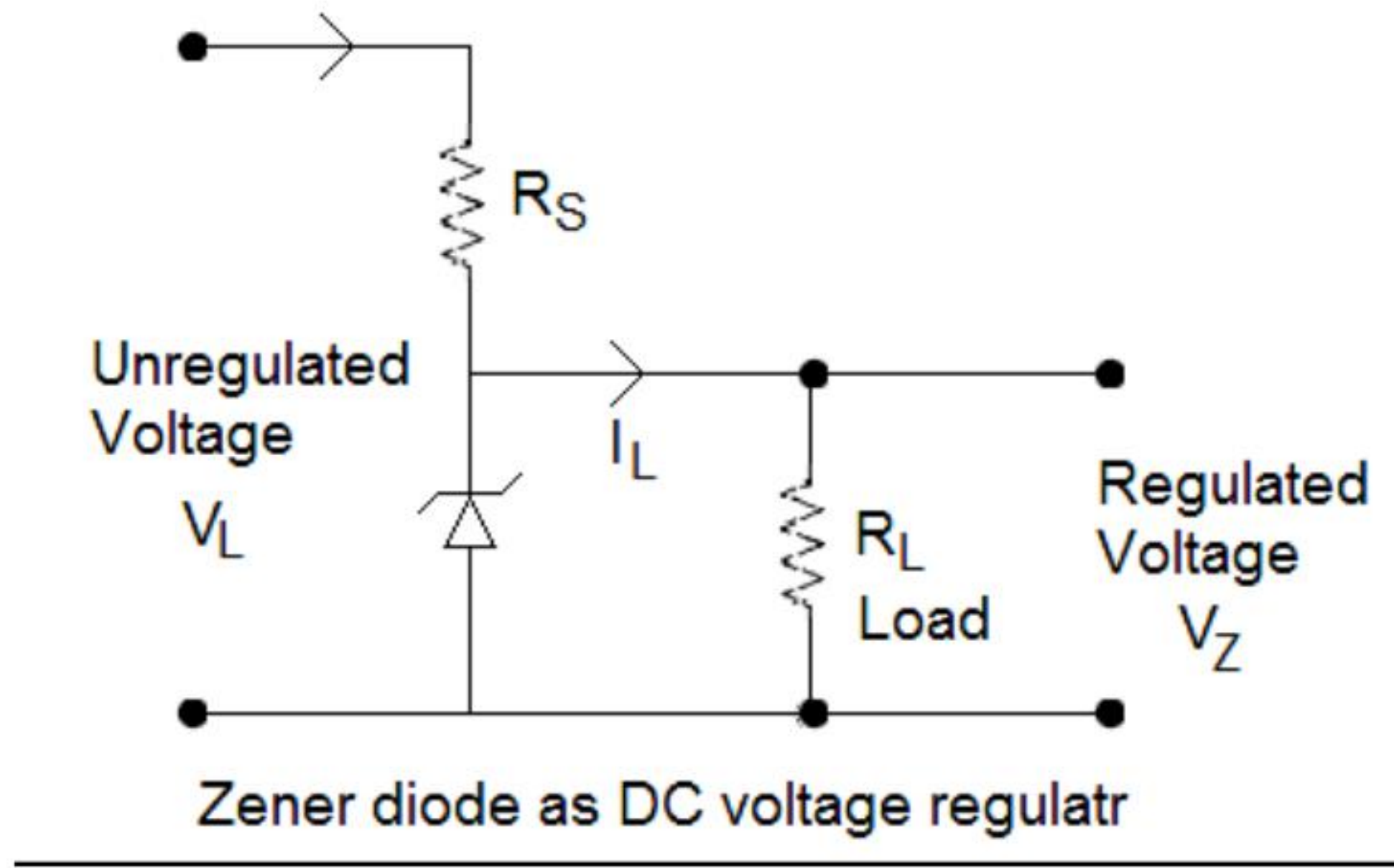
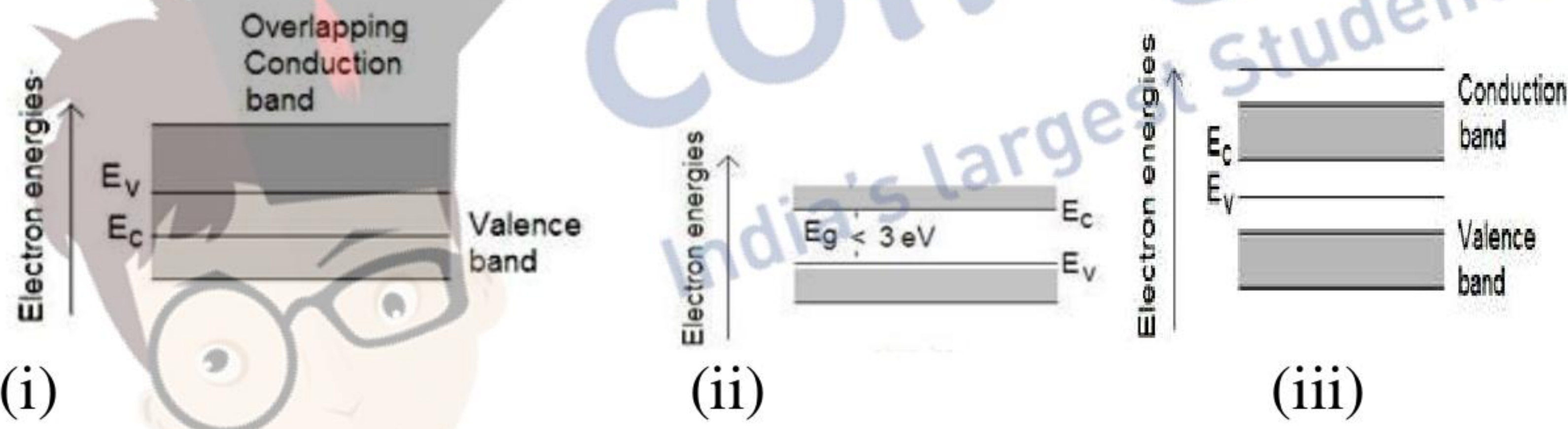

	<p>(Award 1/2 mark even if the student writes only one of these)</p> <p><u>Circuit diagram</u></p>  <p style="text-align: center;">Zener diode as DC voltage regulator</p> <p><u>Principle:</u> Even small reverse bias voltage (5V) can produce a very high electric field because the depletion region is very thin</p> <p><u>Working -</u> The unregulated DC voltage is connected to the Zener diode through a series resistance R_S such that the Zener diode is reverse biased. In break down region, the Zener voltage remains constant even though the current through Zener diode changes. This helps to regulate the output voltage</p>	<p>1/2</p> <p>1/2</p> <p>1</p>	<p>3</p>				
<p>Set-1, Q19 Set-2, Q12 Set-3, Q21</p>	<table border="1" style="width: 100%;"> <tr> <td style="width: 60%;">Energy band diagrams</td> <td style="width: 40%;">1 1/2</td> </tr> <tr> <td>Effect of change of temperature</td> <td>1 1/2</td> </tr> </table>  <p>(i) In conductor, collision become more frequent at higher temperature lowering conductivity.</p> <p>(ii) In semiconductors, more electron hole pairs become available at higher temperature so conductivity increases.</p> <p>(iii) In insulators, the band gap is unsurpassable for ordinary temperature rise. Hence there is practically no change in their behavior.</p>	Energy band diagrams	1 1/2	Effect of change of temperature	1 1/2	<p>1/2+1/2+1/2</p> <p>1/2</p> <p>1/2</p> <p>1/2</p>	<p>3</p>
Energy band diagrams	1 1/2						
Effect of change of temperature	1 1/2						
<p>Set-1, Q20 Set-2, Q13 Set-3, Q22</p>	<table border="1" style="width: 100%;"> <tr> <td style="width: 60%;">(a) Three Basic units & their function</td> <td style="width: 40%;">1/2+1/2+1/2</td> </tr> <tr> <td>(b) Three applications of Internet</td> <td>1/2+1/2+1/2</td> </tr> </table> <p><u>Three Basic units</u> Transmitter: Processing & transmission of message signal</p>	(a) Three Basic units & their function	1/2+1/2+1/2	(b) Three applications of Internet	1/2+1/2+1/2	<p>1/2</p>	
(a) Three Basic units & their function	1/2+1/2+1/2						
(b) Three applications of Internet	1/2+1/2+1/2						

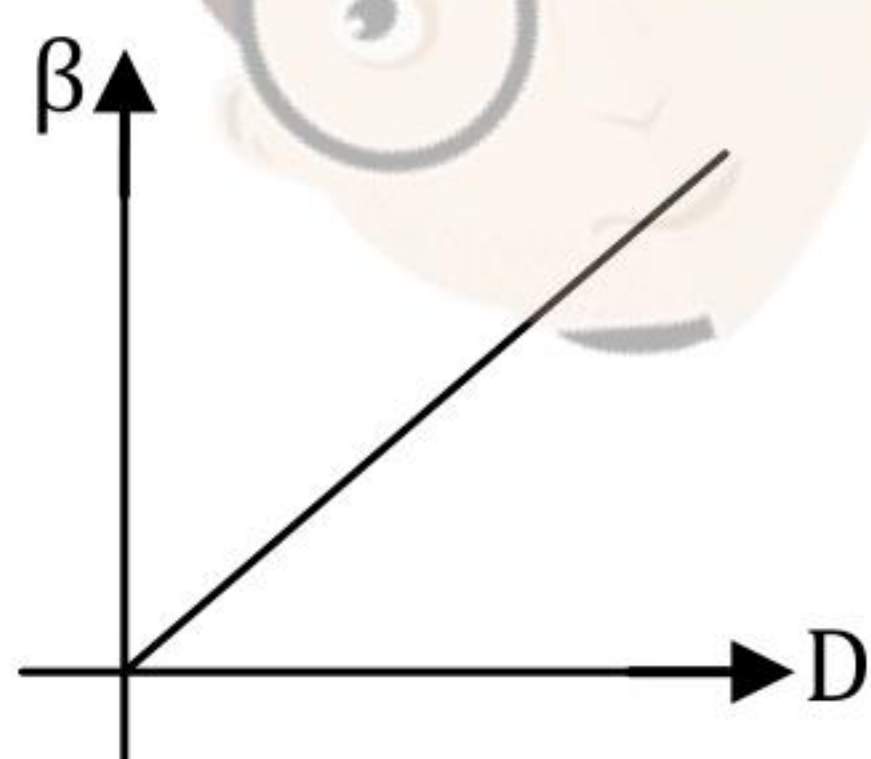

	<p>Communication channel: The link for propagating the signal from transmitter to receiver.</p> <p>Receiver: Extracting the message signal from the signal received by it.</p> <p>Three applications of internet: (i) internet surfing (ii) E-mails (iii) E-banking (iv) E-shopping (v) E-booking (e-ticketing) (vi) Social networking + additional applications(Any three)</p>	<p>1/2</p> <p>1/2</p> <p>1/2 + 1/2 + 1/2</p>	<p>3</p>										
<p>Set-1, Q21 Set-2, Q14 Set-3, Q19</p>	<table border="1"> <tr> <td>(a) Conditions</td> <td>1/2</td> </tr> <tr> <td>(b) Formula</td> <td>1/2</td> </tr> <tr> <td>Graph</td> <td>1</td> </tr> <tr> <td>Effect on Fringe Width</td> <td>1/2</td> </tr> <tr> <td>Information from scope</td> <td>1/2</td> </tr> </table>	(a) Conditions	1/2	(b) Formula	1/2	Graph	1	Effect on Fringe Width	1/2	Information from scope	1/2		
(a) Conditions	1/2												
(b) Formula	1/2												
Graph	1												
Effect on Fringe Width	1/2												
Information from scope	1/2												
	<p><u>Conditions:</u> The two superposing sources must be coherent and obtained from the same source. (Also award this 1/2 mark is the student just writes that two sources must have the same frequency)</p> <p><u>Formula:</u> $\beta = \frac{\lambda D}{d}$</p>  <p>Slope = $\frac{\lambda}{d}$ or $\lambda = \text{slope} \times d$</p> <p>Effect: the fringe width would increase (Alternatively : $\beta \propto \frac{1}{d}$)</p>	<p>1/2</p> <p>1/2</p> <p>1</p> <p>1/2</p> <p>1/2</p>	<p>3</p>										



Set-1, Q22 Set-2, Q15 Set-3, Q20	<table border="1"> <tr> <td>Graph</td> <td>1</td> </tr> <tr> <td>(a) Sharper resonance (Case + reason)</td> <td>1/2+1/2</td> </tr> <tr> <td>(b) More power Dissipation case</td> <td>1/2</td> </tr> <tr> <td>Reason</td> <td>1/2</td> </tr> </table> <p>(a) Sharper for $R = R_2$ Sharpness of resonance = $\frac{\omega_0 L}{R} \propto \frac{1}{R}$</p> <p>(b) More power dissipation for $R = R_2$ At Resonance, power dissipation = $\frac{V^2}{R} \propto \frac{1}{R}$ (for same V)</p>	Graph	1	(a) Sharper resonance (Case + reason)	1/2+1/2	(b) More power Dissipation case	1/2	Reason	1/2	1	1/2 1/2 1/2 1/2	3
Graph	1											
(a) Sharper resonance (Case + reason)	1/2+1/2											
(b) More power Dissipation case	1/2											
Reason	1/2											

Section D

Set-1, Q23 Set-2, Q23 Set-3, Q23	<table border="1"> <tr> <td>(a) Values</td> <td>1+1</td> </tr> <tr> <td>(b) Reason</td> <td>1</td> </tr> <tr> <td>(c) Explanation</td> <td>1</td> </tr> </table> <p>(a) Presence of mind, careful, helpful/Awareness etc. (any two).</p> <p>(b) The two feet of the bird, sitting on the live wire, are at the same potential. Hence, no current passes through its body.</p> <p>The potential difference between the earth and the live wire when somebody touches a live wire, standing on the ground can result in a passage of current, so a fatal shock.</p> <p>(c) Transmitting the power at a very high voltage is equivalent to lowering the current to a very low level, so Transmission losses ($= i^2 R$) are minimized.</p>	(a) Values	1+1	(b) Reason	1	(c) Explanation	1	1/2+1/2	1/2 1 1/2 1/2	4
(a) Values	1+1									
(b) Reason	1									
(c) Explanation	1									

Section E

Set-1, Q24 Set-2, Q26 Set-3, Q25	<table border="1"> <tr> <td>Obtaining the expression for magnetic field</td> <td>2</td> </tr> <tr> <td>Diagram & Force (magnitude & direction)</td> <td>1/2+1/2+1/2</td> </tr> <tr> <td>Change in nature of force</td> <td>1/2</td> </tr> <tr> <td>Definition of SI unit of current</td> <td>1</td> </tr> </table>	Obtaining the expression for magnetic field	2	Diagram & Force (magnitude & direction)	1/2+1/2+1/2	Change in nature of force	1/2	Definition of SI unit of current	1			
Obtaining the expression for magnetic field	2											
Diagram & Force (magnitude & direction)	1/2+1/2+1/2											
Change in nature of force	1/2											
Definition of SI unit of current	1											



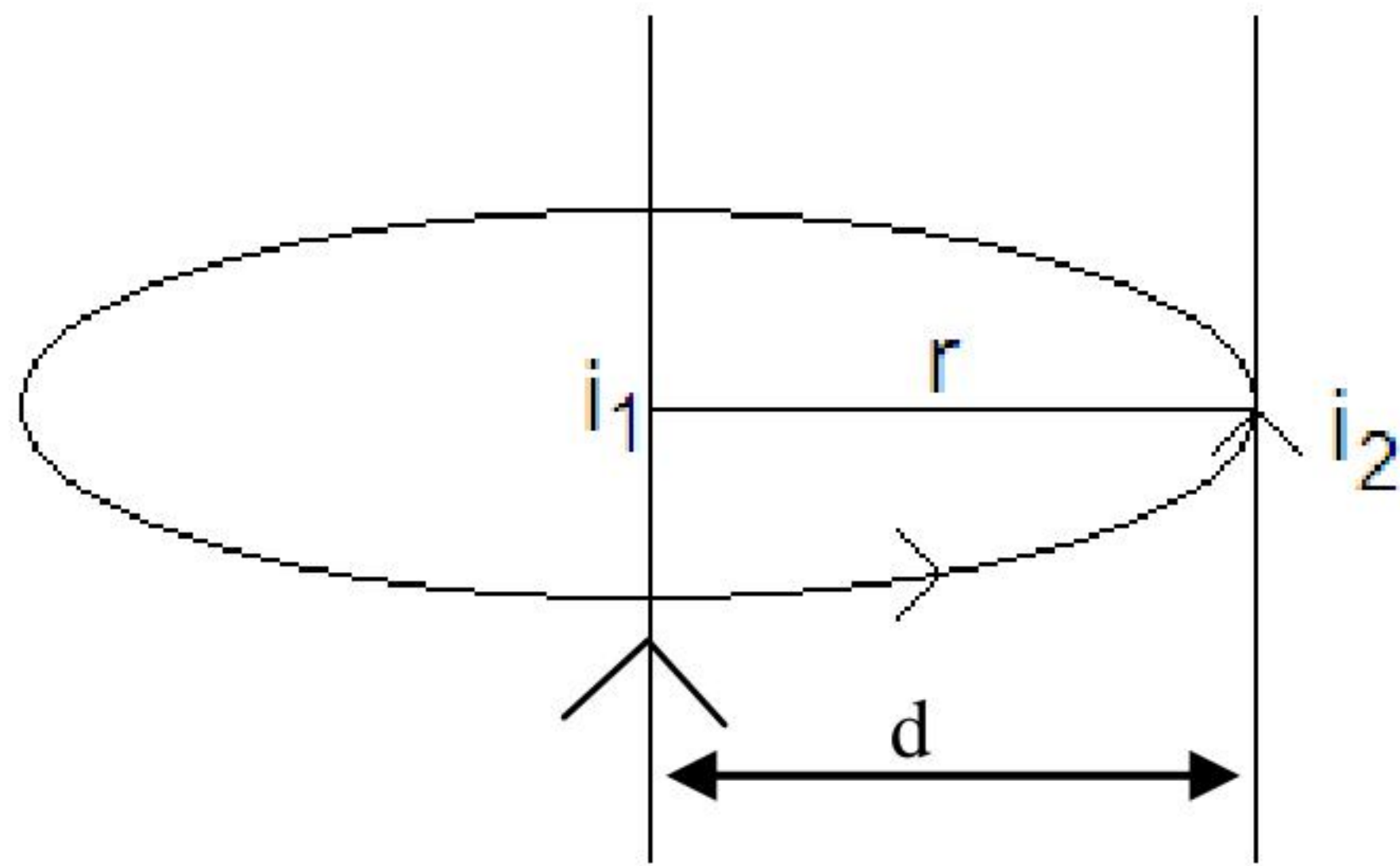

Consider a (circle) Amperian loop of radius 'd' centered at the wire 'i' and having its plane perpendicular to the wire.

$$\oint \vec{B} \cdot d\vec{l} = \mu_0 i_1$$

By symmetry B has the same magnitude at every point on the contour, and is tangential. If we go along the contour anticlockwise, \vec{B} is along $d\vec{l}$ and $\vec{B} \cdot d\vec{l} = B dl$

$$B \oint dl = \mu_0 i_1, \quad B 2\pi d = \mu_0 i_1$$

$$\therefore B_i = \frac{\mu_0 i_1}{2\pi d}$$

Now $\vec{F}_{2i} = i_2 \vec{l}_2 \times \vec{B}_i$ \therefore

$$F_{2i} = i_2 l_2 B = \frac{\mu_0 i_1 i_2 l_2}{2\pi d} \text{ (substituting the value of B)}$$

$$\therefore \frac{\text{Force}}{\text{Length}} = \frac{\mu_0 i_1 i_2}{2\pi d}$$

\vec{F} is directed towards left so wire '2' is attracted by the force of magnetic field of wire '1', acting on it.

If I, reverses direction, \vec{F} is directed toward right i.e. wire 1 repels wire 2`.

$$\text{If } i_1 = i_2 = 1 \text{ amp and } d = 1\text{m then } \frac{F}{l} = \frac{\mu_0}{2\pi} \text{ N/m} \\ = 2 \times 10^{-7} \text{ N/m}$$

Definition of SI unit of current

Or

Diagram	1/2
Principle	1/2
Deriving the relation	2
Two assumption	1/2+1/2
Two causes of energy loss	1/2+1/2

1/2

1/2

1/2

1/2

1/2

1/2

1/2

1

5



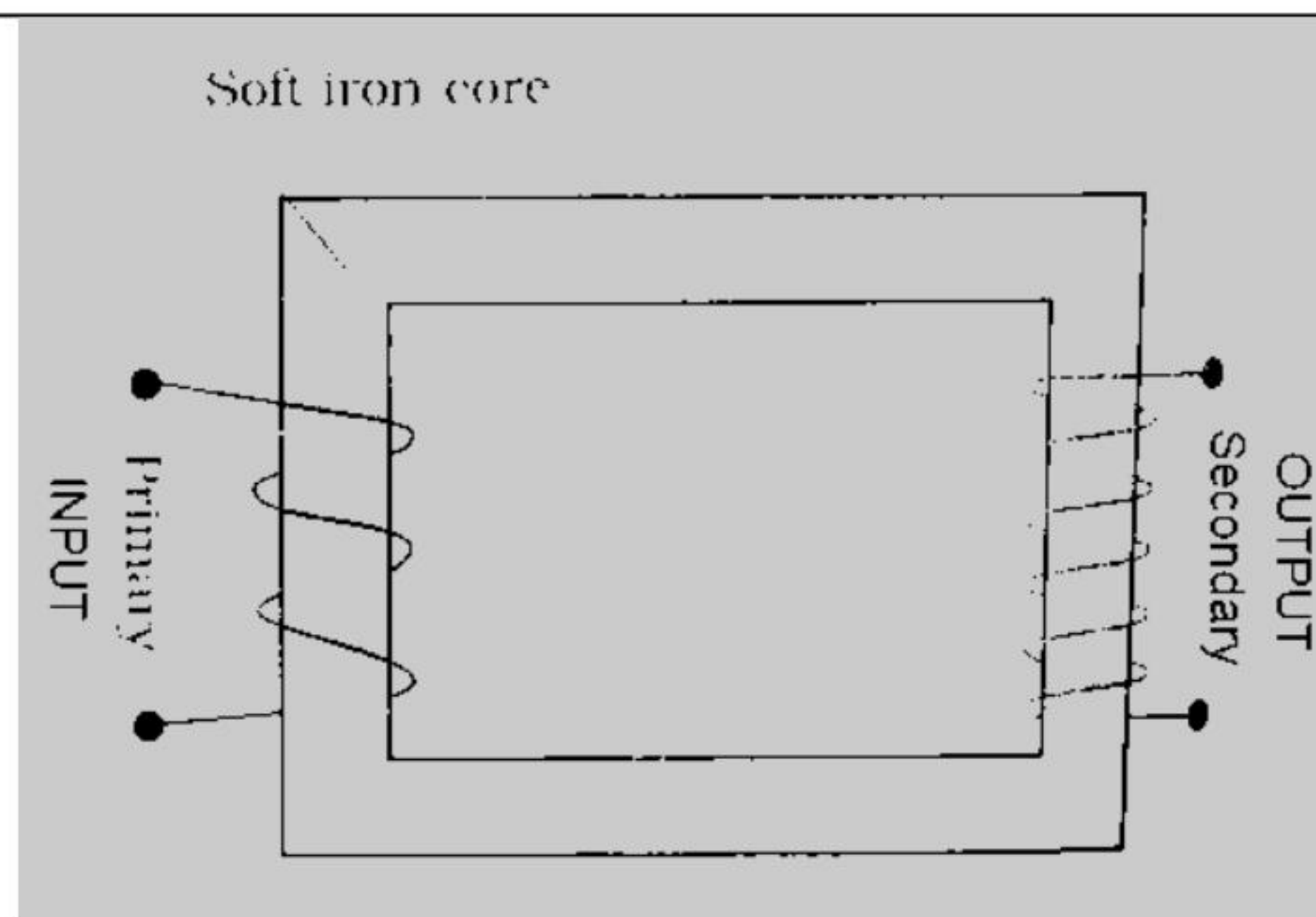

Principle : A transformer is based on the phenomena of mutual induction, i.e., whenever the current flowing in the primary coil changes, an emf is induced in the secondary coil.

Let $\frac{d\phi}{dt}$ be the rate of change of magnetic flux per turn of each coil

\therefore emf induced in the primary

$$E_p = N_p \frac{d\phi}{dt}$$

emf in secondary

$$E_s = N_s \frac{d\phi}{dt}$$

N_p & N_s are the no. of turns in primary & secondary coils respectively.

$$\therefore \frac{E_s}{E_p} = \frac{N_s}{N_p}$$

Assumptions

- (i) The flux linked ($=\phi$) with each turn of primary and secondary coils, has the same value.
- (ii) Induced EMF in primary = applied A/c, Voltage across it.
- (iii) The primary resistance and current are small.
- (iv) There is no leakage of magnetic flux. The same magnetic flux links both, primary & secondary coils.
- (v) The secondary current is small.

(Any two of the above assumptions)

Energy losses are due to

- (i) Flux leakage/ Eddy current/ Humming sound/ Heat loss (I^2R)
- (ii) Hysteresis loss

(Any Two)

Set-1, Q25
Set-2, Q24
Set-3, Q26

(a) Two rules & Justification	1+1
(b) Deriving the expression	2 +1

(a) The junction rule: When currents are steady, the sum of currents entering a



junction is equal to the sum to currents leaving the junction. This rule is based on the law of conservation of charge.

1/2

(ii) The loop rule: The algebraic sum of the changes in potentials in any loop is equal to the algebraic sum of emfs.

1/2

$$\sum iR = \sum E_i$$

The basis of this rule is the law of conservation of energy for electric circuits.

1/2

2

(b)

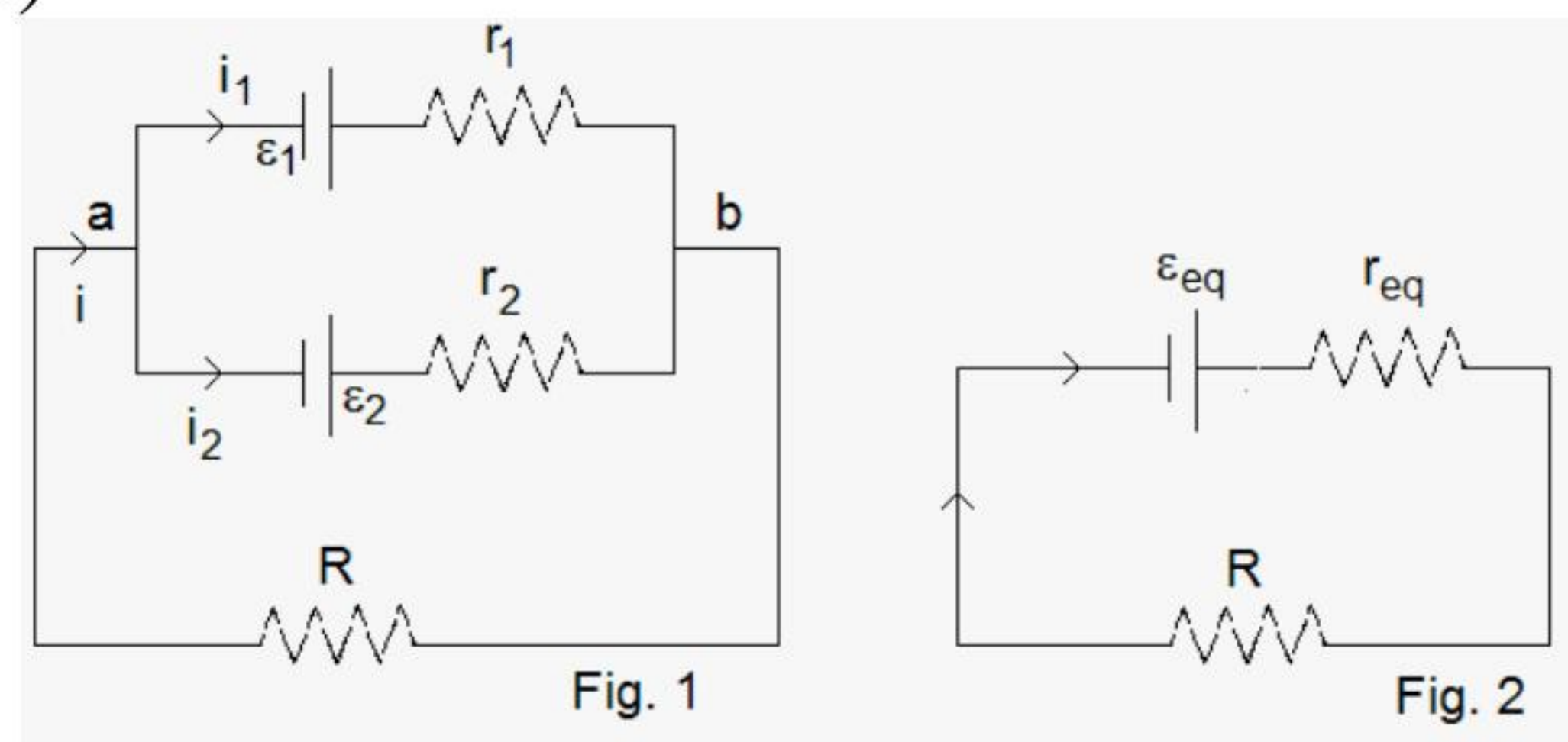

At junction a $i = i_1 + i_2$

..... (i)

For the two loops involving R and r_1 and R & r_2

$$iR + i_1 r_1 = \varepsilon_1$$

..... (ii)

$$iR + i_2 r_2 = \varepsilon_2$$

..... (iii)

solving (i) , (ii) and (iii) simultaneously we get

$$iR + \frac{r_1 r_2}{r_1 + r_2} = \frac{\varepsilon_1 r_2 + \varepsilon_2 r_1}{r_1 + r_2}$$

..... (iv)

Fig, (ii) shows the equivalent circuit, giving the equation

$$iR + i r_{eq} = \varepsilon_{eq}$$

..... (v)

Comparing equation (iv) and (v) we have

$$r_{eq} = \frac{r_1 r_2}{r_1 + r_2}; \varepsilon_{eq} = \frac{\varepsilon_1 r_2 + \varepsilon_2 r_1}{r_1 + r_2}$$

1/2+1/2

3

Or

a) Two reasons	1+1
b) Finding the Net Electric Field	3

5

(a)



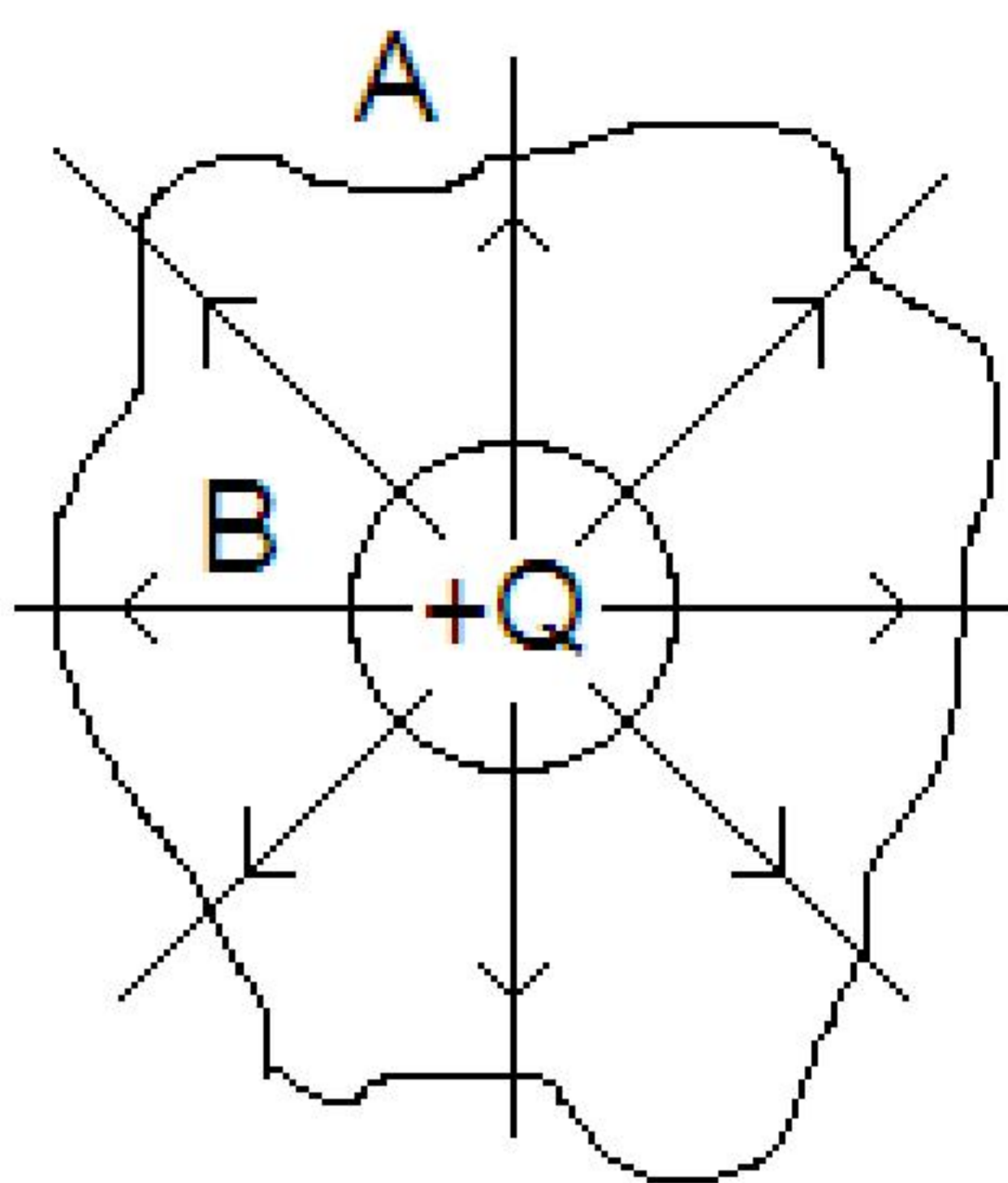

The figure shows two surfaces A and B of different shapes and sizes enclosing a given charge +Q.

(i) For a given charge, the number of field lines, emanating from it, depends only on the net charge enclosed and not on the shape or size of surface enclosing it.

(ii) By Gauss's law of electrostatics, the outward flux of the electric field is the $\oint \vec{E} \cdot d\vec{s} = \frac{Q}{\epsilon_0}$. This is same for both the surfaces, since both enclose the same charge (Q).

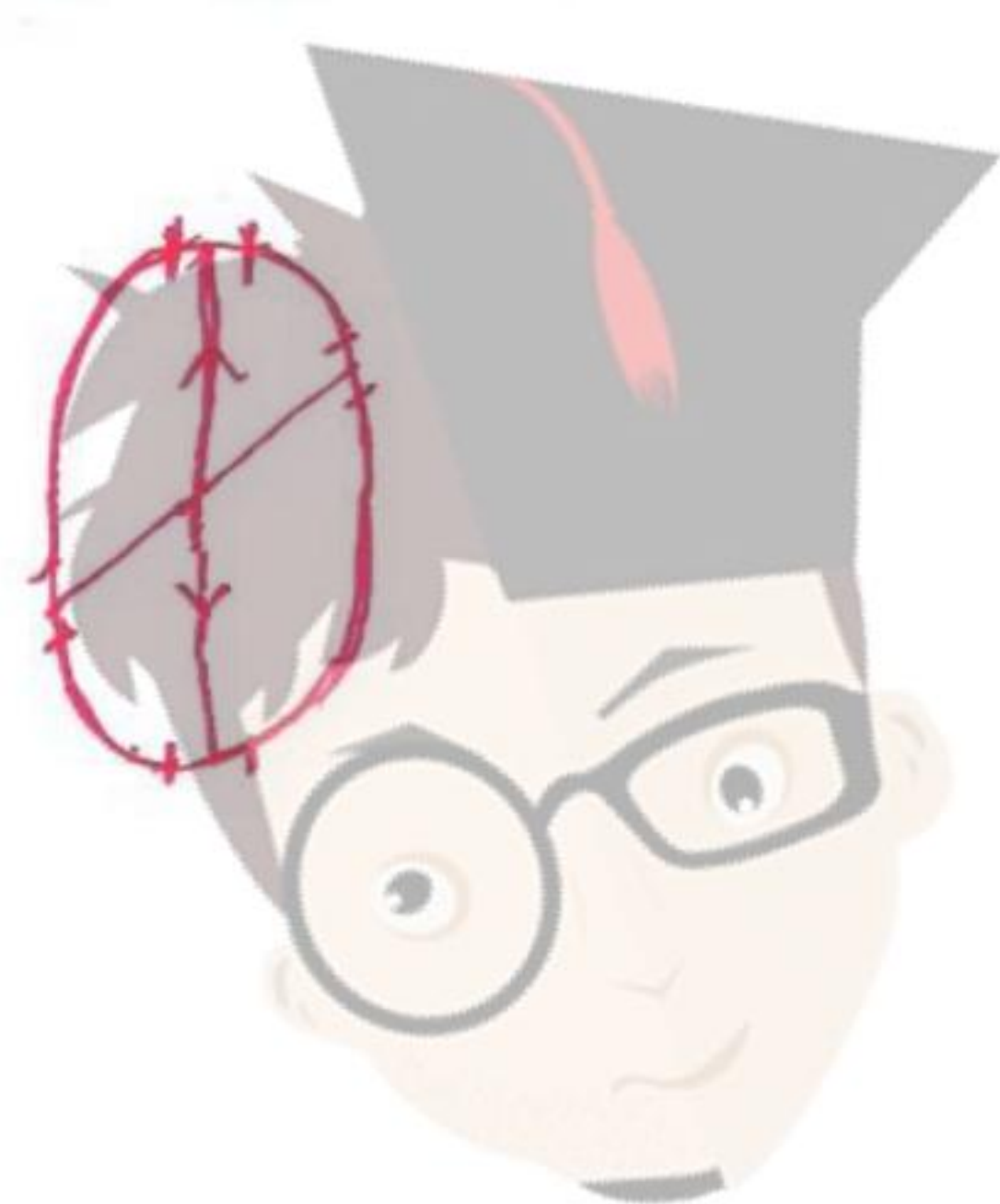

(b) Field of the centre of loop 1, due to its own charge = zero
(This is because each element of the loop, has a corresponding symmetrical element which produces an equal and opposite fields at the centre)

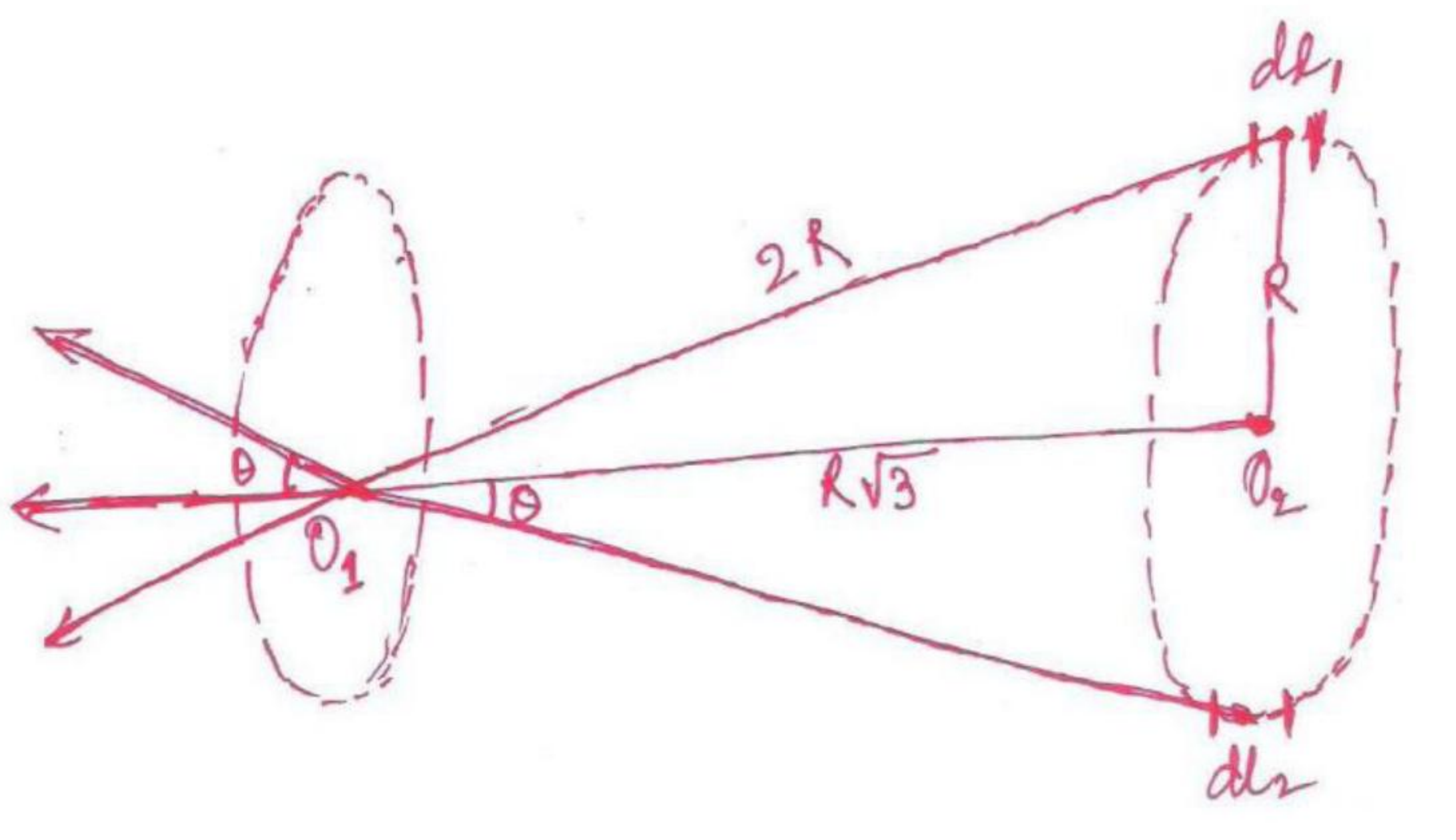

For finding the field at O_1 , due to coil 2

Total field at O_1 due to two elements dl_1 and dl_2 of coil 2.

= sum of their horizontal components

$$= \frac{1}{4\pi\epsilon_0} \cdot \frac{2\lambda dl}{(2R)^2} \cos \theta = \frac{1}{4\pi\epsilon_0} \cdot \frac{2\lambda dl}{(2R)^2} \cdot \frac{R\sqrt{3}}{R}$$

$$\frac{1}{4\pi\epsilon_0} \cdot \frac{2\lambda dl}{(2R)^2} \cdot \frac{\sqrt{3}}{2}$$

$$\therefore \text{Total field at } O_1 = \frac{\sqrt{3}}{4\pi\epsilon_0} \cdot \frac{\lambda}{4R^2} \cdot (\sum dl)_{\text{over half the loop}}$$

$$= \frac{\sqrt{3}}{4\pi\epsilon_0} \cdot \frac{\lambda}{4R^2} \cdot \pi R$$

$$= \frac{1}{4\pi\epsilon_0} \cdot \frac{\sqrt{3}\pi\lambda}{4R} = \frac{\sqrt{3}\pi\lambda}{16\epsilon_0 R}$$

This field, as seen from above, is directed along the line $O_2 O_1$.

$$\therefore \text{Total field at } O_1 \text{ due to both the coils } O_1 = \frac{1}{4\pi\epsilon_0} \left[\frac{(\pi\sqrt{3})\lambda}{4R} \right] \text{ (along } O_2 O_1)$$

Alternatively

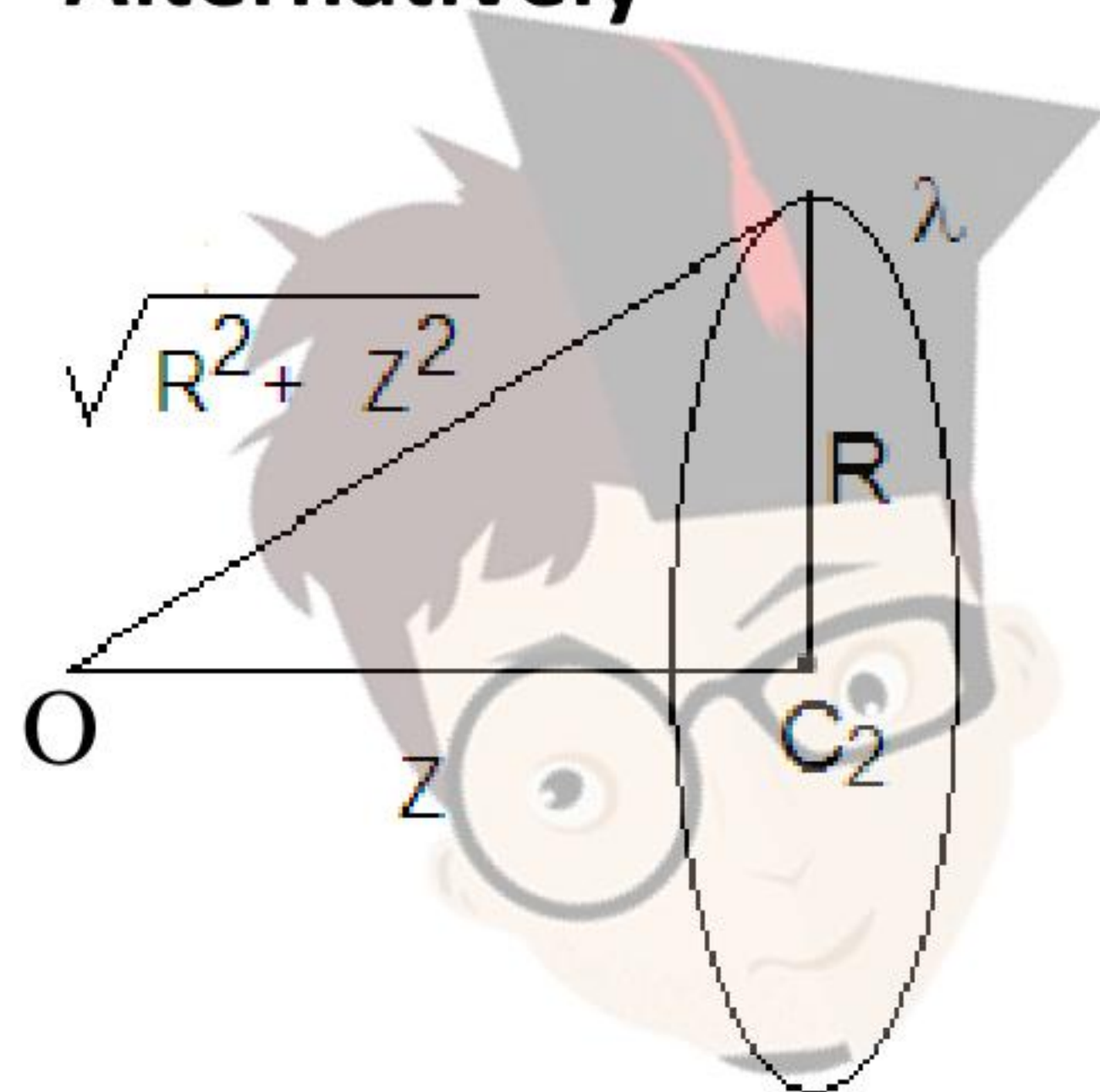

The field at an axial point of a circular loop of radius R and linear charge density λ , is given by

$$\vec{E} = \frac{\lambda R}{2\epsilon_0} \frac{Z}{(R^2 + Z^2)^{3/2}} \hat{z}$$

The field at C

$$\text{is } \vec{E} = \vec{E}_1 + \vec{E}_2 = 0 + \frac{\lambda R}{2\epsilon_0} \frac{R\sqrt{3}}{(2R)^3} \text{ towards left}$$

$$= \frac{\lambda\sqrt{3}}{16\epsilon_0 R} \text{ towards left.}$$

$$(\vec{E}_1 = 0 \text{ since } z = 0)$$

1/2

1/2

1/2

3

5

1

1/2

1/2

1/2

1/2



(\vec{E}_2 is towards left because λ is (+)ve)

Set-1, Q26
Set-2, Q25
Set-3, Q24

(a) Diagram	1
Proving $\frac{v_2}{v_1} = \frac{\sin i}{\sin r}$	2
(b) (i) Reason	1
(ii) Brewster law	1

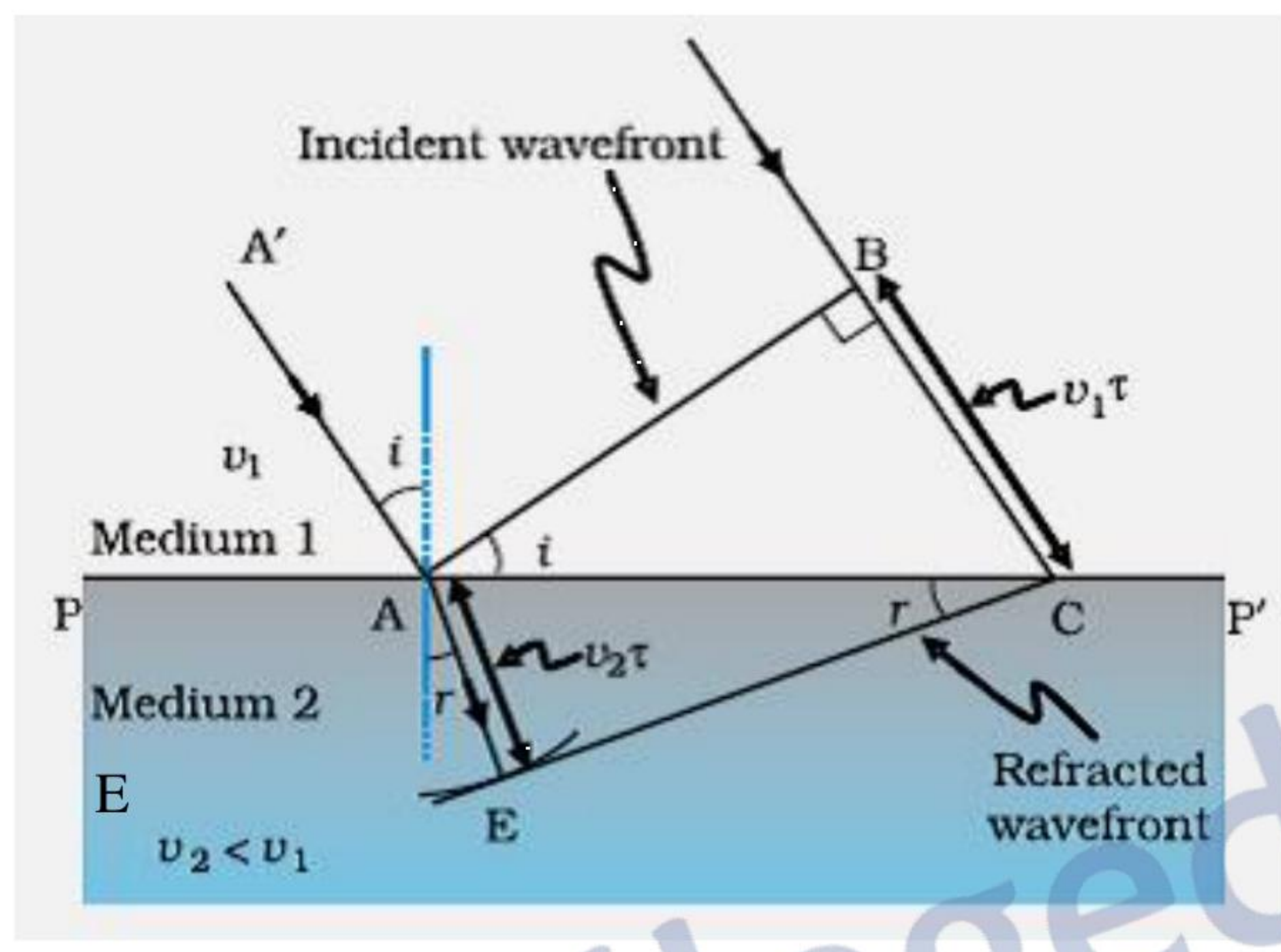

(a) We consider refraction of a plane wave at a rarer medium, i.e., $v_1 > v_2$
The angle of refraction will be greater than angle of incidence.

$$n_1 \sin i = n_2 \sin r$$

$$\sin i_c = \frac{n_2}{n_1}$$

$$\therefore \frac{n_2}{n_1} = \frac{\sin i}{\sin r}$$

But $\frac{n_2}{n_1} = \text{ratio of speed of lights}$

$$\therefore \frac{v_2}{v_1} = \frac{\sin i}{\sin r}$$

(i) It absorbs the electric vectors of the incident light along the direction of alignment of its molecules and only lets the perpendicular electric vectors to go through.

(ii) At the Brewster's angle of incidence ($\angle i_B$)

$$\angle i_B + \angle r_B = \frac{\pi}{2}$$

1

1/2

1/2

2

1/2

1

1/2



$$\therefore \mu = \frac{\sin i_B}{\sin r_B} = \tan i_B \left(\frac{1}{2}\right)$$

This is known as Brewsters's Law.

Or

Equivalent Focal Length	2½
Obtaining the condition	1
Nature of combination + Ray diagram	1
Nature of image	½

The image distance V_1 for the surface is the object distance for the second surface, Radius of curvature of the first surface is R that of the second surface is $-R$

$$\frac{\mu_1}{V_1} - \frac{1}{u} = \frac{\mu_1 - 1}{R} \quad (\text{Refraction at first surface})$$

$$\frac{\mu_2}{V} - \frac{\mu_1}{V_1} = \frac{\mu_2 - \mu_1}{-R} \quad (\text{Refraction at second surface})$$

$$\therefore \frac{\mu_2}{V} - \frac{1}{u} = \frac{2\mu_1 - \mu_2 - 1}{R}$$

$$\text{At } u = -\infty \quad V = f$$

$$\therefore f = \frac{\mu_2 R}{2\mu_1 - \mu_2 - 1}$$

(b) For the combination to be diverging

$$f < 0$$

This requires $\mu_1 < \left(\frac{\mu_2 + 1}{2}\right)$

(c) for $\mu_1 > \frac{\mu_2 + 1}{2}$, $f > 0$

So the combination acts as a converging lens

(of focal length $f = \frac{\mu_2 R}{2\mu_1 - \mu_2 - 1}$).

½

½

2

½

5

½

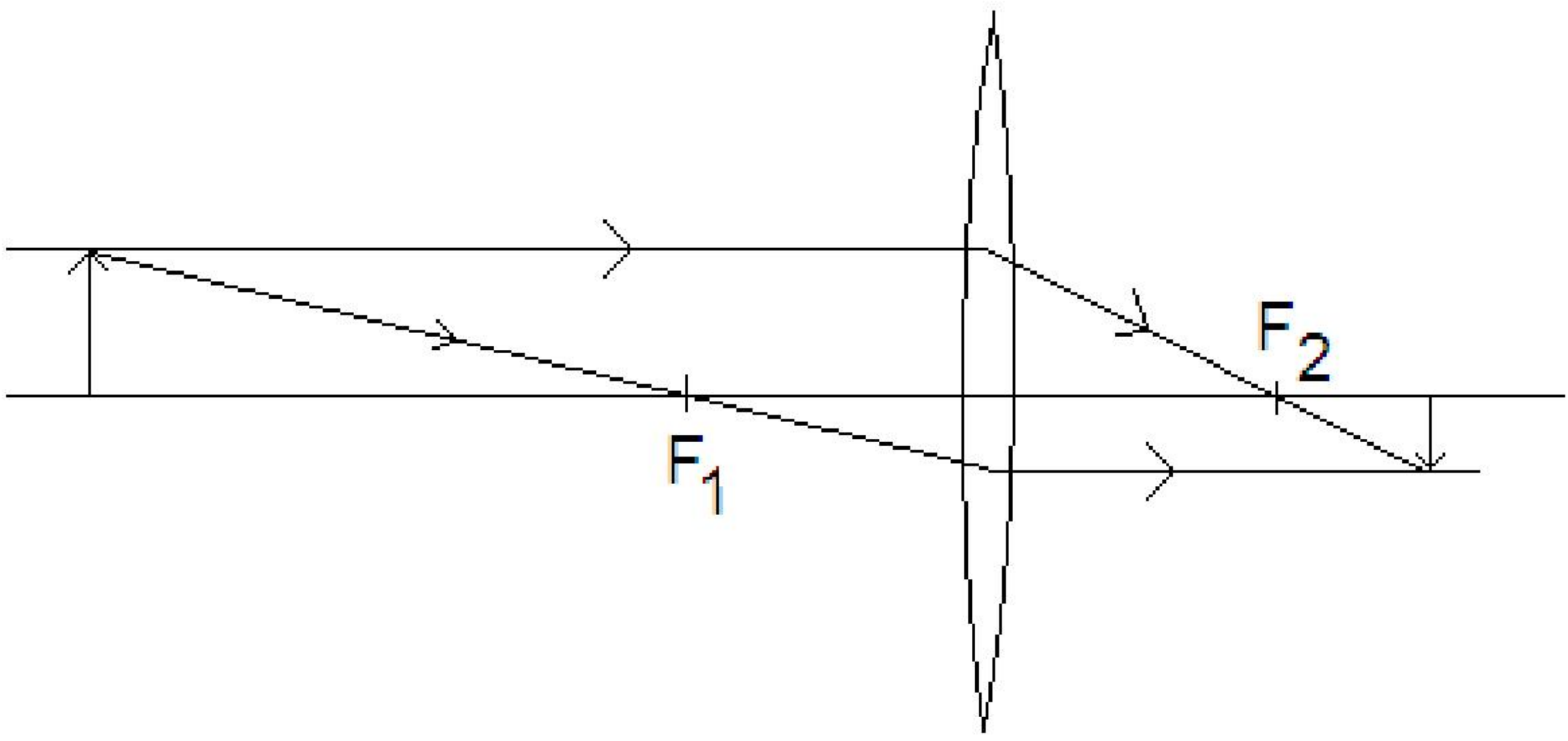

	 <p>The image formed is a real image.</p>	$\frac{1}{2}$	5
--	---	---------------	---



collegedunia.com
India's largest Student Review Platform

