



Practice, Learn and Achieve
Your Goal with Prepp

IBPS CLERK Exam

Prelims Answer Key

Simplifying
Government Exams

 SSC CHSL	 IAS EXAM	 RRB NTPC	 NTSE	 CDS
 SSC CGL	 CBSE UGC NET	 IBPS PO	 NDA	
 SBI PO	 IBPS CLERK	 AFCAT	 SSC JE	 CTET
 CSIR UGC NET	 CAPF	 IBPS RRB		

Solutions

1. Ans. C.

$$98 = 97 + 1^3$$

$$90 = 98 - 2^3$$

$$117 = 90 + 3^3$$

$$? = 117 - 4^3, \text{ i.e. } ? = 53$$

$$178 = 53 + 5^3$$

2. Ans. A.

$$11 = 8 + 3^1$$

$$20 = 11 + 3^2$$

$$47 = 20 + 3^3$$

$$? = 47 + 3^4, \text{ i.e. } ? = 128$$

$$371 = 128 + 3^5$$

3. Ans. B.

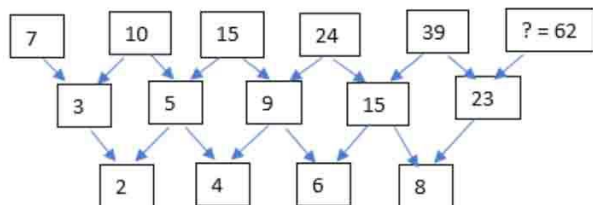

4. Ans. C.

$$14 = 5 \times 3 - 1$$

$$41 = 14 \times 3 - 1$$

$$122 = 41 \times 3 - 1$$

$$? = 122 \times 3 - 1, \text{ i.e. } ? = 365$$

$$1094 = 365 \times 3 - 1$$

5. Ans. D.

$$18 \times 0.5 = 9$$

$$9 \times 1 = 9$$

$$9 \times 1.5 = 13.5$$

$$13.5 \times 2 = ?, \text{ i.e. } ? = 27$$

$$27 \times 2.5 = 67.5$$

6. Ans. D.

Suppose the number is x .

$$\therefore x \times \frac{3}{5} \times \frac{60}{100} \times \frac{40}{100} = 504$$

$$\therefore x = \frac{504 \times 5 \times 100 \times 100}{3 \times 60 \times 40} = 3500$$

$$\therefore x \times \frac{2}{5} \times \frac{25}{100} = 3500 \times \frac{2}{5} \times \frac{25}{100} [\because x = 3500]$$

$$= 350$$

7. Ans. D.

Let Tanvi's age be x years.

\therefore Tarun's age = $x/2$

\therefore Vishal's age is $x/4$ years

After four years,

$$(x+4) = \left(\frac{x}{4} + 4\right) 2.5$$

$$\text{or, } x+4 = \frac{2.5x}{4} + 10$$

$$\text{or, } 4x+16=2.5x+40$$

$$\text{or, } 1.5x = 24$$

$$\text{or, } x = \frac{24}{1.5} = 16$$

8. Ans. C.

Suppose waste pipe can drain the cistern in x min.

Then,

$$\frac{1}{24} + \frac{1}{40} - \frac{1}{x} = \frac{1}{60}$$

$$\frac{1}{x} = \frac{1}{24} + \frac{1}{40} - \frac{1}{60}$$

$$\frac{1}{x} = \frac{5+3-2}{120}$$

$$\frac{1}{x} = \frac{6}{120} = \frac{1}{20}$$

$$x = 20 \text{ min}$$

\therefore Waste pipe can drain of 30L/min.

Hence, capacity of the cistern = $30 \times 20 = 600 \text{ L}$

9. Ans. A.

$$L=50\text{km}$$

$$T_1=2\text{hr}$$

$$T_2=5\text{hr}$$

$$\text{Speed of boat} = (L/2) \times \left\{ \left(\frac{1}{T_1} \right) + \left(\frac{1}{T_2} \right) \right\}$$

$$= (50/2) \times \left\{ \left(\frac{1}{2} \right) + \left(\frac{1}{5} \right) \right\} = 17.5 \text{ km/hr}$$

$$\text{Distance covered} = 3 \times 17.5 \text{ km} = 52.5 \text{ km}$$

10. Ans. D.

According to the question,

$$A_1 - A_2 = 5000 - 2000$$

$$\left(P + \frac{P \times 12 \times T}{100} \right) - \left(P + \frac{P \times 4 \times T}{100} \right) = 5000 - 2000$$

$$\Rightarrow \frac{8PT}{100} = 3000$$

$$\Rightarrow PT = \frac{3000 \times 100}{8} = 37500$$

$$\text{Again, for 12\% rate, SI} = \frac{PTR}{100} = \frac{37500 \times 12}{100}$$

$$\Rightarrow \text{SI} = \text{Rs. } 4500$$

$$\therefore \text{Sum (P)} = 5000 - 4500 = \text{Rs. } 500$$

$$\text{We have, } PT = 37500$$

$$\therefore T = \frac{37500}{P} = \frac{37500}{500} = 75 \text{ yr}$$

11. Ans. E.

Average = Sum of observations/Number of observations

Given, average wage of a worker during a fortnight comprising 15 consecutive working days was Rs. 95 per day.

Total wage he received in the fortnight = $15 \times 95 = \text{Rs. } 1425$
 Also, during the first 7 days, his average was Rs. 92 per day and the average wage during the last 7 days was Rs. 97 per day.
 Total wage received in the fortnight excluding the 8th day = $92 \times 7 + 97 \times 7$
 \Rightarrow Total wage received in the fortnight excluding the 8th day = 1323
 Wage on the 8th day = Rs. $1425 - 1323 = \text{Rs. } 102$

12. Ans. D.
 Given, ratio of efficiency of P and Q i.e. 3:1 so, total efficiency of (P+Q) = 4
 Then, Ratio of time taken by P and Q is 1:3
 Let time taken by P is X days
 So time taken by Q is 3X days
 Time taken by P = time taken by Q - 60 days
 $X = 3X - 60$
 $2X = 60$
 $X = 30$ days
 $\text{Eff.}_{P+Q} \times T_{P+Q} = \text{Eff.}_P \times T_P$
 $4 \times T_{P+Q} = 3 \times 30$
 $T_{P+Q} = 90$ days
 $T_{P+Q} = (90/4)$ days
 $T_{P+Q} = 22(1/2)$ days

13. Ans. C.
 Let l be the numerator and m be the denominator of a fraction F

$$F = \frac{l}{m}$$
 Let l is increased by 150% so it would become $250 \times l / 100 = 5l/2$
 Let m is increased by 350% so it would become $450 \times m / 100 = 9m/2$
 Hence new fraction = $5l/9m = 25/51$
 $l/m = 15/17$

14. Ans. A.
 Suppose, the monthly salary of Ms. Deepti is x rupees.

$$x \times \frac{11}{100} = 5236$$

$$x = \frac{5236 \times 100}{11}$$

$$x = ₹ 47600$$

∴ Total annual amount invested by Ms. Deepti

$$= 47600 \left(\frac{11}{100} + \frac{19}{100} + \frac{7}{100} \right) \times 12$$

$$= 47600 \times \frac{37}{100} \times 12$$

$$= 476 \times 37 \times 12$$

$$= ₹ 211344$$

15. Ans. D.
 Let the cost price of 1 kg item be x.
 So cost price of 600g item = 0.6x.
 According to the question the Selling Price of 600 g of item = Cost price of 1 kg item = x.

$$\text{So, Profit \%} = \frac{x - 0.6x}{0.6x} \times 100 = 66.7\%$$

16. Ans. A.
 No. of employees working in legal deptt.
 $= 48 + 54 + 36 + 30 + 53 = 221$
 and no. of employees working in H.R.
 $= 1050 + 1015 + 976 + 888 + 1004 = 4933$
 Req. % = $(221 \times 100) / 4933 = 4$ (App)

17. Ans. B.
 Average number of people working in marketing deptt. = 1326.2
 Average number of people working in production deptt. = 1557.4
 Req. Difference = $1557.4 - 1326.2 = 231$ (app.)

18. Ans. E.
 No. of employees working in organisation A
 $= 1050 + 1017 + 1382 + 1542 + 786 + 48 = 5825$
 No. of employees working in organization E
 $= 1004 + 963 + 1290 + 1580 + 735 + 53 = 5625$
 Reqd. ratio = $5825 : 5625 = 233 : 225$

19. Ans. C.
 Total no. of employees from all the departments
 $= 5825 + 5703 + 5424 + 5613 + 5625 = 28190$

20. Ans. D.
 Reqd. % = $(960 \times 100) / 5703 = 17$ (app.)

21. Ans. A.
 $73.96 - 18.19 + 17.47 = ? + 10.91$
 $? = 73.96 - 18.19 + 17.47 - 10.91$
 $? = 55.77 + 6.56$
 $? = 62.33$

22. Ans. A.
 $? = 345 + 20 - 11$
 $? = 354$

23. Ans. D.
 $26\% \text{ of } 450 = 26 \times 450 / 100 = 26 \times 4.5 = 117.0$
 $12\% \text{ of } 150 = 12 \times 150 / 100 = 12 \times 1.5 = 18.0$
 Hence $26\% \text{ of } 450 - ? = 12\% \text{ of } 150 \rightarrow 117 - ? = 18 \rightarrow ? = 117 - 18 = 99$

24. Ans. D.
 $? = \frac{36 \times 650}{100} - \frac{14 \times 560}{100}$
 $= 234 - 78.40 = 155.6$

25. Ans. C.
 $135 + 167 - 32 = ? - 113$
 $\Rightarrow ? = 270 + 113 = 383$

26. Ans. D.

$$7878 - 4545 + 5454 = ? + 4444$$
$$\Rightarrow 8787 = ? + 4444$$
$$\Rightarrow ? = 8787 - 4444 = \mathbf{4343}$$

27. Ans. C.

$$264 \div \sqrt{576} + (11)^2 + 12 = (x)^2$$

$$(x)^2 = \frac{264}{24} + 121 + 12 = 144$$

$$x = \sqrt{144} = 12$$

28. Ans. C.

$$7960 + 2956 - 8050 + 4028 = ?$$
$$10916 - 4022 = ?$$
$$? = 6894$$

29. Ans. C.

$$92 \times \frac{576}{72} = (?)^3 + \sqrt{49}$$

$$92 \times 8 = (?)^3 + 7$$

$$(?)^3 = 729$$

$$? = 9$$

30. Ans. D.

$$225 - 125 + 25 + 44 = ?^2$$
$$\Rightarrow 169 = ?^2$$
$$\Rightarrow ? = \mathbf{13}$$

31. Ans. D.

$$64\% \text{ of } 750 \div 4 = x \div 5$$

$$\frac{64 \times 750}{100 \times 4} = \frac{x}{5}$$

$$120 = \frac{x}{5}$$

$$x = 120 \times 5 = 600$$

32. Ans. B.

$$68 \times \sqrt{7} - 3421 = 591$$

$$\Rightarrow 68 \times \sqrt{7} = 591 + 3421$$

$$\Rightarrow \sqrt{7} = \frac{4012}{68}$$

$$\Rightarrow \sqrt{7} = 59$$

$$\Rightarrow ? = (59)^2 = 59 \times 59$$

$$\Rightarrow ? = 3481$$

Hence, option (B) is correct.

33. Ans. A.

$$? = \sqrt{18} + \sqrt{32} - \sqrt{50}$$

$$= \sqrt{3 \times 3 \times 2} + \sqrt{2 \times 2 \times 2 \times 2 \times 2} - \sqrt{5 \times 5 \times 2}$$

$$= 3\sqrt{2} + 4\sqrt{2} - 5\sqrt{2} = 2\sqrt{2}$$

Hence Option A is correct

34. Ans. E.

$$? = (41 \times 72) / (8 \times 3) = 123$$

Hence Option E is correct

35. Ans. B.

$$? = 31 + 48/8 - 18$$

$$\Rightarrow 31 + 6 - 18 = 19$$

Hence Option B is correct

36. Ans. A.

$M \geq K > T = P$ hence $M > P$ follows.

$T = P \leq S = R$ hence $T \leq R$ so $T < R$ does not follow.

37. Ans. B.

We can't establish any specific relation between S & G.
So conclusion I does not follow.

$G \leq R \leq L = T$ hence $G \leq T$ follows.

38. Ans. E.

$D = K \geq R > T = P$ hence $D > P$ follows.

$Q \leq P = T < R$ hence $R > Q$ follows.

39. Ans. C.

$M \leq N \leq R = J$ so $M \leq J$ hence either $M < J$ or $M = J$ follows.

40. Ans. D.

We can't establish any specific relation between A & K.
So conclusion I does not follow.

We can't establish any specific relation between S & Q.
So conclusion II does not follow.

41. Ans. B.

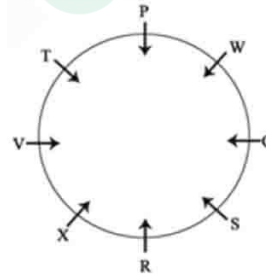

42. Ans. E.

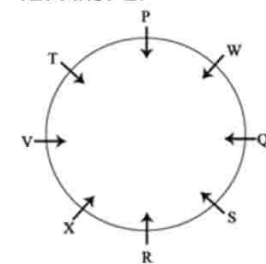

43. Ans. D.

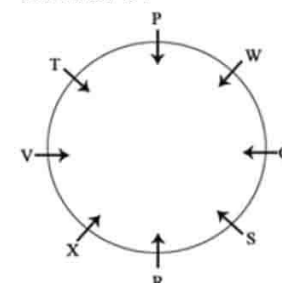

44. Ans. E.

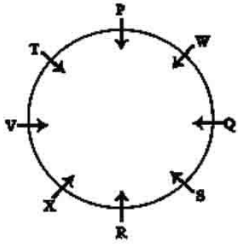

45. Ans. C.

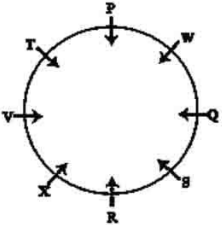

46. Ans. D.

9th to the left of 18th from the left = $(18 - 9 =)$ 9th from the left = S

47. Ans. B.

9

48. Ans. E.

2 7 9 6 8 4 3 5

49. Ans. C.

★ And ©

50. Ans. B.

In all others, the second element comes three positions after the first in the given arrangement.

51. Ans. E.

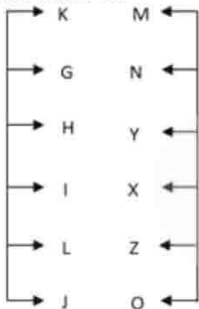

52. Ans. B.

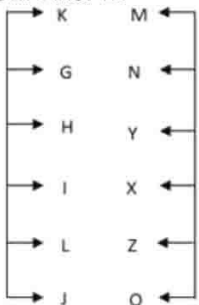

53. Ans. D.

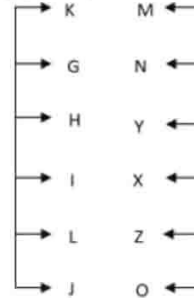

54. Ans. D.

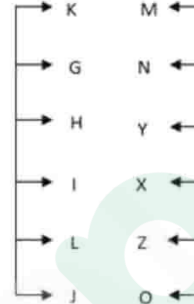

55. Ans. C.

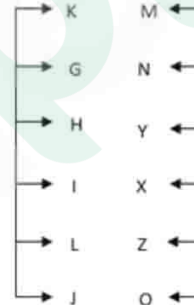

56. Ans. A.

Let all the numbers are arranged in descending order from left to right, we get: 924 816 725 563 485
725 is in the middle position after rearrangement.
Product of first and second digit of 725 = $7 \times 2 = 14$

57. Ans. C.

Let all the digits in each of the numbers are arranged in ascending order, we get: 257 249 458 168 356; clearly 458 is the highest number which was originally: 485

58. Ans. D.

Let the positions of the first and the third digits of each of the numbers are interchanged, we get: 527 429 584 618 365; clearly 527, 429 and 365 (three numbers) are odd numbers.

59. Ans. C.

Let we add one to the middle digit of each of the numbers, we get:
735 934 495 826 573, in these numbers let we divide them with 3
 $735/3 = 245$; $934/3 = 311.33$; $495/3 = 165$; $826/3 = 275.33$; $573/3 = 191$; therefore four numbers (735, 495 and 573 are divisible by 3) and remaining two numbers are not divisible by three.

60. Ans. B.

From the given numbers (725 924 485 816 563) 924 is highest and 485 is lowest number. Let we multiply first digit of highest number with third digit of lowest number, we get $9 \times 5 = 45$

61. Ans. A.

P/Football R/Hockey M/Golf O/Badminton S/Cricket T/Chess Q/Baseball N/Tennis

62. Ans. C.

P/Football R/Hockey M/Golf O/Badminton S/Cricket T/Chess Q/Baseball N/Tennis

63. Ans. A.

P/Football R/Hockey M/Golf O/Badminton S/Cricket T/Chess Q/Baseball N/Tennis

64. Ans. B.

P/Football R/Hockey M/Golf O/Badminton S/Cricket T/Chess Q/Baseball N/Tennis

65. Ans. B.

P/Football R/Hockey M/Golf O/Badminton S/Cricket T/Chess Q/Baseball N/Tennis

66. Ans. C.

The word has been divided into two equal parts and then the order of the letters in each part is reversed and the immediate next letter is written in the code.

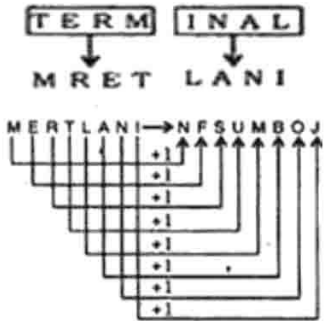

Similarly;

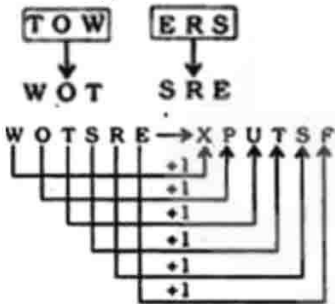

Therefore;

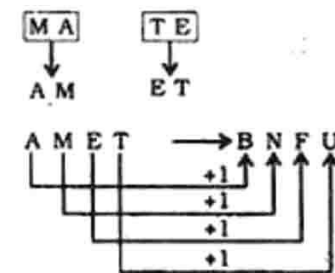

Hence Option C is correct

67. Ans. C.

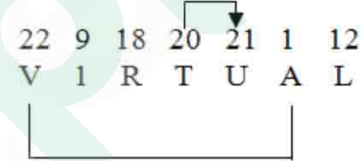

There are two case - TU & VA

68. Ans. D.

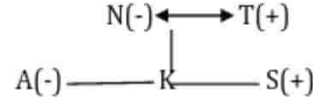

Note: K gender is not clear so can not define sons does T have

69. Ans. E.

1 2 3 4 5 6 7 8 9 10

DISCLAIMER

first, second, sixth and tenth letters are - D, I, A R

Meaningful world \Rightarrow RAID, RIAD

70. Ans. C.

Let K started at A and moved 5 m and reached at B, then he turned right and walked 10m to reach C. He again turn right and walked 20m and reached D. He Again took right turn and moved 10m and reached at E.

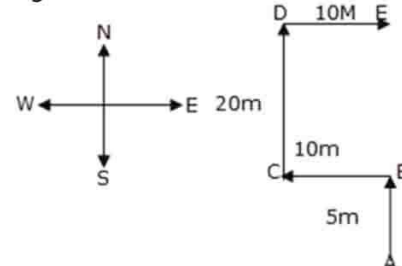

$$AE = AB + BE = AB + CD = 20 + 5 = 25 \text{ m}$$

From the figure it is clear that at point E, K at (20+5 =25m) far from the starting point .

71. Ans. A.

Refer to the last few lines of the first paragraph.

72. Ans. D.

Refer to the last few lines of the passage. It is clear that Manikya chose to work for him because he wanted to teach him a lesson.

73. Ans. E.

Refer to the last few lines of the passage.

74. Ans. A.

Manikya wanted to teach the couple a lesson as they had the habit of lying and cheating others. He wanted to teach them a lesson and show how lying destroys lives. Hence, the most apt moral of the story is lying destroys lives.

75. Ans. C.

Amrutananda and his wife, Mandakini, wish to have a celebration because they received a rich harvest and so wanted to have a feast.

76. Ans. C.

Inverted is most similar in meaning to overturned.

77. Ans. E.

Strange is the synonyms of **Odd**

78. Ans. A.

Shocked is similar in meaning to stunned.

79. Ans. C.

Innocent is the antonym of cunning.

80. Ans. B.

Proud is the antonym of ashamed.

81. Ans. C.

An image makeover to counter the opposition's allegations of it / an is used with vowels "a, e, i, o, u".

82. Ans. B.

We use 'since' to talk about a specific point in time, or a time when the action started.

83. Ans. C.

Here, Present at the should be used because 'on' means above something and 'at' is used with respect to the some occasion.

84. Ans. B.

We see that there are two subjects, history and position, hence the verb should be plural. So the verb should be 'demand' instead of 'demands'.

85. Ans. D.

Instead of writing "from their", write " from that of their".

86. Ans. C.

Use "understandably" instead of "understandingly" to change it to an adjective.

87. Ans. D.

The sentence is in the past tense. It should be 'took' instead of 'take'. The sentence should be, 'the shift in relations has been manifested most recently in the first bilateral military exercises between China and India that took place in November 2003.

88. Ans. C.

In C part , use of 'lightening' is incorrect . 'Lightning' should replace 'lightening' here. 'Lightening' refers to the process of making something lighter in colour. Whereas 'lightning' is a noun which refers to the meteorological phenomenon that is followed by thunder. Hence C is the correct choice.

89. Ans. C.

Here, the error is in part C. "why could he" will be replaced by "why he could".

90. Ans. E.

The given sentence is correct.

91. Ans. A.

Since it is the case of plural form of nouns, 'have' should be used.

92. Ans. B.

The context implies that a cavalry led by Ria's fiancé marked a tremendous victory. The news must have made Ria happy. Therefore, options A, C, D and E are not eligible as they seem to be sad and frightened. Therefore, 'impressed' is a viable option here.

93. Ans. D.

The context applies that Ria was overwhelmed with the victory of her fiancé. However, at the same time, she was worried that she might never be able to live up to her fiancé's nobility. Therefore, we need to look up synonyms of worries.

94. Ans. D.

'On' is used to refer to the surface of something. 'At' is used to indicate a place or destination. 'Of' is used to show certain relation or connection. 'Over' is used to show a place covered by something. The preposition 'through' means from one side of something to the other. Here, the Serbs are being chased 'through' the streets by the Bulgarians. Therefore, 'through' is the correct answer.

95. Ans. A.

By observing the given options, we can remove options C, D and E. It is because the sentence is written in present simple tense while these options represent tense consistency error. Between, 'threatens' and 'blackmails', 'threatens' is a more suitable response.

96. Ans. C.

Infinitives always take the base form of the verb with the preposition 'to'. In this passage 'find' cannot be the answer. Hence, search is the right choice.

97. Ans. B.

The context implies that the soldier carries chocolates into battle as a replacement to bullets. The previous line says that 'the soldier carries no cartridges. If we look carefully at the options we can find that B is the right choice.

98. Ans. E.

By observing the given options we can remove A and C because the sentence is written in simple present tense while the words are showing tense consistency error. Among the remaining, 'devours' is the most suitable response.

99. Ans. D.

The context implies that the soldier was obliged to Ria as she saved his life and therefore he should be thankful to her. Hence, the choice D is correct.

100. Ans. B.

If we carefully look at the options we can easily eliminate C, D and E, because sentence is written in simple present tense and there is a tense consistency error. The context implies that Ria wanted the "chocolate cream soldier" to climb down the drainpipe. However, he had not enough strength left. Therefore, he must have denied Ria's proposal. Hence option A is eliminated and we are left with option B as the right choice.

Prepp



Latest Sarkari jobs, Govt Exam alerts, Results and Vacancies

- ▶ Latest News and Notification
- ▶ Exam Paper Analysis
- ▶ Topic-wise weightage
- ▶ Previous Year Papers with Answer Key
- ▶ Preparation Strategy & Subject-wise Books

To know more [Click Here](#)



www.prepp.in