

National Testing Agency

Question Paper Name :	NCHM JEE 29th Aug 2020 Shift 2 Set 2
Subject Name :	NCHM JEE
Creation Date :	2020-08-29 19:36:52
Duration :	180
Total Marks :	800
Display Marks:	Yes
Share Answer Key With Delivery Engine :	Yes
Actual Answer Key :	Yes

NCHM JEE

Group Number :	1
Group Id :	40503663
Group Maximum Duration :	0
Group Minimum Duration :	180
Show Attended Group? :	No
Edit Attended Group? :	No
Break time :	0
Group Marks :	800
Is this Group for Examiner? :	No

Numerical ability and analytical aptitude

Section Id :	405036221
Section Number :	1
Section type :	Online
Mandatory or Optional :	Mandatory
Number of Questions :	28

8/29/2020

Number of Questions to be attempted :	28
Section Marks :	120
Display Number Panel :	Yes
Group All Questions :	Yes
Mark As Answered Required? :	Yes
Sub-Section Number :	1
Sub-Section Id :	405036474
Question Shuffling Allowed :	Yes

Question Number : 1 Question Id : 4050366229 Question Type : MCQ Option Shuffling : Yes Display Question Number : Yes Is Question Mandatory : No Single Line Question Option : No Option Orientation : Vertical Correct Marks : 4 Wrong Marks : 1

Which of the following number is divisible by 3 ?

Options :

40503622651. 5967013

40503622652. 541326

40503622653. 585412

40503622654. 534230

Question Number : 1 Question Id : 4050366229 Question Type : MCQ Option Shuffling : Yes Display Question Number : Yes Is Question Mandatory : No Single Line Question Option : No Option Orientation : Vertical Correct Marks : 4 Wrong Marks : 1

निम्नलिखित में से कौन-सी संख्या 3 से विभाज्य है?

Options :

40503622651. 5967013

40503622652. 541326

40503622653. 585412

40503622654. 534230

Question Number : 2 Question Id : 4050366230 Question Type : MCQ Option Shuffling : Yes Display Question Number : Yes Is Question Mandatory : No Single Line Question Option : No Option Orientation : Vertical Correct Marks : 4 Wrong Marks : 1

The sum of four consecutive even numbers A, B, C and D is 180. What is the sum of the set of next four consecutive even numbers ?

Options :

40503622655. 214

40503622656. 204

40503622657. 196

40503622658. 212

Question Number : 2 Question Id : 4050366230 Question Type : MCQ Option Shuffling : Yes Display Question Number : Yes Is Question Mandatory : No Single Line Question Option : No Option Orientation : Vertical Correct Marks : 4 Wrong Marks : 1

चार लगातार सम संख्याओं A, B, C और D का योगफल 180 है। चार आगामी लगातार सम संख्याओं का योगफल क्या है?

Options :

40503622655. 214

8/29/2020

40503622656. 204

40503622657. 196

40503622658. 212

Question Number : 3 Question Id : 4050366231 Question Type : MCQ Option Shuffling : Yes Display Question Number : Yes Is Question Mandatory : No Single Line Question Option : No Option Orientation : Vertical

Correct Marks : 4 Wrong Marks : 1

Sunil can do a piece of work in 2 days, while Saurav can do it in 3 days. They work together for a day and rest of the work is done by Sachin in 1 day. They get Rs. 1800/- for the whole work. Find out the wage of Sachin, if wages are paid in proportion to work done.

Options :

40503622659. 150

40503622660. 400

40503622661. 250

40503622662. 300

Question Number : 3 Question Id : 4050366231 Question Type : MCQ Option Shuffling : Yes Display Question Number : Yes Is Question Mandatory : No Single Line Question Option : No Option Orientation : Vertical

Correct Marks : 4 Wrong Marks : 1

8/29/2020

सुनील किसी कार्य को 2 दिनों में कर सकता है, जबकि सौरभ इसी कार्य को 3 दिनों में कर सकता है। वे दोनों मिलकर इस कार्य को एक दिन करते हैं और शेष कार्य को सचिन द्वारा एक दिन में किया जाता है। यदि संपूर्ण कार्य के लिए वे रु. 1800/- प्राप्त करते हैं, तो सचिन की मजदूरी क्या होगी, अगर मजदूरी किए गए कार्य के अनुपात में अदा की जाती है।

Options :

40503622659. 150

40503622660. 400

40503622661. 250

40503622662. 300

Question Number : 4 Question Id : 4050366232 Question Type : MCQ Option Shuffling : Yes Display Question Number : Yes Is Question Mandatory : No Single Line Question Option : No Option Orientation : Vertical

Correct Marks : 4 Wrong Marks : 1

The simple interest on a sum of money is equal to the Principal and the number of year is equal to the rate percent per annum.

The rate percent is :

Options :

40503622663. 25%

40503622664. 100%

40503622665. 10%

40503622666. 12%

Question Number : 4 Question Id : 4050366232 Question Type : MCQ Option Shuffling : Yes Display Question Number : Yes Is Question Mandatory : No Single Line Question Option : No Option Orientation : Vertical

Correct Marks : 4 Wrong Marks : 1

किसी राशि पर साधारण ब्याज मूलधन के बराबर है
और वर्ष संख्या प्रति वर्ष ब्याज प्रतिशत के बराबर है।
दर प्रतिशत क्या है?

Options :

40503622663. 25%

40503622664. 100%

40503622665. 10%

40503622666. 12%

Question Number : 5 Question Id : 4050366233 Question Type : MCQ Option Shuffling : Yes Display Question Number : Yes Is Question Mandatory : No Single Line Question Option : No Option Orientation : Vertical

Correct Marks : 4 Wrong Marks : 1

What will be the simple interest for 1 year
and 4 months on the sum of Rs 25800/- at
the rate of 14% per annum ?

Options :

40503622667. Rs 4816

40503622668. Rs 2580

40503622669. Rs 4818

40503622670. Rs 4518

Question Number : 5 Question Id : 4050366233 Question Type : MCQ Option Shuffling : Yes Display Question Number : Yes Is Question Mandatory : No Single Line Question Option : No Option Orientation : Vertical

Correct Marks : 4 Wrong Marks : 1

14% प्रतिवर्ष की दर से रु. 25800/- की राशि पर 1 वर्ष और 4 माह के लिए साधारण ब्याज क्या होगा ?

Options :

40503622667. रु. 4816

40503622668. रु. 2580

40503622669. रु. 4818

40503622670. रु. 4518

Question Number : 6 Question Id : 4050366234 Question Type : MCQ Option Shuffling : Yes Display Question Number : Yes Is Question Mandatory : No Single Line Question Option : No Option Orientation : Vertical

Correct Marks : 4 Wrong Marks : 1

Simple Interest on Rs 800 for 4 years and on Rs 800 for 2 years combined together is Rs 192. Find the rate of interest.

Options :

40503622671. 5%

40503622672. 4%

40503622673. 5.8%

40503622674. 6.5%

Question Number : 6 Question Id : 4050366234 Question Type : MCQ Option Shuffling : Yes Display Question Number : Yes Is Question Mandatory : No Single Line Question Option : No Option Orientation : Vertical Correct Marks : 4 Wrong Marks : 1

यदि 4 वर्षों के लिए रु. 800 पर और 2 वर्षों के लिए रु. 800 दोनों पर साधारण ब्याज मिलाकर रु. 192 है, तब ब्याज दर बताइए।

Options :

40503622671. 5%

40503622672. 4%

40503622673. 5.8%

40503622674. 6.5%

Question Number : 7 Question Id : 4050366235 Question Type : MCQ Option Shuffling : Yes Display Question Number : Yes Is Question Mandatory : No Single Line Question Option : No Option Orientation : Vertical Correct Marks : 4 Wrong Marks : 1

Father is nine times as old as his son and the mother is eight times as old as the son. The sum of the father's and the mother's age is 51 years. What is the age of the son ?

8/29/2020

Options :

40503622675. 7 yrs

40503622676. 5 yrs

40503622677. 4 yrs

40503622678. 3 yrs

Question Number : 7 Question Id : 4050366235 Question Type : MCQ Option Shuffling : Yes Display Question Number : Yes Is Question Mandatory : No Single Line Question Option : No Option Orientation : Vertical

Correct Marks : 4 Wrong Marks : 1

एक पिता अपने पुत्र से आयु में नौ गुना अधिक बड़ा है
और माता अपने पुत्र से आठ गुना अधिक बड़ी है।
पिता और माता की आयु का योगफल 51 वर्ष है। पुत्र
की आयु क्या है?

Options :

40503622675. 7 वर्ष

40503622676. 5 वर्ष

40503622677. 4 वर्ष

40503622678. 3 वर्ष

Question Number : 8 Question Id : 4050366236 Question Type : MCQ Option Shuffling : Yes Display Question Number : Yes Is Question Mandatory : No Single Line Question Option : No Option Orientation : Vertical

Correct Marks : 4 Wrong Marks : 1

8/29/2020

The ratio between the present ages of Simran and Smriti is 3 : 7, respectively. After 4 years Smriti's age will be 39 years, What was Simran's age 4 years ago ?

Options :

40503622679. 12 yrs

40503622680. 13 yrs

40503622681. 19 yrs

40503622682. 11 yrs

Question Number : 8 Question Id : 4050366236 Question Type : MCQ Option Shuffling : Yes Display Question Number : Yes Is Question Mandatory : No Single Line Question Option : No Option Orientation : Vertical Correct Marks : 4 Wrong Marks : 1

सिमरन और स्मृति की वर्तमान आयु, के बीच अनुपात क्रमशः 3 : 7 है। 4 वर्षों के बाद स्मृति की आयु 39 हो जाएगी। सिमरन की आयु 4 वर्ष पहले कितनी थी ?

Options :

40503622679. 12 वर्ष

40503622680. 13 वर्ष

40503622681. 19 वर्ष

40503622682. 11 वर्ष

Question Number : 9 Question Id : 4050366237 Question Type : MCQ Option Shuffling : Yes Display Question Number : Yes Is Question Mandatory : No Single Line Question Option : No Option Orientation : Vertical

Correct Marks : 4 Wrong Marks : 1

The difference between the ages of two persons is 10 years. Fifteen years ago the elder one was twice as old as the younger one. The present age of the elder person is :

Options :

40503622683. 35 yrs

40503622684. 25 yrs

40503622685. 55 yrs

40503622686. 45 yrs

Question Number : 9 Question Id : 4050366237 Question Type : MCQ Option Shuffling : Yes Display Question Number : Yes Is Question Mandatory : No Single Line Question Option : No Option Orientation : Vertical

Correct Marks : 4 Wrong Marks : 1

दो व्यक्तियों की आयु के बीच अंतर 10 वर्षों का है। पन्द्रह वर्ष पहले ज्येष्ठ व्यक्ति कनिष्ठ व्यक्ति से दुगुना अधिक आयु का था। ज्येष्ठ व्यक्ति की वर्तमान आयु है।

Options :

40503622683. 35 वर्ष

40503622684. 25 वर्ष

40503622685. 55 वर्ष

40503622686. 45 वर्ष

Question Number : 10 Question Id : 4050366238 Question Type : MCQ Option Shuffling : Yes Display Question Number : Yes Is Question Mandatory : No Single Line Question Option : No Option Orientation : Vertical Correct Marks : 4 Wrong Marks : 1

The average of 7 consecutive numbers is 20.

The largest of these numbers is :

Options :

40503622687. 20

40503622688. 22

40503622689. 23

40503622690. 24

Question Number : 10 Question Id : 4050366238 Question Type : MCQ Option Shuffling : Yes Display Question Number : Yes Is Question Mandatory : No Single Line Question Option : No Option Orientation : Vertical Correct Marks : 4 Wrong Marks : 1

7 क्रमागत संख्याओं का औसत 20 है। इन संख्याओं में

सबसे बड़ी है :

Options :

40503622687. 20

40503622688. 22

8/29/2020

40503622689. 23

40503622690. 24

Question Number : 11 Question Id : 4050366239 Question Type : MCQ Option Shuffling : Yes Display Question Number : Yes Is Question Mandatory : No Single Line Question Option : No Option Orientation : Vertical

Correct Marks : 4 Wrong Marks : 1

A man bought number of Oranges half at Rs 3/- per piece and other half at Rs 2/- per piece. At what price per dozen should he sell then to make a profit of 20% ?

Options :

40503622691. Rs 30/doz

40503622692. Rs 36/doz

40503622693. Rs 40/doz

40503622694. Rs 42/doz

Question Number : 11 Question Id : 4050366239 Question Type : MCQ Option Shuffling : Yes Display Question Number : Yes Is Question Mandatory : No Single Line Question Option : No Option Orientation : Vertical

Correct Marks : 4 Wrong Marks : 1

एक व्यक्ति ने आधे संतरे रु. 3/- प्रति संतरा के मूल्य पर तथा बाकी आधे रु. 2/- प्रति संतरा के मूल्य पर खरीदे। उसे प्रति दर्जन संतरे किस मूल्य पर बेचने चाहिए कि उसे 20% का लाभ हो ?

Options :

8/29/2020

40503622691. ₹. 30/ doz

40503622692. ₹. 36/ doz

40503622693. ₹. 40/ doz

40503622694. ₹. 42/ doz

Question Number : 12 Question Id : 4050366240 Question Type : MCQ Option Shuffling : Yes Display Question Number : Yes Is Question Mandatory : No Single Line Question Option : No Option Orientation : Vertical

Correct Marks : 4 Wrong Marks : 1

A trader marks his goods 20% above the cost price and allows a discount of 15% on it. Find out the gain percent.

Options :

40503622695. 1%

40503622696. 5%

40503622697. 2%

40503622698. 6%

Question Number : 12 Question Id : 4050366240 Question Type : MCQ Option Shuffling : Yes Display Question Number : Yes Is Question Mandatory : No Single Line Question Option : No Option Orientation : Vertical

Correct Marks : 4 Wrong Marks : 1

8/29/2020

एक व्यापारी अपनी वस्तुओं की कीमत उनके लागत मूल्य से 20% अधिक निर्धारित करता है और उन पर 15% की छूट देता है। लाभ प्रतिशत बताइए।

Options :

40503622695. 1%

40503622696. 5%

40503622697. 2%

40503622698. 6%

Question Number : 13 Question Id : 4050366241 Question Type : MCQ Option Shuffling : Yes Display Question Number : Yes Is Question Mandatory : No Single Line Question Option : No Option Orientation : Vertical

Correct Marks : 4 Wrong Marks : 1

The average runs scored by a batsman in 15 innings is 48. After 16th innings his average runs become 50. How many runs does the batsman scored in 16th inning ?

Options :

40503622699. 70

40503622700. 80

40503622701. 90

40503622702. 100

Question Number : 13 Question Id : 4050366241 Question Type : MCQ Option Shuffling : Yes Display Question Number : Yes Is

Question Mandatory : No Single Line Question Option : No Option Orientation : Vertical
Correct Marks : 4 Wrong Marks : 1

एक बैट्समैन द्वारा 15 पारियों में बनाए गए रनों की औसत 48 है। 16 वीं पारी के बाद उसकी रन औसत 50 हो जाती है। बताइए कि बैट्समैन ने अपनी 16 वीं पारी में कितने रन बनाए ?

Options :

40503622699. 70

40503622700. 80

40503622701. 90

40503622702. 100

Question Number : 14 Question Id : 4050366242 Question Type : MCQ Option Shuffling : Yes Display Question Number : Yes Is
Question Mandatory : No Single Line Question Option : No Option Orientation : Vertical

Correct Marks : 4 Wrong Marks : 1

On the day of independence, sweets were to be equally distributed amongst 300 children, but on the day 50 children were absent, so each child got one extra sweet.

How many sweets were distributed ?

Options :

40503622703. 1450

40503622704. 1700

40503622705. 1650

8/29/2020

40503622706. 1500

Question Number : 14 Question Id : 4050366242 Question Type : MCQ Option Shuffling : Yes Display Question Number : Yes Is Question Mandatory : No Single Line Question Option : No Option Orientation : Vertical

Correct Marks : 4 Wrong Marks : 1

स्वतंत्रता दिवस पर 300 बच्चों में मिठाई बराबर रूप में बाँटी जानी थी, लेकिन उस दिन 50 बच्चे अनुपस्थित थे जिसके कारण प्रत्येक बच्चे को एक मिठाई का टुकड़ा और मिल गया। मिठाई कितनी बाँटी गई।

Options :

40503622703. 1450

40503622704. 1700

40503622705. 1650

40503622706. 1500

Question Number : 15 Question Id : 4050366243 Question Type : MCQ Option Shuffling : Yes Display Question Number : Yes Is Question Mandatory : No Single Line Question Option : No Option Orientation : Vertical

Correct Marks : 4 Wrong Marks : 1

The average of marks of a student in 7 subjects is 75. His average marks in 6 subjects excluding Science is 72. How many marks did he score in Science ?

Options :

40503622707. 84

8/29/2020

40503622708. 87

40503622709. 90

40503622710. 93

Question Number : 15 Question Id : 4050366243 Question Type : MCQ Option Shuffling : Yes Display Question Number : Yes Is Question Mandatory : No Single Line Question Option : No Option Orientation : Vertical Correct Marks : 4 Wrong Marks : 1

एक विद्यार्थी के सात विषयों के अंकों की औसत 75 है। विज्ञान को छोड़कर 6 विषयों में उसके औसत अंक 72 हैं। उसने विज्ञान में कितने अंक प्राप्त किए?

Options :

40503622707. 84

40503622708. 87

40503622709. 90

40503622710. 93

Question Number : 16 Question Id : 4050366244 Question Type : MCQ Option Shuffling : Yes Display Question Number : Yes Is Question Mandatory : No Single Line Question Option : No Option Orientation : Vertical Correct Marks : 4 Wrong Marks : 1

If the price of the petrol is increased by 30%, by how much percent a car owner must reduce his consumption in order to maintain the same budget?

8/29/2020

Options :

40503622711. 21%

40503622712. $21\frac{1}{3}\%$

40503622713. $23\frac{1}{13}\%$

40503622714. 23%

Question Number : 16 Question Id : 4050366244 Question Type : MCQ Option Shuffling : Yes Display Question Number : Yes Is Question Mandatory : No Single Line Question Option : No Option Orientation : Vertical

Correct Marks : 4 Wrong Marks : 1

यदि पेट्रोल की कीमत 30% बढ़ जाती है, तो किसी कार के मालिक को अपनी पेट्रोल खपत को कितना प्रतिशत कम करना चाहिए ताकि उसका बजट समान रहे?

Options :

40503622711. 21%

40503622712. $21\frac{1}{3}\%$

40503622713. $23\frac{1}{13}\%$

40503622714. 23%

Question Number : 17 Question Id : 4050366245 Question Type : MCQ Option Shuffling : Yes Display Question Number : Yes Is Question Mandatory : No Single Line Question Option : No Option Orientation : Vertical

Correct Marks : 4 Wrong Marks : 1

Two candidates fought an election. One of them got 55% of the total votes and won by 432 votes. What is the total number of votes polled ?

Options :

40503622715. 4000

40503622716. 4120

40503622717. 4200

40503622718. 4320

Question Number : 17 Question Id : 4050366245 Question Type : MCQ Option Shuffling : Yes Display Question Number : Yes Is Question Mandatory : No Single Line Question Option : No Option Orientation : Vertical

Correct Marks : 4 Wrong Marks : 1

दो व्यक्तियों ने एक चुनाव लड़ा। एक को कुल मतों का 55% मत प्राप्त हुआ और वह 432 मतों से विजयी हुआ। कुल दिए गए मतों की संख्या क्या है?

Options :

40503622715. 4000

40503622716. 4120

40503622717. 4200

8/29/2020

40503622718. 4320

Question Number : 18 Question Id : 4050366246 Question Type : MCQ Option Shuffling : Yes Display Question Number : Yes Is Question Mandatory : No Single Line Question Option : No Option Orientation : Vertical

Correct Marks : 4 Wrong Marks : 1

In a school 10% of boys are equal to the one fourth of the girls. What is the ratio of the boys and girls in that school ?

Options :

40503622719. 3 : 2

40503622720. 5 : 2

40503622721. 2 : 1

40503622722. 4 : 3

Question Number : 18 Question Id : 4050366246 Question Type : MCQ Option Shuffling : Yes Display Question Number : Yes Is Question Mandatory : No Single Line Question Option : No Option Orientation : Vertical

Correct Marks : 4 Wrong Marks : 1

एक विद्यालय में 10% लड़के, लड़कियों की एक-चौथाई संख्या के बराबर हैं। उस विद्यालय में लड़कों और लड़कियों का अनुपात क्या है?

Options :

40503622719. 3 : 2

40503622720. 5 : 2

8/29/2020

40503622721. 2:1

40503622722. 4:3

Question Number : 19 Question Id : 4050366247 Question Type : MCQ Option Shuffling : Yes Display Question Number : Yes Is Question Mandatory : No Single Line Question Option : No Option Orientation : Vertical

Correct Marks : 4 Wrong Marks : 1

The price of a chair is 60% of a table. The price of a stool is 15% of the table. The stool cost is what percentage of the chair ?

Options :

40503622723. 15%

40503622724. 20%

40503622725. 25%

40503622726. 30%

Question Number : 19 Question Id : 4050366247 Question Type : MCQ Option Shuffling : Yes Display Question Number : Yes Is Question Mandatory : No Single Line Question Option : No Option Orientation : Vertical

Correct Marks : 4 Wrong Marks : 1

एक कुर्सी का मूल्य किसी मेज के मूल्य का 60% है।
एक स्टूल का मूल्य किसी मेज के मूल्य का 15% है।
स्टूल का मूल्य कुर्सी का क्या प्रतिशत है?

Options :

40503622723. 15%

8/29/2020

40503622724. 20%

40503622725. 25%

40503622726. 30%

Question Number : 20 Question Id : 4050366248 Question Type : MCQ Option Shuffling : Yes Display Question Number : Yes Is Question Mandatory : No Single Line Question Option : No Option Orientation : Vertical

Correct Marks : 4 Wrong Marks : 1

The angles of a triangle are in the ratio of
1 : 2 : 3. The largest angle of the triangle
is :

Options :

40503622727. 30°

40503622728. 60°

40503622729. 90°

40503622730. 120°

Question Number : 20 Question Id : 4050366248 Question Type : MCQ Option Shuffling : Yes Display Question Number : Yes Is Question Mandatory : No Single Line Question Option : No Option Orientation : Vertical

Correct Marks : 4 Wrong Marks : 1

एक त्रिभुज के कोण 1 : 2 : 3 के अनुपात में हैं। त्रिभुज
का सबसे बड़ा कोण है :

Options :

40503622727. 30°

8/29/2020

40503622728. 60°

40503622729. 90°

40503622730. 120°

Question Number : 21 Question Id : 4050366249 Question Type : MCQ Option Shuffling : Yes Display Question Number : Yes Is Question Mandatory : No Single Line Question Option : No Option Orientation : Vertical

Correct Marks : 4 Wrong Marks : 1

If one star equal four circles and three circles equal four diamonds, then what is the ratio of star to diamond ?

Options :

40503622731. 1 : 3

40503622732. 3 : 4

40503622733. 3 : 16

40503622734. 4 : 3

Question Number : 21 Question Id : 4050366249 Question Type : MCQ Option Shuffling : Yes Display Question Number : Yes Is Question Mandatory : No Single Line Question Option : No Option Orientation : Vertical

Correct Marks : 4 Wrong Marks : 1

यदि एक तारा चार मंडलों (सर्किल) के बराबर है और तीन मंडल चार हीरको (डाइमंड) के बराबर हैं, तब हीरक से तारे का अनुपात क्या है?

Options :

40503622731. 1 : 3

40503622732. 3 : 4

40503622733. 3 : 16

40503622734. 4 : 3

Question Number : 22 Question Id : 4050366250 Question Type : MCQ Option Shuffling : Yes Display Question Number : Yes Is Question Mandatory : No Single Line Question Option : No Option Orientation : Vertical

Correct Marks : 4 Wrong Marks : 1

If the ratio of two numbers is 5 : 6 and their LCM is 480, then their HCF is :

Options :

40503622735. 20

40503622736. 16

40503622737. 6

40503622738. 5

Question Number : 22 Question Id : 4050366250 Question Type : MCQ Option Shuffling : Yes Display Question Number : Yes Is Question Mandatory : No Single Line Question Option : No Option Orientation : Vertical

Correct Marks : 4 Wrong Marks : 1

यदि दो संख्याओं का अनुपात 5 : 6 है और उनका एलसीएम 480 है, तो उनका एचसीएफ क्या है?

Options :

40503622735. 20

8/29/2020

40503622736. 16

40503622737. 6

40503622738. 5

Question Number : 23 Question Id : 4050366251 Question Type : MCQ Option Shuffling : Yes Display Question Number : Yes Is Question Mandatory : No Single Line Question Option : No Option Orientation : Vertical Correct Marks : 4 Wrong Marks : 1

The HCF of 2923 and 3239 is :

Options :

40503622739. 37

40503622740. 47

40503622741. 73

40503622742. 79

Question Number : 23 Question Id : 4050366251 Question Type : MCQ Option Shuffling : Yes Display Question Number : Yes Is Question Mandatory : No Single Line Question Option : No Option Orientation : Vertical Correct Marks : 4 Wrong Marks : 1

2923 और 3239 का एचसीएफ है :

Options :

40503622739. 37

40503622740. 47

40503622741. 73

40503622742. 79

Question Number : 24 Question Id : 4050366252 Question Type : MCQ Option Shuffling : Yes Display Question Number : Yes Is Question Mandatory : No Single Line Question Option : No Option Orientation : Vertical

Correct Marks : 4 Wrong Marks : 1

The product of two number is 4025 and their LCM is 25. Find their HCF :

Options :

40503622743. 161

40503622744. 165

40503622745. 175

40503622746. 180

Question Number : 24 Question Id : 4050366252 Question Type : MCQ Option Shuffling : Yes Display Question Number : Yes Is Question Mandatory : No Single Line Question Option : No Option Orientation : Vertical

Correct Marks : 4 Wrong Marks : 1

दो संख्याओं का गुणनफल 4025 है और उनका एलसीएम 25 है। उनका एचसीएफ बताइये।

Options :

40503622743. 161

40503622744. 165

40503622745. 175

40503622746. 180

Sub-Section Number : 2
Sub-Section Id : 405036475
Question Shuffling Allowed : Yes

Question Id : 4050366253 Question Type : COMPREHENSION Sub Question Shuffling Allowed : Yes Group Comprehension Questions : No

Question Numbers : (25 to 27)

Question Label : Comprehension

.

Sub questions

Question Number : 25 Question Id : 4050366254 Question Type : MCQ Option Shuffling : Yes Display Question Number : Yes Is Question Mandatory : No Single Line Question Option : No Option Orientation : Vertical

Correct Marks : 4 Wrong Marks : 1

Study the following bar graph carefully and answer the questions that follow :

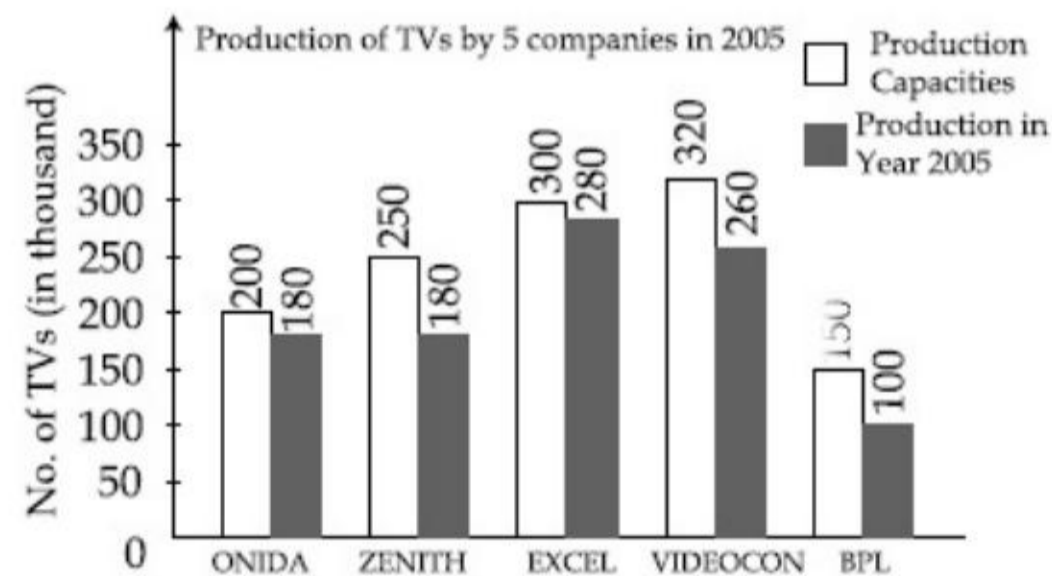

In year 2005, which company had the maximum percentage of unutilized capacity ?

8/29/2020

Options :

40503622747. Onida

40503622748. Zenith

40503622749. Excel

40503622750. BPL

Question Number : 26 Question Id : 4050366255 Question Type : MCQ Option Shuffling : Yes Display Question Number : Yes Is Question Mandatory : No Single Line Question Option : No Option Orientation : Vertical

Correct Marks : 4 Wrong Marks : 1

Study the following bar graph carefully and answer the questions that follow :

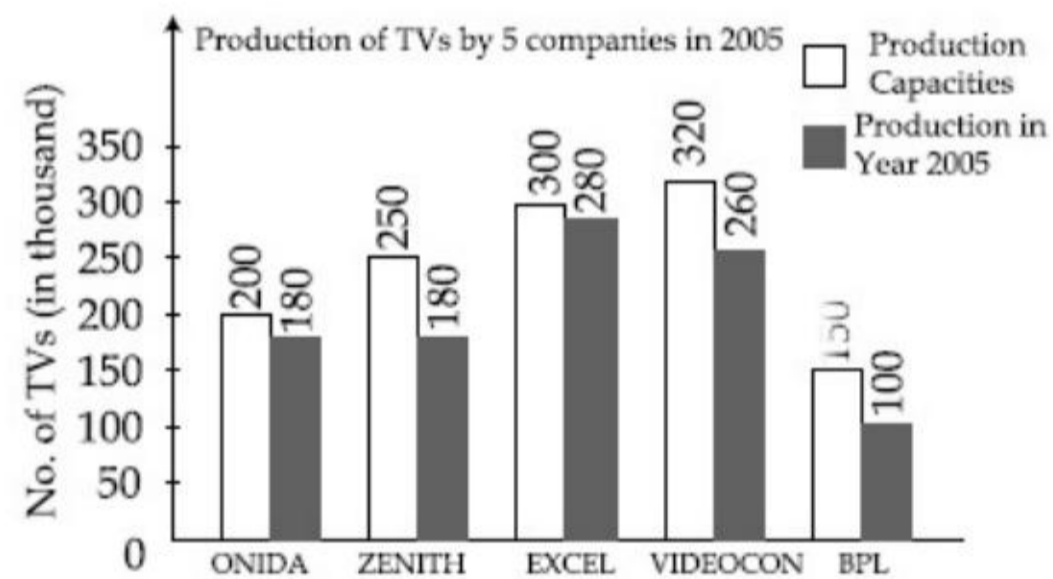

In year 2005, which company had the minimum percentage of unutilized capacity ?

Options :

40503622751. Onida

8/29/2020

40503622752. Excel

40503622753. Videocon

40503622754. BPL

Question Number : 27 Question Id : 4050366256 Question Type : MCQ Option Shuffling : Yes Display Question Number : Yes Is Question Mandatory : No Single Line Question Option : No Option Orientation : Vertical Correct Marks : 4 Wrong Marks : 1

Study the following bar graph carefully and answer the questions that follow :

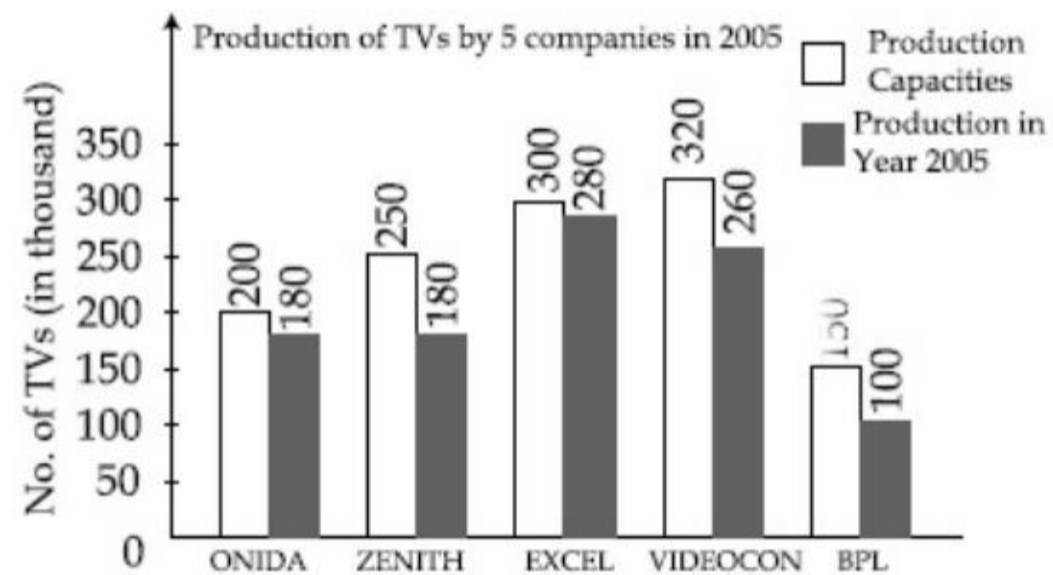

The TVs produced by 'Excel' form what percentage of the total production ?

Options :

40503622755. 25%

40503622756. 30%

40503622757. 28%

8/29/2020

40503622758. 26%

Question Id : 4050366253 Question Type : COMPREHENSION Sub Question Shuffling Allowed : Yes Group Comprehension Questions : No

Question Numbers : (25 to 27)

Question Label : Comprehension

Sub questions

Question Number : 25 Question Id : 4050366254 Question Type : MCQ Option Shuffling : Yes Display Question Number : Yes Is Question Mandatory : No Single Line Question Option : No Option Orientation : Vertical

Correct Marks : 4 Wrong Marks : 1

निर्देश : निम्नलिखित बार-ग्राफ का सावधानी से पठन करें और उसके पश्चात प्रश्नों के उत्तर दें।

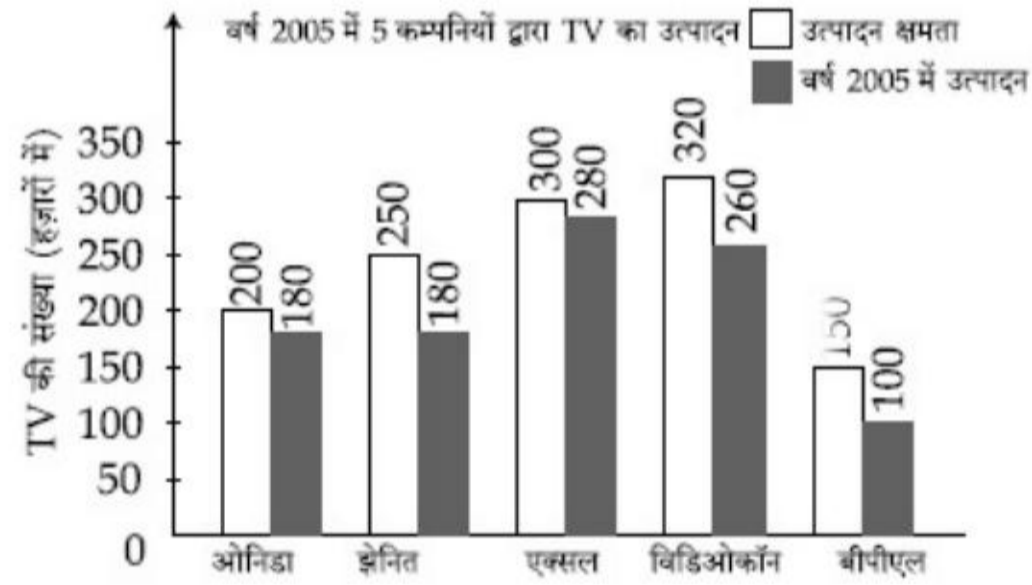

वर्ष 2005 में, किस कम्पनी का प्रयोग में न आनेवाली क्षमता का अधिकतम प्रतिशत है?

Options :

40503622747. ओनिडा

40503622748. झेनित

40503622749. एक्सल

40503622750. बीपीएल

Question Number : 26 Question Id : 4050366255 Question Type : MCQ Option Shuffling : Yes Display Question Number : Yes Is Question Mandatory : No Single Line Question Option : No Option Orientation : Vertical Correct Marks : 4 Wrong Marks : 1

निर्देश : निम्नलिखित बार-ग्राफ का सावधानी से पठन करें और उसके पश्चात प्रश्नों के उत्तर दें।

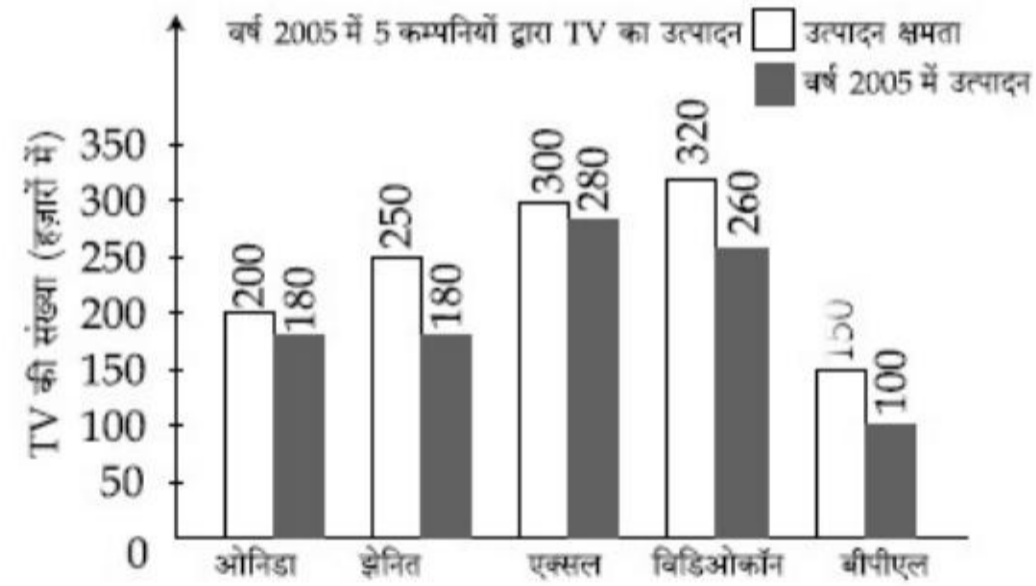

वर्ष 2005 में, किस कम्पनी का प्रयोग में न आनेवाली क्षमता का न्यूनतम प्रतिशत है?

Options :

40503622751. ओनिडा

40503622752. एक्सल

40503622753. विडिओकॉन

40503622754. बीपीएल

Question Number : 27 Question Id : 4050366256 Question Type : MCQ Option Shuffling : Yes Display Question Number : Yes Is Question Mandatory : No Single Line Question Option : No Option Orientation : Vertical Correct Marks : 4 Wrong Marks : 1

निर्देश : निम्नलिखित बार-ग्राफ का सावधानी से पठन करें और उसके पश्चात प्रश्नों के उत्तर दें।

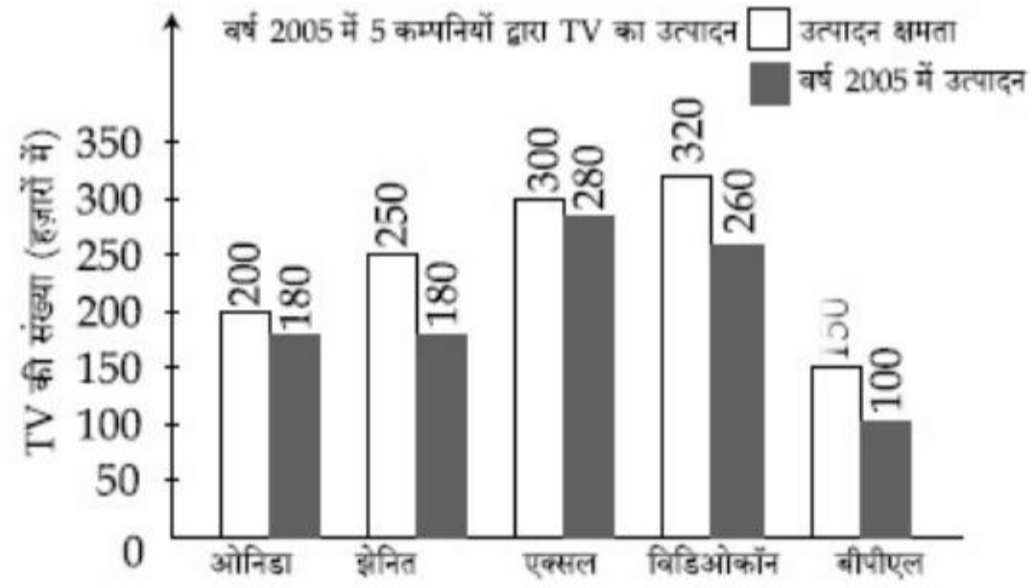

कुल उत्पादन में से, एक्सल (Excel) द्वारा निर्मित TV का कितना प्रतिशत बनता है?

Options :

40503622755. 25%

40503622756. 30%

8/29/2020

40503622757. 28%

40503622758. 26%

Sub-Section Number : 3
Sub-Section Id : 405036476
Question Shuffling Allowed : Yes

Question Number : 28 Question Id : 4050366257 Question Type : MCQ Option Shuffling : Yes Display Question Number : Yes Is Question Mandatory : No Single Line Question Option : No Option Orientation : Vertical Correct Marks : 4 Wrong Marks : 1

$$\frac{\sqrt{81}}{11} \times \frac{\sqrt{121}}{9} =$$

Options :

40503622759. 3

40503622760. 5

40503622761. 1

40503622762. 7

Question Number : 28 Question Id : 4050366257 Question Type : MCQ Option Shuffling : Yes Display Question Number : Yes Is Question Mandatory : No Single Line Question Option : No Option Orientation : Vertical Correct Marks : 4 Wrong Marks : 1

$$\frac{\sqrt{81}}{11} \times \frac{\sqrt{121}}{9} =$$

Options :

40503622759. 3

8/29/2020

40503622760. 5

40503622761. 1

40503622762. 7

Question Number : 29 Question Id : 4050366258 Question Type : MCQ Option Shuffling : Yes Display Question Number : Yes Is Question Mandatory : No Single Line Question Option : No Option Orientation : Vertical

Correct Marks : 4 Wrong Marks : 1

A gardner plants 17956 trees in such a way that there are as many rows as there are trees in a row. How many rows are there ?

Options :

40503622763. 136

40503622764. 144

40503622765. 134

40503622766. 154

Question Number : 29 Question Id : 4050366258 Question Type : MCQ Option Shuffling : Yes Display Question Number : Yes Is Question Mandatory : No Single Line Question Option : No Option Orientation : Vertical

Correct Marks : 4 Wrong Marks : 1

एक माली 17956 पौधों को इस प्रकार रोपित करता है कि एक पंक्ति में जितने पौधे हैं, उतनी ही पंक्तियां हैं। कुल पंक्तियाँ कितनी हैं ?

Options :

40503622763. 136

8/29/2020

40503622764. 144

40503622765. 134

40503622766. 154

Question Number : 30 Question Id : 4050366259 Question Type : MCQ Option Shuffling : Yes Display Question Number : Yes Is Question Mandatory : No Single Line Question Option : No Option Orientation : Vertical

Correct Marks : 4 Wrong Marks : 1

A General of Army wants to create a formation of square from 36562 army men. After arrangement he found some army men remained unused.

The number of army men remained unused is :

Options :

40503622767. 36

40503622768. 65

40503622769. 81

40503622770. 97

Question Number : 30 Question Id : 4050366259 Question Type : MCQ Option Shuffling : Yes Display Question Number : Yes Is Question Mandatory : No Single Line Question Option : No Option Orientation : Vertical

Correct Marks : 4 Wrong Marks : 1

8/29/2020

एक सेना का जनरल 36562 फौजियों से एक वर्ग की स्थापना कराना चाहता है। व्यवस्था के बाद उसे लगता है कि कुछ फौजियों का उपयोग नहीं किया गया। उपयोग नहीं किए गए फौजियों की संख्या है :

Options :

40503622767. 36

40503622768. 65

40503622769. 81

40503622770. 97

Reasoning and logical deduction

Section Id :	405036222
Section Number :	2
Section type :	Online
Mandatory or Optional :	Mandatory
Number of Questions :	20
Number of Questions to be attempted :	20
Section Marks :	120
Display Number Panel :	Yes
Group All Questions :	Yes
Mark As Answered Required? :	Yes
Sub-Section Number :	1
Sub-Section Id :	405036477
Question Shuffling Allowed :	Yes

Question Number : 31 Question Id : 4050366260 Question Type : MCQ Option Shuffling : Yes Display Question Number : Yes Is Question Mandatory : No Single Line Question Option : No Option Orientation : Vertical

8/29/2020

Correct Marks : 4 Wrong Marks : 1

Direction : Complete the series by replacing ___?

CD, FGH, ___?, OPQRS, UVWXYZ

Options :

40503622771. HIJK

40503622772. KLMN

40503622773. IJKL

40503622774. JKLM

Question Number : 31 Question Id : 4050366260 Question Type : MCQ Option Shuffling : Yes Display Question Number : Yes Is Question Mandatory : No Single Line Question Option : No Option Orientation : Vertical

Correct Marks : 4 Wrong Marks : 1

निर्देश : श्रृंखला में ___? को भरकर पूरा करें।

CD, FGH, ___?, OPQRS, UVWXYZ

Options :

40503622771. HIJK

40503622772. KLMN

40503622773. IJKL

40503622774. JKLM

8/29/2020

Question Number : 32 Question Id : 4050366261 Question Type : MCQ Option Shuffling : Yes Display Question Number : Yes Is Question Mandatory : No Single Line Question Option : No Option Orientation : Vertical

Correct Marks : 4 Wrong Marks : 1

Direction : Complete the series by replacing ___?___.

1YO, 6VQ, 13SS, 22PU, ___?___.

Options :

40503622775. 22 MV

40503622776. 33 MW

40503622777. 33 NW

40503622778. 44 OV

Question Number : 32 Question Id : 4050366261 Question Type : MCQ Option Shuffling : Yes Display Question Number : Yes Is Question Mandatory : No Single Line Question Option : No Option Orientation : Vertical

Correct Marks : 4 Wrong Marks : 1

निर्देश : श्रृंखला में ___?___ को भर कर पूरा करें।

1YO, 6VQ, 13SS, 22PU, ___?___.

Options :

40503622775. 22 MV

40503622776. 33 MW

40503622777. 33 NW

40503622778. 44 OV

Question Number : 33 Question Id : 4050366262 Question Type : MCQ Option Shuffling : Yes Display Question Number : Yes Is Question Mandatory : No Single Line Question Option : No Option Orientation : Vertical

Correct Marks : 4 Wrong Marks : 1

Direction : Complete the series by replacing ___?

1, 10, ____, 52, 85, 126

Options :

40503622779. 17

40503622780. 27

40503622781. 29

40503622782. 37

Question Number : 33 Question Id : 4050366262 Question Type : MCQ Option Shuffling : Yes Display Question Number : Yes Is Question Mandatory : No Single Line Question Option : No Option Orientation : Vertical

Correct Marks : 4 Wrong Marks : 1

निर्देश : श्रृंखला में ___?___ को भर कर पूरा करें।

1, 10, ____, 52, 85, 126

Options :

40503622779. 17

40503622780. 27

40503622781. 29

40503622782. 37

Question Number : 34 Question Id : 4050366263 Question Type : MCQ Option Shuffling : Yes Display Question Number : Yes Is Question Mandatory : No Single Line Question Option : No Option Orientation : Vertical

Correct Marks : 4 Wrong Marks : 1

Find out the alternative which replace the question mark.

CARS : VOLVO :: FURNITURE : ___?

Options :

40503622783. FWD

40503622784. TATA

40503622785. IKEA

40503622786. ITC

Question Number : 34 Question Id : 4050366263 Question Type : MCQ Option Shuffling : Yes Display Question Number : Yes Is Question Mandatory : No Single Line Question Option : No Option Orientation : Vertical

Correct Marks : 4 Wrong Marks : 1

प्रश्न वाचक चिन्ह के स्थान पर विकल्प का चयन करें।

कार : वोल्वो :: फर्नीचर : ___?

Options :

40503622783. एफ. डब्ल्यू डी.

40503622784. टाटा

40503622785. आइकिया

40503622786. आइटीसी

Question Number : 35 Question Id : 4050366264 Question Type : MCQ Option Shuffling : Yes Display Question Number : Yes Is Question Mandatory : No Single Line Question Option : No Option Orientation : Vertical Correct Marks : 4 Wrong Marks : 1

FIND out the alternative which will replace the question mark.

AIRLINE : AIRINDIA :: BANK : ___?

Options :

40503622787. ICICI

40503622788. HDFC

40503622789. SBI

40503622790. IDFC

Question Number : 35 Question Id : 4050366264 Question Type : MCQ Option Shuffling : Yes Display Question Number : Yes Is Question Mandatory : No Single Line Question Option : No Option Orientation : Vertical Correct Marks : 4 Wrong Marks : 1

प्रश्नवाचक चिन्ह के स्थान पर विकल्प का चयन करें।

एयरलाईन्स : एयरइंडिया :: बैंक : ___?

Options :

40503622787. आइ.सी.आइ.सी.आइ.

40503622788. एच.डी.एफ.सी.

8/29/2020

40503622789. एस. बी. आइ.

40503622790. आइ. डी. एफ. सी.

Question Number : 36 Question Id : 4050366265 Question Type : MCQ Option Shuffling : Yes Display Question Number : Yes Is Question Mandatory : No Single Line Question Option : No Option Orientation : Vertical Correct Marks : 4 Wrong Marks : 1

Direction : In the following question, certain pairs of words are given, out of which the words in all pairs except one bear a certain common relationship. Choose the pair in which the words are differently related.

Options :

40503622791. Earth : Planet

40503622792. Moon : Satellite

40503622793. Sun : Star

40503622794. Rocket : Sky

Question Number : 36 Question Id : 4050366265 Question Type : MCQ Option Shuffling : Yes Display Question Number : Yes Is Question Mandatory : No Single Line Question Option : No Option Orientation : Vertical Correct Marks : 4 Wrong Marks : 1

निर्देश : निम्नलिखित प्रश्न में, शब्दों के कुछ जोड़े दिए गए हैं इन शब्दों में से एक को छोड़कर वे सभी समान संबंध बनाते हैं, उस शब्द के जोड़े का चयन करें जिसका संबंध भिन्न हो।

Options :

40503622791. पृथ्वी : ग्रह
40503622792. चन्द्रमा : उपग्रह
40503622793. सूर्य : तारे
40503622794. रॉकेट : आकाश

Question Number : 37 Question Id : 4050366266 Question Type : MCQ Option Shuffling : Yes Display Question Number : Yes Is Question Mandatory : No Single Line Question Option : No Option Orientation : Vertical Correct Marks : 4 Wrong Marks : 1

Direction : Find out the odd among the four.

Options :

40503622795. Crab
40503622796. Oyster
40503622797. Alligator
40503622798. Tortoise

Question Number : 37 Question Id : 4050366266 Question Type : MCQ Option Shuffling : Yes Display Question Number : Yes Is Question Mandatory : No Single Line Question Option : No Option Orientation : Vertical Correct Marks : 4 Wrong Marks : 1

निर्देश : निम्नलिखित चार में से विषम की पहचान करें।

Options :

40503622795. केकड़ा

40503622796. कस्तूरा

40503622797. घाड़ियाल

40503622798. कछुवा

Question Number : 38 Question Id : 4050366267 Question Type : MCQ Option Shuffling : Yes Display Question Number : Yes Is Question Mandatory : No Single Line Question Option : No Option Orientation : Vertical Correct Marks : 4 Wrong Marks : 1

Direction : In each of the following question; which of the one is different from the rest ?

Options :

40503622799. Earth

40503622800. Mars

40503622801. Neptune

40503622802. Moon

Question Number : 38 Question Id : 4050366267 Question Type : MCQ Option Shuffling : Yes Display Question Number : Yes Is Question Mandatory : No Single Line Question Option : No Option Orientation : Vertical Correct Marks : 4 Wrong Marks : 1

निम्नलिखित प्रश्नों में से अन्य प्रश्नों से भिन्न एक प्रश्न का उल्लेख करें।

Options :

40503622799. पृथ्वी

40503622800. मंगल

40503622801. नेपच्यून

40503622802. चन्द्रमा

Question Number : 39 Question Id : 4050366268 Question Type : MCQ Option Shuffling : Yes Display Question Number : Yes Is Question Mandatory : No Single Line Question Option : No Option Orientation : Vertical Correct Marks : 4 Wrong Marks : 1

In the following number series, only one number is wrong. Find out the wrong number.

125, 126, 124, 127, 123, 129

Options :

40503622803. 126

40503622804. 124

40503622805. 123

40503622806. 129

Question Number : 39 Question Id : 4050366268 Question Type : MCQ Option Shuffling : Yes Display Question Number : Yes Is Question Mandatory : No Single Line Question Option : No Option Orientation : Vertical

Correct Marks : 4 Wrong Marks : 1

निम्नलिखित संख्या क्रमों में, केवल एक नम्बर गलत है, उसकी पहचान करें।

125, 126, 124, 127, 123, 129

Options :

40503622803. 126

40503622804. 124

40503622805. 123

40503622806. 129

Sub-Section Number :

2

Sub-Section Id :

405036478

Question Shuffling Allowed :

Yes

Question Id : 4050366269 Question Type : COMPREHENSION Sub Question Shuffling Allowed : Yes Group Comprehension Questions : No

Question Numbers : (40 to 42)

Question Label : Comprehension

Direction : Each of these questions consists of two sets. Figures A, B, C and D are set of question figures and figures (1), (2), (3) and (4) constitute the set of Answer figure. There is a definite relationship among figure A, B, C and D. Select a suitable figure from the answer figures (1), (2), (3) and (4) which establishes a similar relationship.

Sub questions

Question Number : 40 Question Id : 4050366270 Question Type : MCQ Option Shuffling : Yes Display Question Number : Yes Is Question Mandatory : No Single Line Question Option : No Option Orientation : Vertical Correct Marks : 4 Wrong Marks : 1

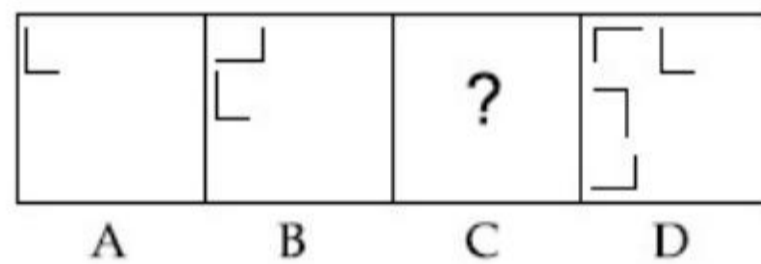

Options :

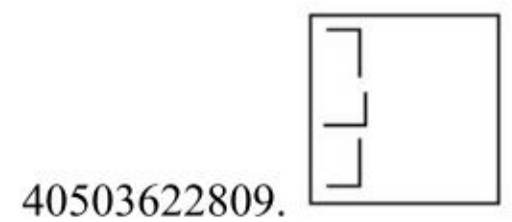
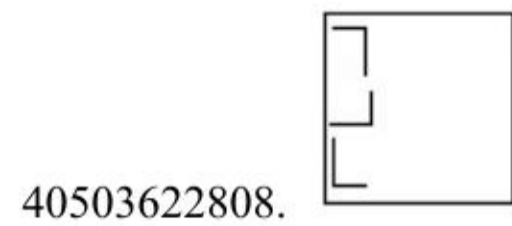
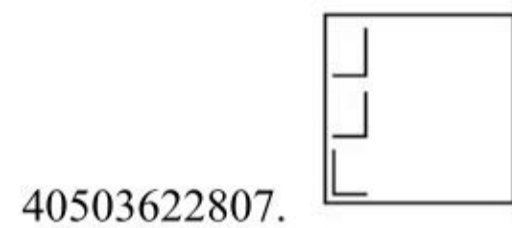

8/29/2020

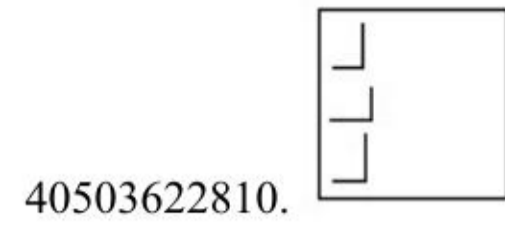

Question Number : 41 Question Id : 4050366271 Question Type : MCQ Option Shuffling : Yes Display Question Number : Yes Is Question Mandatory : No Single Line Question Option : No Option Orientation : Vertical

Correct Marks : 4 Wrong Marks : 1

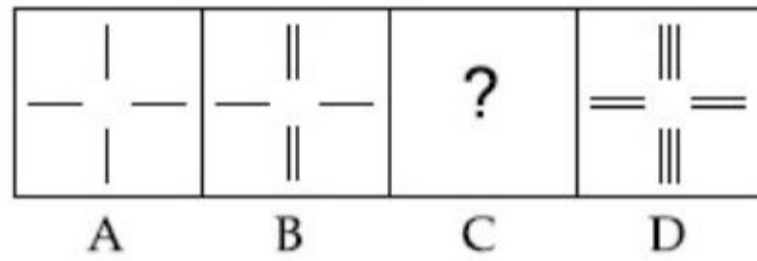

Options :

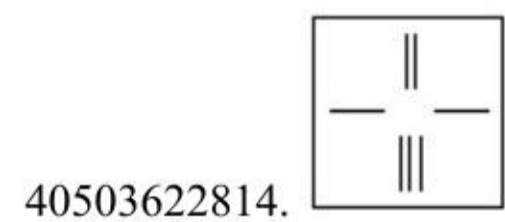
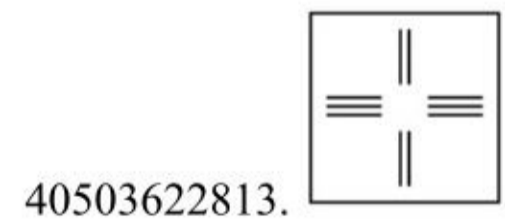
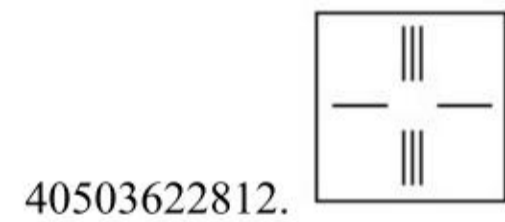
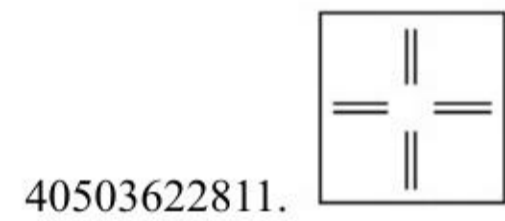

Question Number : 42 Question Id : 4050366272 Question Type : MCQ Option Shuffling : Yes Display Question Number : Yes Is Question Mandatory : No Single Line Question Option : No Option Orientation : Vertical

Correct Marks : 4 Wrong Marks : 1

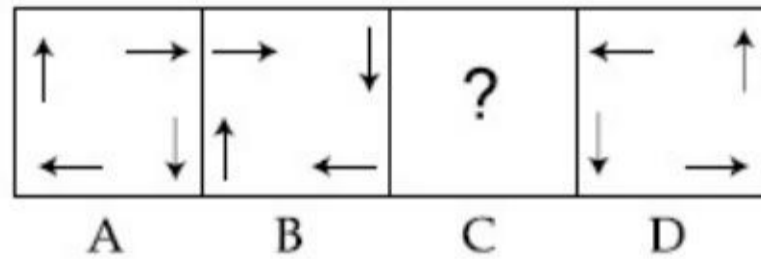

Options :

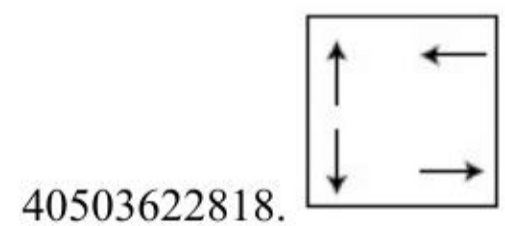
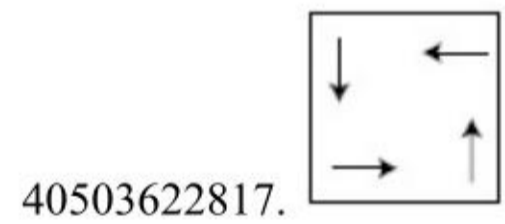
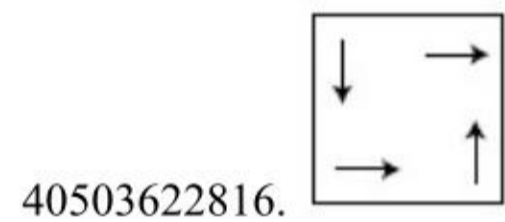
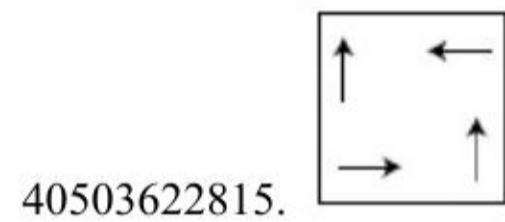

Question Id : 4050366269 Question Type : COMPREHENSION Sub Question Shuffling Allowed : Yes Group Comprehension Questions : No

Question Numbers : (40 to 42)

Question Label : Comprehension

8/29/2020

निर्देश : प्रत्येक इन प्रश्नों के दो सैट हैं चित्र A, B, C व D प्रश्न चित्रों के सैट हैं और (1), (2), (3) व (4) के उत्तर चित्र के सैट हैं चित्र A, B, C व D में निश्चित संबंध हैं उत्तर चित्रों (1), (2), (3) एवं (4) में से समान संबंध बनाने वाले उपयुक्त चित्र का चयन करें।

Sub questions

Question Number : 40 Question Id : 4050366270 Question Type : MCQ Option Shuffling : Yes Display Question Number : Yes Is Question Mandatory : No Single Line Question Option : No Option Orientation : Vertical Correct Marks : 4 Wrong Marks : 1

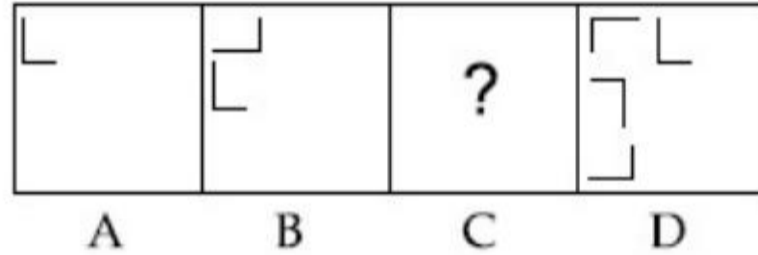

Options :

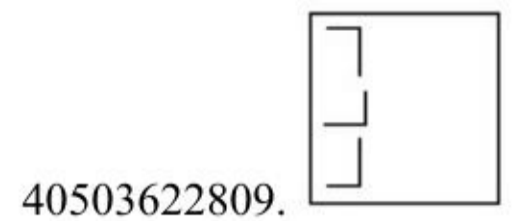
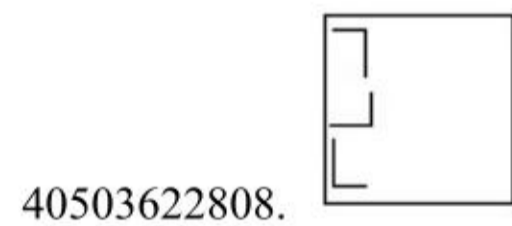
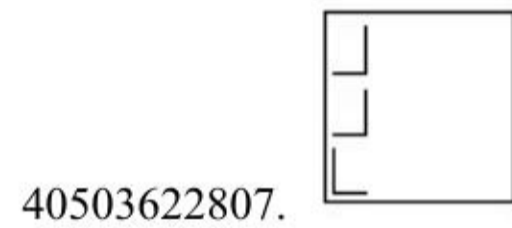

8/29/2020

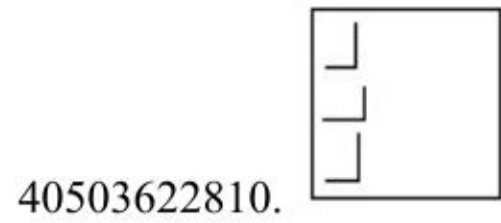

Question Number : 41 Question Id : 4050366271 Question Type : MCQ Option Shuffling : Yes Display Question Number : Yes Is Question Mandatory : No Single Line Question Option : No Option Orientation : Vertical

Correct Marks : 4 Wrong Marks : 1

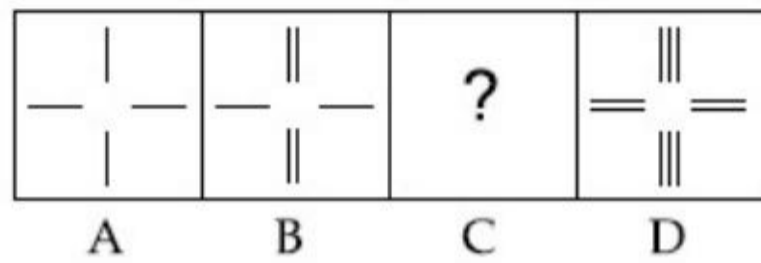

Options :

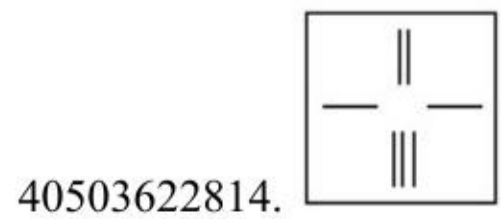
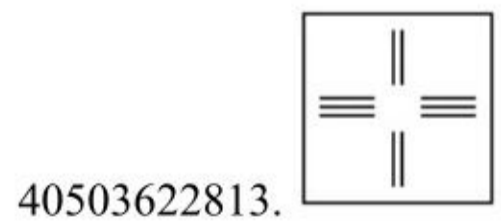
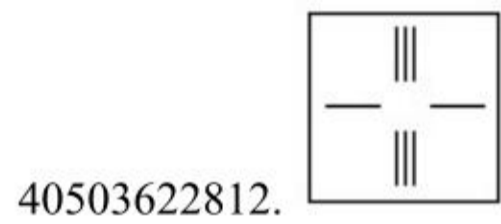
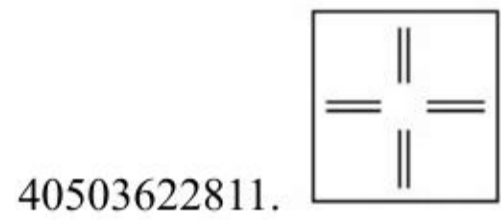

8/29/2020

Question Number : 42 Question Id : 4050366272 Question Type : MCQ Option Shuffling : Yes Display Question Number : Yes Is Question Mandatory : No Single Line Question Option : No Option Orientation : Vertical

Correct Marks : 4 Wrong Marks : 1

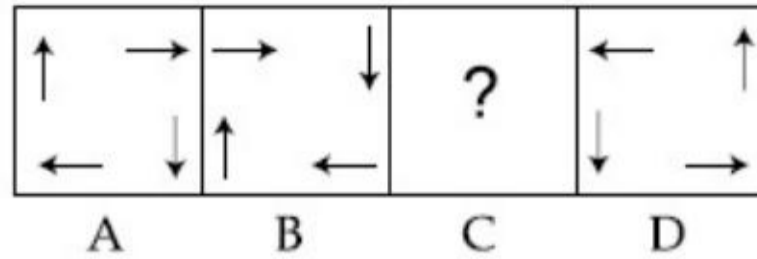

Options :

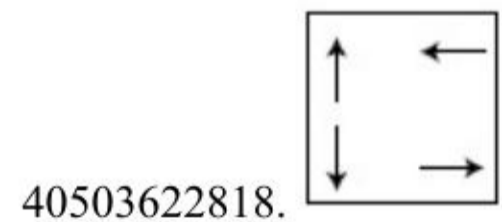
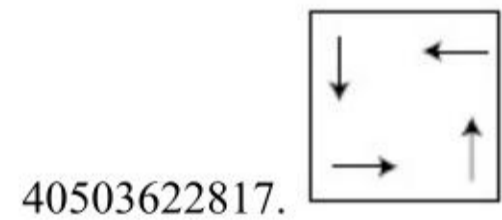
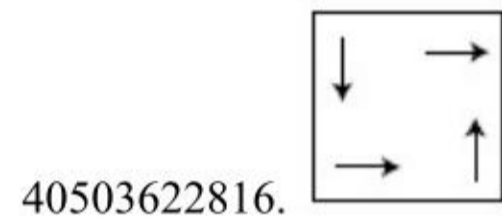
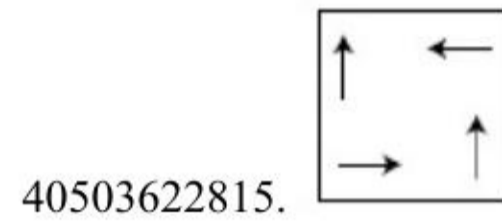

Sub-Section Number :

3

Sub-Section Id :

405036479

Question Shuffling Allowed :

Yes

Question Id : 4050366273 Question Type : COMPREHENSION Sub Question Shuffling Allowed : Yes Group Comprehension Questions : No

8/29/2020

Question Numbers : (43 to 45)

Question Label : Comprehension

Direction : Using the diagram below, answer the following question.

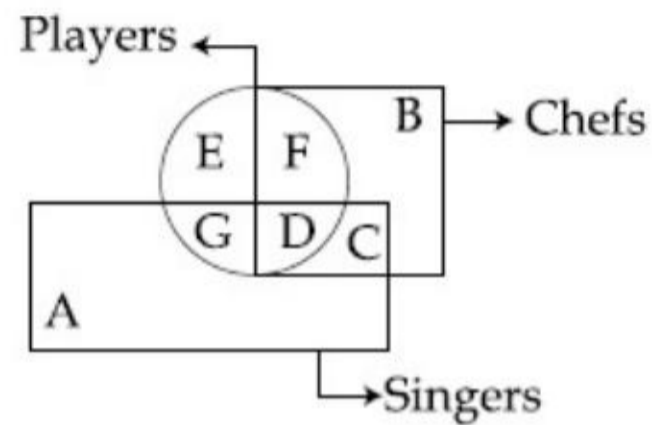

Sub questions

Question Number : 43 Question Id : 4050366274 Question Type : MCQ Option Shuffling : Yes Display Question Number : Yes Is Question Mandatory : No Single Line Question Option : No Option Orientation : Vertical

Correct Marks : 4 Wrong Marks : 1

Which space represents Chefs who are only singers ?

Options :

40503622819. (A)

40503622820. (B)

40503622821. (C)

40503622822. (D)

Question Number : 44 Question Id : 4050366275 Question Type : MCQ Option Shuffling : Yes Display Question Number : Yes Is Question Mandatory : No Single Line Question Option : No Option Orientation : Vertical

Correct Marks : 4 Wrong Marks : 1

8/29/2020

Which space in the figure represents Chefs who are singers and players ?

Options :

40503622823. (A)

40503622824. (B)

40503622825. (C)

40503622826. (D)

Question Number : 45 Question Id : 4050366276 Question Type : MCQ Option Shuffling : Yes Display Question Number : Yes Is Question Mandatory : No Single Line Question Option : No Option Orientation : Vertical

Correct Marks : 4 Wrong Marks : 1

Which space represents Chefs who are only players ?

Options :

40503622827. (F)

40503622828. (E)

40503622829. (D)

40503622830. (A)

Question Id : 4050366273 Question Type : COMPREHENSION Sub Question Shuffling Allowed : Yes Group Comprehension Questions : No

Question Numbers : (43 to 45)

8/29/2020

Question Label : Comprehension

निर्देश : निम्नलिखित आरेख के उपयोग करते हुए इस प्रश्न का उत्तर दें।

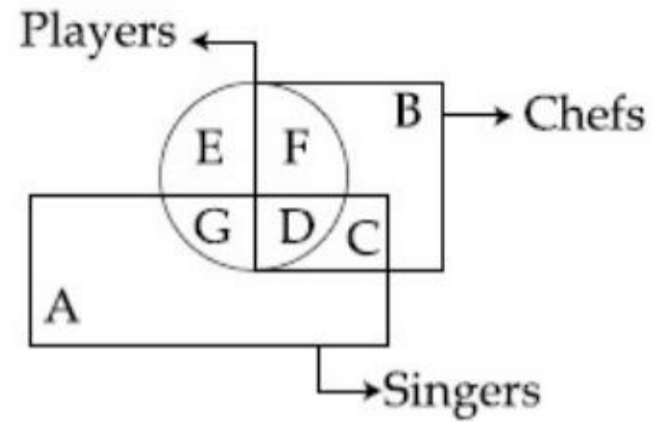

Sub questions

Question Number : 43 Question Id : 4050366274 Question Type : MCQ Option Shuffling : Yes Display Question Number : Yes Is Question Mandatory : No Single Line Question Option : No Option Orientation : Vertical

Correct Marks : 4 Wrong Marks : 1

कौन सा स्थान उस सैफ को दर्शाता है जो केवल गायक हैं?

Options :

40503622819. (A)

40503622820. (B)

40503622821. (C)

40503622822. (D)

Question Number : 44 Question Id : 4050366275 Question Type : MCQ Option Shuffling : Yes Display Question Number : Yes Is Question Mandatory : No Single Line Question Option : No Option Orientation : Vertical

Correct Marks : 4 Wrong Marks : 1

8/29/2020

चित्र में वह कौन सा स्थान है जिसमें गायक एवं खिलाड़ी
सैफो को दर्शाता है?

Options :

40503622823. (A)

40503622824. (B)

40503622825. (C)

40503622826. (D)

**Question Number : 45 Question Id : 4050366276 Question Type : MCQ Option Shuffling : Yes Display Question Number : Yes Is
Question Mandatory : No Single Line Question Option : No Option Orientation : Vertical**

Correct Marks : 4 Wrong Marks : 1

केवल खिलाड़ी वाले सैफों का स्थान को बताएं।

Options :

40503622827. (F)

40503622828. (E)

40503622829. (D)

40503622830. (A)

Sub-Section Number :

4

Sub-Section Id :

405036480

Question Shuffling Allowed :

Yes

Question Id : 4050366277 Question Type : COMPREHENSION Sub Question Shuffling Allowed : Yes Group Comprehension Questions

8/29/2020

: No

Question Numbers : (46 to 47)

Question Label : Comprehension

Direction : In each question below are given two statements followed by two conclusions numbered (I) and (II). You have to take the given 2 statements to be true even if they seem to be at variance from commonly known facts. Read the conclusion and then decide which of the given conclusions logically follows from the two given statements, disregarding commonly known facts.

Give answers :

- (1) If only conclusion (I) follows.
- (2) If only conclusion (II) follows.
- (3) If either conclusion (I) or (II) follows.
- (4) If neither conclusion (I) nor (II) follow.

Sub questions

Question Number : 46 Question Id : 4050366278 Question Type : MCQ Option Shuffling : Yes Display Question Number : Yes Is Question Mandatory : No Single Line Question Option : No Option Orientation : Vertical

Correct Marks : 4 Wrong Marks : 1

Statement :

No woman teacher can play. Some women teachers are athletes.

Conclusions :

- (I) Male athletes can play
- (II) Some athletes can play

Options :

8/29/2020

40503622831. 1

40503622832. 2

40503622833. 3

40503622834. 4

Question Number : 47 Question Id : 4050366279 Question Type : MCQ Option Shuffling : Yes Display Question Number : Yes Is Question Mandatory : No Single Line Question Option : No Option Orientation : Vertical

Correct Marks : 4 Wrong Marks : 1

Statement :

All trucks fly. All scooters fly.

Conclusions :

(I) All trucks are scooters.

(II) Some scooters do not fly.

Options :

40503622835. 1

40503622836. 2

40503622837. 3

40503622838. 4

Question Id : 4050366277 Question Type : COMPREHENSION Sub Question Shuffling Allowed : Yes Group Comprehension Questions : No

Question Numbers : (46 to 47)

Question Label : Comprehension

निर्देश : निम्नलिखित प्रत्येक प्रश्नों में दो वक्तव्य के पश्चात क्रमांक (I) व (II) के दो निष्कर्ष दिए गए हैं आपको दिए गए दो वक्तव्यों को सत्य मानना है यद्यपि उन्हें सामान्यतया ज्ञात तथ्यों से भिन्नता पाई जाती हो निष्कर्षों को पढ़ें और निर्धारित करें कि सामान्य तथा ज्ञात तथ्यों पर विचार न करते हुए दिए गए दो निष्कर्षों में से तार्किक तौर कौन सा निष्कर्ष उपयुक्त है?

उत्तर दें

- (1) यदि केवल निष्कर्ष (I) उपयुक्त है
- (2) यदि केवल निष्कर्ष (II) उपयुक्त है
- (3) यदि या तो (I) अथवा (II) निष्कर्ष उपयुक्त है
- (4) यदि न तो (I) नहीं तो (II) निष्कर्ष उपयुक्त है

Sub questions

Question Number : 46 Question Id : 4050366278 Question Type : MCQ Option Shuffling : Yes Display Question Number : Yes Is Question Mandatory : No Single Line Question Option : No Option Orientation : Vertical

Correct Marks : 4 Wrong Marks : 1

वक्तव्य :

कोई महिला अध्यापक खेल नहीं सकती कुछ महिला अध्यापक धावक हैं।

निष्कर्ष :

- (I) पुरुष धावक खेल सकते हैं
- (II) कुछ धावक खेल सकते हैं

Options :

40503622831. 1
40503622832. 2
40503622833. 3
40503622834. 4

8/29/2020

Question Number : 47 Question Id : 4050366279 Question Type : MCQ Option Shuffling : Yes Display Question Number : Yes Is Question Mandatory : No Single Line Question Option : No Option Orientation : Vertical

Correct Marks : 4 Wrong Marks : 1

वक्तव्य :

सभी ट्रक उड़ते हैं, सभी स्कूटर्स उड़ते हैं

निष्कर्ष :

(I) सभी ट्रक्स स्कूटर्स हैं।

(II) कुछ स्कूटर्स नहीं उड़ सकते।

Options :

40503622835. 1

40503622836. 2

40503622837. 3

40503622838. 4

Sub-Section Number :

5

Sub-Section Id :

405036481

Question Shuffling Allowed :

Yes

Question Id : 4050366280 Question Type : COMPREHENSION Sub Question Shuffling Allowed : Yes Group Comprehension Questions : No

Question Numbers : (48 to 50)

Question Label : Comprehension

8/29/2020

Direction : Each of these questions has an **Assertion (A)** and a **Reason (R)**. Mark answer as :

- (1) If both (A) and (R) are true and (R) is the correct explanation of (A).
- (2) If both (A) and (R) are true but (R) is not the correct explanation of (A).
- (3) If (A) is true but (R) is false.
- (4) If (A) is false but (R) is true.

Sub questions

Question Number : 48 Question Id : 4050366281 Question Type : MCQ Option Shuffling : Yes Display Question Number : Yes Is Question Mandatory : No Single Line Question Option : No Option Orientation : Vertical

Correct Marks : 4 Wrong Marks : 1

Assertion (A) :

A person with blood group 'O' is considered a universal recipient.

Reason (R) :

Type 'O' blood doesn't contain any antigens.

Options :

- 40503622839. 1
- 40503622840. 2
- 40503622841. 3
- 40503622842. 4

Question Number : 49 Question Id : 4050366282 Question Type : MCQ Option Shuffling : Yes Display Question Number : Yes Is Question Mandatory : No Single Line Question Option : No Option Orientation : Vertical

Correct Marks : 4 Wrong Marks : 1

8/29/2020

Assertion (A) :

Indian President is the head of the state.

Reason (R) :

Indian Parliament consists of the President,
Lok Sabha and Rajya Sabha.

Options :

40503622843. 1

40503622844. 2

40503622845. 3

40503622846. 4

Question Number : 50 Question Id : 4050366283 Question Type : MCQ Option Shuffling : Yes Display Question Number : Yes Is Question Mandatory : No Single Line Question Option : No Option Orientation : Vertical

Correct Marks : 4 Wrong Marks : 1

Assertion (A) :

Earth is the only planet known to have life.

Reason (R) :

Earth has an atmosphere which is a mixture
of oxygen, nitrogen and carbon dioxide.

Options :

40503622847. 1

40503622848. 2

40503622849. 3

40503622850. 4

Question Id : 4050366280 Question Type : COMPREHENSION Sub Question Shuffling Allowed : Yes Group Comprehension Questions : No

Question Numbers : (48 to 50)

Question Label : Comprehension

निर्देश : इन प्रत्येक प्रश्नों में एक कथन (A) एवं एक कारण (R) है उत्तर को चिन्हित करें।

- (1) यदि (A) व (R) दोनों सत्य हैं एवं (R), (A) का सही स्पष्टीकरण है।
- (2) यदि (A) और (R) दोनों सत्य हैं लेकिन (R), (A) का सही स्पष्टीकरण नहीं है।
- (3) यदि (A) सत्य है लेकिन (R) गलत है।
- (4) यदि (A) गलत है लेकिन (R) सत्य है।

Sub questions

Question Number : 48 Question Id : 4050366281 Question Type : MCQ Option Shuffling : Yes Display Question Number : Yes Is Question Mandatory : No Single Line Question Option : No Option Orientation : Vertical

Correct Marks : 4 Wrong Marks : 1

कथन (A) :

रक्त समूह 'O' वाले व्यक्ति को सार्वभौमिक प्राप्तक माना जाता है।

कारण (R) :

'O' रक्त समूह के प्रकार में कोई एंटीजेन्स नहीं होते है।

Options :

40503622839. 1
40503622840. 2
40503622841. 3
40503622842. 4

Question Number : 49 Question Id : 4050366282 Question Type : MCQ Option Shuffling : Yes Display Question Number : Yes Is Question Mandatory : No Single Line Question Option : No Option Orientation : Vertical

Correct Marks : 4 Wrong Marks : 1

8/29/2020

कथन (A) :

भारतीय राष्ट्रपति राज्य का मुखिया होता है।

कारण (R) :

भारतीय संसद में राष्ट्रपति, लोक सभा एवं राज्य सभा शामिल हैं।

Options :

40503622843. 1

40503622844. 2

40503622845. 3

40503622846. 4

Question Number : 50 Question Id : 4050366283 Question Type : MCQ Option Shuffling : Yes Display Question Number : Yes Is Question Mandatory : No Single Line Question Option : No Option Orientation : Vertical

Correct Marks : 4 Wrong Marks : 1

कथन (A) :

पृथ्वी को जीवन का एकमात्र ग्रह माना जाता है।

कारण (R) :

पृथ्वी के वायुमंडल में ऑक्सीजन, नाइट्रोजन एवं कार्बन डायऑक्साइड का मिश्रण पाया जाता है।

Options :

40503622847. 1

40503622848. 2

40503622849. 3

40503622850. 4

Sub-Section Number :

6

Sub-Section Id :

405036482

Question Shuffling Allowed :

Yes

Question Number : 51 Question Id : 4050366284 Question Type : MCQ Option Shuffling : Yes Display Question Number : Yes Is

8/29/2020

**Question Mandatory : No Single Line Question Option : No Option Orientation : Vertical
Correct Marks : 4 Wrong Marks : 1**

In a certain code language APPLAUSE is written as PAPLUASE. How will SPLENDID be written in that CODE ?

Options :

40503622851. SEPLNDDI

40503622852. PSLEDNID

40503622853. ELNDIDSP

40503622854. PSLEDNDI

**Question Number : 51 Question Id : 4050366284 Question Type : MCQ Option Shuffling : Yes Display Question Number : Yes Is
Question Mandatory : No Single Line Question Option : No Option Orientation : Vertical**

Correct Marks : 4 Wrong Marks : 1

कुछ विशिष्ट कोड भाषा में APPLAUSE को PAPLUASE लिखा जाता है इस कोड में SPLENDID को कैसे लिखा जाएगा ?

Options :

40503622851. SEPLNDDI

40503622852. PSLEDNID

40503622853. ELNDIDSP

40503622854. PSLEDNDI

Question Number : 52 Question Id : 4050366285 Question Type : MCQ Option Shuffling : Yes Display Question Number : Yes Is Question Mandatory : No Single Line Question Option : No Option Orientation : Vertical

Correct Marks : 4 Wrong Marks : 1

Swati is 7 ranks ahead of Raju, who ranks 36 in a class of 60. What is Swati's rank from the last ?

Options :

40503622855. 41

40503622856. 32

40503622857. 31

40503622858. 45

Question Number : 52 Question Id : 4050366285 Question Type : MCQ Option Shuffling : Yes Display Question Number : Yes Is Question Mandatory : No Single Line Question Option : No Option Orientation : Vertical

Correct Marks : 4 Wrong Marks : 1

स्वाती, राजू से 7 रैंक आगे हैं जिसकी 60 की कक्षा में 36 वां रैंक स्वाति का अंतिम से रैंक बताइए :

Options :

40503622855. 41

40503622856. 32

40503622857. 31

40503622858. 45

8/29/2020

Question Number : 53 Question Id : 4050366286 Question Type : MCQ Option Shuffling : Yes Display Question Number : Yes Is Question Mandatory : No Single Line Question Option : No Option Orientation : Vertical

Correct Marks : 4 Wrong Marks : 1

Answer the given question based on the following English alphabet :

A, B, C, D, E, F, G, H, I, J, K, L, M, N, O, P, Q, R, S, T, U, V, W, X, Y, Z.

If all the vowels are removed from the alphabet, which letter will be the fourth to the left of the sixteenth letter from the right ?

Options :

40503622859. (X)

40503622860. (B)

40503622861. (D)

40503622862. (C)

Question Number : 53 Question Id : 4050366286 Question Type : MCQ Option Shuffling : Yes Display Question Number : Yes Is Question Mandatory : No Single Line Question Option : No Option Orientation : Vertical

Correct Marks : 4 Wrong Marks : 1

निम्नलिखित अंग्रेजी वर्णाक्षरों के आधार पर प्रश्नों के उत्तर दें :

A, B, C, D, E, F, G, H, I, J, K, L, M, N, O, P, Q, R, S, T, U, V, W, X, Y, Z.

यदि वर्णाक्षरों से सभी-स्वरों को निकाल दिया जाए तो दाएं से 17 वें वर्ण के बाईं ओर से चौथा कौन सा वर्ण होगा ?

Options :

40503622859. (X)

40503622860. (B)

40503622861. (D)

40503622862. (C)

Question Number : 54 Question Id : 4050366287 Question Type : MCQ Option Shuffling : Yes Display Question Number : Yes Is Question Mandatory : No Single Line Question Option : No Option Orientation : Vertical

Correct Marks : 4 Wrong Marks : 1

Introducing Ankita to guests, Basker said
"Her father is the only son of my father"

How is Ankita related to Basker ?

Options :

40503622863. Mother

40503622864. Sister

40503622865. Daughter

40503622866. Niece

Question Number : 54 Question Id : 4050366287 Question Type : MCQ Option Shuffling : Yes Display Question Number : Yes Is Question Mandatory : No Single Line Question Option : No Option Orientation : Vertical

Correct Marks : 4 Wrong Marks : 1

अतिथियों से अंकिता का परिचय कराते हुए भास्कर ने कहा कि 'उनके पिता मेरे पिता के एकमात्र पुत्र हैं' अंकिता का भास्कर से क्या संबंध है?

Options :

40503622863. माता

40503622864. बहिन

40503622865. पुत्री

40503622866. भतीजी

Question Number : 55 Question Id : 4050366288 Question Type : MCQ Option Shuffling : Yes Display Question Number : Yes Is Question Mandatory : No Single Line Question Option : No Option Orientation : Vertical

Correct Marks : 4 Wrong Marks : 1

Blood Relation :

A woman said to a Man, "The only brother of your sister is my father". How is that women related to that Man ?

Options :

40503622867. Wife

8/29/2020

40503622868. Sister

40503622869. Mother

40503622870. Daughter

Question Number : 55 Question Id : 4050366288 Question Type : MCQ Option Shuffling : Yes Display Question Number : Yes Is Question Mandatory : No Single Line Question Option : No Option Orientation : Vertical

Correct Marks : 4 Wrong Marks : 1

रक्त संबंध

एक महिला ने एक पुरुष को बोला “कि आपकी बहिन का एकमात्र भाई मेरे पिता हैं, यह महिला ने उस व्यक्ति से क्या संबंध है?

Options :

40503622867. पत्नी

40503622868. बहिन

40503622869. माता

40503622870. पुत्री

Question Number : 56 Question Id : 4050366289 Question Type : MCQ Option Shuffling : Yes Display Question Number : Yes Is Question Mandatory : No Single Line Question Option : No Option Orientation : Vertical

Correct Marks : 4 Wrong Marks : 1

8/29/2020

Find the correct one ?

If the son of the old person, is the uncle of my son, then the old person is related to me as :

Options :

40503622871. Father

40503622872. Grand Father

40503622873. Father-in-law

40503622874. Son

Question Number : 56 Question Id : 4050366289 Question Type : MCQ Option Shuffling : Yes Display Question Number : Yes Is Question Mandatory : No Single Line Question Option : No Option Orientation : Vertical

Correct Marks : 4 Wrong Marks : 1

सही उत्तर दें।

यदि एक बुढ़े व्यक्ति का पुत्र मेरे पुत्र का चाचा है तो बुढ़े व्यक्ति का मेरे साथ क्या संबंध है?

Options :

40503622871. पिता

40503622872. दादा

40503622873. ससुर

40503622874. पुत्र

8/29/2020

Sub-Section Number : 7
Sub-Section Id : 405036483
Question Shuffling Allowed : Yes

Question Id : 4050366290 Question Type : COMPREHENSION Sub Question Shuffling Allowed : Yes Group Comprehension Questions : No

Question Numbers : (57 to 60)

Question Label : Comprehension

Study the following information carefully and answer the questions given below.

A, B, C, D, E, F and G are the seven members of the family. There are three females among them. There are two married couples in the family. Each of them has a different profession from Architect, Lawyer, Doctor, Teacher, Engineer, General Manager of a Hotel and Musician, not necessary in the same order. B is the Lawyer and he is married of F, the General Manager of a Hotel, A is brother of G, who is the architect. C is the Doctor and is an unmarried lady. D is the teacher and the sister of G. E is not an Engineer.

Sub questions

Question Number : 57 Question Id : 4050366291 Question Type : MCQ Option Shuffling : Yes Display Question Number : Yes Is Question Mandatory : No Single Line Question Option : No Option Orientation : Vertical

Correct Marks : 4 Wrong Marks : 1

Which of the following pairs represent a married couple ?

Options :

8/29/2020

40503622875. BG

40503622876. ED

40503622877. AC

40503622878. DC

Question Number : 58 Question Id : 4050366292 Question Type : MCQ Option Shuffling : Yes Display Question Number : Yes Is Question Mandatory : No Single Line Question Option : No Option Orientation : Vertical

Correct Marks : 4 Wrong Marks : 1

What is A's profession ?

Options :

40503622879. Engineer

40503622880. Musician

40503622881. Lawyer

40503622882. Teacher

Question Number : 59 Question Id : 4050366293 Question Type : MCQ Option Shuffling : Yes Display Question Number : Yes Is Question Mandatory : No Single Line Question Option : No Option Orientation : Vertical

Correct Marks : 4 Wrong Marks : 1

What is E's profession ?

Options :

40503622883. Doctor

40503622884. Musician

8/29/2020

40503622885. Teacher

40503622886. Architect

Question Number : 60 Question Id : 4050366294 Question Type : MCQ Option Shuffling : Yes Display Question Number : Yes Is Question Mandatory : No Single Line Question Option : No Option Orientation : Vertical

Correct Marks : 4 Wrong Marks : 1

Which of the following combinations represents the husbands of the two married couples ?

Options :

40503622887. (B) and (G)

40503622888. (A) and (F)

40503622889. (B) and (E)

40503622890. (D) and (C)

Question Id : 4050366290 Question Type : COMPREHENSION Sub Question Shuffling Allowed : Yes Group Comprehension Questions : No

Question Numbers : (57 to 60)

Question Label : Comprehension

निम्नलिखित सूचना को ध्यानपूर्वक पढ़ें और प्रश्नों के उत्तर दें।
A, B, C, D, E, F व G परिवार के सात सदस्य हैं इनमें तीन महिलाएँ हैं परिवार में दो विवाहित जोड़े हैं उनमें से प्रत्येक के अलग-अलग व्यवसाय आर्किटेक्ट, वकील डॉक्टर, अध्यापक इंजीनियर, महा प्रबंधक, होटल एवं संगीतकार, जिन्हें क्रम से होना आवश्यक नहीं है।

B एक वकील है और वह F से विवाहित है होटल का महाप्रबंधक A, G का भाई है जो एक आर्किटेक्ट है C डॉक्टर है और वह अविवाहित महिला हैं D एक अध्यापक है एवं G की बहिन हैं E इंजीनियर नहीं है।

Sub questions

Question Number : 57 Question Id : 4050366291 Question Type : MCQ Option Shuffling : Yes Display Question Number : Yes Is Question Mandatory : No Single Line Question Option : No Option Orientation : Vertical

Correct Marks : 4 Wrong Marks : 1

निम्नलिखित जोड़ों में से कौन विवाहित जोड़ा है?

Options :

40503622875. BG

40503622876. ED

40503622877. AC

40503622878. DC

Question Number : 58 Question Id : 4050366292 Question Type : MCQ Option Shuffling : Yes Display Question Number : Yes Is Question Mandatory : No Single Line Question Option : No Option Orientation : Vertical

Correct Marks : 4 Wrong Marks : 1

'A' का व्यवसाय क्या है?

8/29/2020

Options :

40503622879. इंजीनियर

40503622880. संगीतकार

40503622881. वकील

40503622882. अध्यापक

Question Number : 59 Question Id : 4050366293 Question Type : MCQ Option Shuffling : Yes Display Question Number : Yes Is Question Mandatory : No Single Line Question Option : No Option Orientation : Vertical Correct Marks : 4 Wrong Marks : 1

'E' का व्यवसाय क्या है?

Options :

40503622883. डॉक्टर

40503622884. संगीतकार

40503622885. अध्यापक

40503622886. आर्किटेक्ट

Question Number : 60 Question Id : 4050366294 Question Type : MCQ Option Shuffling : Yes Display Question Number : Yes Is Question Mandatory : No Single Line Question Option : No Option Orientation : Vertical Correct Marks : 4 Wrong Marks : 1

निम्नलिखित दो विवाहित जोड़ों से पतियों के सम्मिश्रण को प्रतिनिधित्व करता है :

8/29/2020

Options :

40503622887. (B) और (G)

40503622888. (A) और (F)

40503622889. (B) और (E)

40503622890. (D) और (C)

General knowledge and current affairs

Section Id :	405036223
Section Number :	3
Section type :	Online
Mandatory or Optional :	Mandatory
Number of Questions :	30
Number of Questions to be attempted :	30
Section Marks :	120
Display Number Panel :	Yes
Group All Questions :	Yes
Mark As Answered Required? :	Yes
Sub-Section Number :	1
Sub-Section Id :	405036484
Question Shuffling Allowed :	Yes

Question Number : 61 Question Id : 4050366295 Question Type : MCQ Option Shuffling : Yes Display Question Number : Yes Is Question Mandatory : No Single Line Question Option : No Option Orientation : Vertical Correct Marks : 4 Wrong Marks : 1

Who was the first Indian Woman to Climb
Mt. Everest ?

8/29/2020

Options :

40503622891. Reita Faria

40503622892. Karnam Malleswari

40503622893. Bachendri Pal

40503622894. Aarti Saha

Question Number : 61 Question Id : 4050366295 Question Type : MCQ Option Shuffling : Yes Display Question Number : Yes Is Question Mandatory : No Single Line Question Option : No Option Orientation : Vertical Correct Marks : 4 Wrong Marks : 1

माउंट एवरेस्ट में पहुँचने वाली पहली महिला कौन थी ?

Options :

40503622891. रिटा फारिया

40503622892. कर्णम मल्लेश्वरी

40503622893. बचेन्द्री पाल

40503622894. आरती साहा

Question Number : 62 Question Id : 4050366296 Question Type : MCQ Option Shuffling : Yes Display Question Number : Yes Is Question Mandatory : No Single Line Question Option : No Option Orientation : Vertical Correct Marks : 4 Wrong Marks : 1

Which of the following is the National Airline of Germany ?

Options :

8/29/2020

40503622895. Cathay Pacific

40503622896. Quantas

40503622897. Lufthansa

40503622898. Garuda

Question Number : 62 Question Id : 4050366296 Question Type : MCQ Option Shuffling : Yes Display Question Number : Yes Is Question Mandatory : No Single Line Question Option : No Option Orientation : Vertical

Correct Marks : 4 Wrong Marks : 1

निम्नलिखित में से जर्मनी की राष्ट्रीय एयरलाइन्स कौन सी है?

Options :

40503622895. कैथी पेसिफिक

40503622896. क्वांटस

40503622897. लुफ्थांसा

40503622898. गरूड

Question Number : 63 Question Id : 4050366297 Question Type : MCQ Option Shuffling : Yes Display Question Number : Yes Is Question Mandatory : No Single Line Question Option : No Option Orientation : Vertical

Correct Marks : 4 Wrong Marks : 1

Who was the first Indian Woman to get an Olympic medal ?

8/29/2020

Options :

40503622899. Aarti Saha

40503622900. Karnam Malleswari

40503622901. P.T. Usha

40503622902. Sania Mirza

Question Number : 63 Question Id : 4050366297 Question Type : MCQ Option Shuffling : Yes Display Question Number : Yes Is Question Mandatory : No Single Line Question Option : No Option Orientation : Vertical

Correct Marks : 4 Wrong Marks : 1

वह कौनसी पहली भारतीय महिला जिसने ओलंपिक पदक प्राप्त किया ?

Options :

40503622899. आरती साहा

40503622900. कर्णम मल्लेश्वरी

40503622901. पी.टी. ऊषा

40503622902. सानिया मिर्जा

Question Number : 64 Question Id : 4050366298 Question Type : MCQ Option Shuffling : Yes Display Question Number : Yes Is Question Mandatory : No Single Line Question Option : No Option Orientation : Vertical

Correct Marks : 4 Wrong Marks : 1

Myanmar was known by which name ?

Options :

8/29/2020

40503622903. Rangoon

40503622904. Burma

40503622905. Peking

40503622906. Formosa

Question Number : 64 Question Id : 4050366298 Question Type : MCQ Option Shuffling : Yes Display Question Number : Yes Is Question Mandatory : No Single Line Question Option : No Option Orientation : Vertical

Correct Marks : 4 Wrong Marks : 1

म्यांनमार को किस नाम से जाना जाता था ?

Options :

40503622903. रंगून

40503622904. बर्मा

40503622905. पेकिंग

40503622906. फारमूसा

Question Number : 65 Question Id : 4050366299 Question Type : MCQ Option Shuffling : Yes Display Question Number : Yes Is Question Mandatory : No Single Line Question Option : No Option Orientation : Vertical

Correct Marks : 4 Wrong Marks : 1

The highest commissioned rank of Naval

Services in India is :

Options :

8/29/2020

40503622907. Admiral

40503622908. Chief Marshal

40503622909. General

40503622910. Wing Commander

Question Number : 65 Question Id : 4050366299 Question Type : MCQ Option Shuffling : Yes Display Question Number : Yes Is Question Mandatory : No Single Line Question Option : No Option Orientation : Vertical

Correct Marks : 4 Wrong Marks : 1

भारत में नौ सेना के उच्चतम कमीशन्ड रैंक का नाम है :

Options :

40503622907. एडमिरल

40503622908. चीफ मार्शल

40503622909. जनरल

40503622910. विंग कमांडर

Question Number : 66 Question Id : 4050366300 Question Type : MCQ Option Shuffling : Yes Display Question Number : Yes Is Question Mandatory : No Single Line Question Option : No Option Orientation : Vertical

Correct Marks : 4 Wrong Marks : 1

Washington DC is situated on the bank of river :

Options :

8/29/2020

40503622911. Potomac

40503622912. Thames

40503622913. Danube

40503622914. Nile

Question Number : 66 Question Id : 4050366300 Question Type : MCQ Option Shuffling : Yes Display Question Number : Yes Is Question Mandatory : No Single Line Question Option : No Option Orientation : Vertical

Correct Marks : 4 Wrong Marks : 1

वाशिंगटन डीसी इस नदी के किनारे पर बसा है :

Options :

40503622911. पोटामेक

40503622912. थेम्स

40503622913. डनुवे

40503622914. नाइल

Question Number : 67 Question Id : 4050366301 Question Type : MCQ Option Shuffling : Yes Display Question Number : Yes Is Question Mandatory : No Single Line Question Option : No Option Orientation : Vertical

Correct Marks : 4 Wrong Marks : 1

Babur defeated _____ in the first battle of Panipat on April 21, 1526.

Options :

8/29/2020

40503622915. Sher Shah

40503622916. Bairam Khan

40503622917. Hasan Khan

40503622918. Ibrahim Lodhi

Question Number : 67 Question Id : 4050366301 Question Type : MCQ Option Shuffling : Yes Display Question Number : Yes Is Question Mandatory : No Single Line Question Option : No Option Orientation : Vertical

Correct Marks : 4 Wrong Marks : 1

बाबर ने दिनांक 21 अप्रैल 1526 के पहले पानीपत युद्ध में _____ को हराया।

Options :

40503622915. शेर शाह

40503622916. बैराम खान

40503622917. हसन खान

40503622918. इब्राहिम लोधी

Question Number : 68 Question Id : 4050366302 Question Type : MCQ Option Shuffling : Yes Display Question Number : Yes Is Question Mandatory : No Single Line Question Option : No Option Orientation : Vertical

Correct Marks : 4 Wrong Marks : 1

The famous "C.K. Naidu" Trophy is associated with which sport ?

Options :

8/29/2020

40503622919. Cricket

40503622920. Lawn Tennis

40503622921. Badminton

40503622922. Hockey

Question Number : 68 Question Id : 4050366302 Question Type : MCQ Option Shuffling : Yes Display Question Number : Yes Is Question Mandatory : No Single Line Question Option : No Option Orientation : Vertical

Correct Marks : 4 Wrong Marks : 1

प्रसिद्ध "सी.के. नायडू ट्रॉफी" किस खेल से संबंधित है :

Options :

40503622919. क्रिकेट

40503622920. लॉन टेनिस

40503622921. बेडमिंटन

40503622922. हॉकी

Question Number : 69 Question Id : 4050366303 Question Type : MCQ Option Shuffling : Yes Display Question Number : Yes Is Question Mandatory : No Single Line Question Option : No Option Orientation : Vertical

Correct Marks : 4 Wrong Marks : 1

8/29/2020

What is the present name of the National Park which was established in 1931 with the aim to protect the wildlife of Karnataka and was named as "Venugopala Wildlife Park" ?

Options :

40503622923. Sundarban National Park

40503622924. Bandipur National Park

40503622925. Gir National Park

40503622926. Jim Corbett National Park

Question Number : 69 Question Id : 4050366303 Question Type : MCQ Option Shuffling : Yes Display Question Number : Yes Is Question Mandatory : No Single Line Question Option : No Option Orientation : Vertical

Correct Marks : 4 Wrong Marks : 1

उस राष्ट्रीय पार्क का वर्तमान नाम क्या है जिसे कर्नाटक के वन्य जीवों की रक्षा के उद्देश्य से 1931 में स्थापित किया गया था और उसका नाम "वेणुगोपाला वन्य जीव पार्क" रखा गया था ?

Options :

40503622923. सुन्दरबन राष्ट्रीय पार्क

40503622924. बंडीपुर राष्ट्रीय पार्क

40503622925. गिर राष्ट्रीय पार्क

8/29/2020

40503622926. जिम कारबेट राष्ट्रीय पार्क

Question Number : 70 Question Id : 4050366304 Question Type : MCQ Option Shuffling : Yes Display Question Number : Yes Is Question Mandatory : No Single Line Question Option : No Option Orientation : Vertical Correct Marks : 4 Wrong Marks : 1

IPL stands for :

Options :

40503622927. Indian Players League

40503622928. International Premier League

40503622929. Indian Premier League

40503622930. Indo-Pakistan League

Question Number : 70 Question Id : 4050366304 Question Type : MCQ Option Shuffling : Yes Display Question Number : Yes Is Question Mandatory : No Single Line Question Option : No Option Orientation : Vertical Correct Marks : 4 Wrong Marks : 1

आइ.पी.एल. का मतलब है :

Options :

40503622927. इंडियन प्लेयर्स लीग

40503622928. इंटरनेशनल प्रीमियर लीग

40503622929. इंडियन प्रीमियर लीग

40503622930. इंडो-पाकिस्तान लीग

Question Number : 71 Question Id : 4050366305 Question Type : MCQ Option Shuffling : Yes Display Question Number : Yes Is Question Mandatory : No Single Line Question Option : No Option Orientation : Vertical Correct Marks : 4 Wrong Marks : 1

'NITI' in NITI Ayog stands for :

Options :

40503622931. National Integration Tribunal of India

40503622932. National Index for Travel Institutions

40503622933. National Institution for Transforming India

40503622934. National Institute for Tourism in India

Question Number : 71 Question Id : 4050366305 Question Type : MCQ Option Shuffling : Yes Display Question Number : Yes Is Question Mandatory : No Single Line Question Option : No Option Orientation : Vertical Correct Marks : 4 Wrong Marks : 1

'NITI' आयोग में NITI का पुरा नाम है :

Options :

40503622931. नेशनल इंटीग्रेशन ट्रिब्यूनल ऑफ इंडिया

40503622932. नेशनल इंडेक्स फॉर ट्रेवल इंस्टिट्यूशन्स

40503622933. नेशनल इंस्टिट्यूशन फॉर ट्रांसफोर्मिंग इंडिया

40503622934. नेशनल इंस्टिट्यूट फॉर ट्यूरिज्म इन इंडिया

Question Number : 72 Question Id : 4050366306 Question Type : MCQ Option Shuffling : Yes Display Question Number : Yes Is Question Mandatory : No Single Line Question Option : No Option Orientation : Vertical

Correct Marks : 4 Wrong Marks : 1

The lowest temperature at which an oil gives sufficient vapours to form an explosive mixture with air is known as :

Options :

40503622935. Smoke Point

40503622936. Flash Point

40503622937. Explosive Point

40503622938. Acidic Flux

Question Number : 72 Question Id : 4050366306 Question Type : MCQ Option Shuffling : Yes Display Question Number : Yes Is Question Mandatory : No Single Line Question Option : No Option Orientation : Vertical

Correct Marks : 4 Wrong Marks : 1

वह न्यूनतम तापमान जिसमें तेल पर्याप्त माप देकर हवा के साथ मिलकर विस्फोटक सम्मिश्रण करता है। उसे कहते हैं :

Options :

40503622935. स्मोक पाइंट

8/29/2020

40503622936. फ्लैश पाइंट

40503622937. विस्फोटक पाइंट

40503622938. अम्लीय फ्लक्स

Question Number : 73 Question Id : 4050366307 Question Type : MCQ Option Shuffling : Yes Display Question Number : Yes Is Question Mandatory : No Single Line Question Option : No Option Orientation : Vertical

Correct Marks : 4 Wrong Marks : 1

Who is also known by the name :

“Frontier Gandhi”?

Options :

40503622939. Subhash Chandra Bose

40503622940. Jawahar Lal Nehru

40503622941. Bal Gangadhar Tilak

40503622942. Abdul Gaffar Khan

Question Number : 73 Question Id : 4050366307 Question Type : MCQ Option Shuffling : Yes Display Question Number : Yes Is Question Mandatory : No Single Line Question Option : No Option Orientation : Vertical

Correct Marks : 4 Wrong Marks : 1

फ्रंटियर गांधी के नाम से किसे जाना जाता है?

Options :

40503622939. सुभाष चंद्र बोस

8/29/2020

40503622940. जवाहर लाल नेहरू

40503622941. बाल गंगाधर तिलक

40503622942. अब्दुल गफ्फार खान

Question Number : 74 Question Id : 4050366308 Question Type : MCQ Option Shuffling : Yes Display Question Number : Yes Is Question Mandatory : No Single Line Question Option : No Option Orientation : Vertical

Correct Marks : 4 Wrong Marks : 1

Two smallest continents of the World are :

Options :

40503622943. Australia & Antarctica

40503622944. Antarctica & Europe

40503622945. Australia & Europe

40503622946. Australia & South America

Question Number : 74 Question Id : 4050366308 Question Type : MCQ Option Shuffling : Yes Display Question Number : Yes Is Question Mandatory : No Single Line Question Option : No Option Orientation : Vertical

Correct Marks : 4 Wrong Marks : 1

संसार के दो सबसे छोटे माहद्वीप :

Options :

40503622943. आस्ट्रेलिया एवं अंटार्टिका

40503622944. अंटार्टिका एवं यूरोप

40503622945. आस्ट्रेलिया एवं यूरोप

40503622946. आस्ट्रेलिया एवं दक्षिण अमेरिका

Question Number : 75 Question Id : 4050366309 Question Type : MCQ Option Shuffling : Yes Display Question Number : Yes Is Question Mandatory : No Single Line Question Option : No Option Orientation : Vertical Correct Marks : 4 Wrong Marks : 1

Who was popularly known as the 'Lady with the Lamp' ?

Options :

40503622947. Indira Gandhi

40503622948. Queen Elizabeth

40503622949. Florence Nightingale

40503622950. Mother Teresa

Question Number : 75 Question Id : 4050366309 Question Type : MCQ Option Shuffling : Yes Display Question Number : Yes Is Question Mandatory : No Single Line Question Option : No Option Orientation : Vertical Correct Marks : 4 Wrong Marks : 1

एक "लेडी विद दी लैंप" से कौन विख्यात है?

Options :

40503622947. इंदिरा गांधी

40503622948. रानी इलेजाबेथ

40503622949. फ्लोरेंस नाइटिंगेल

40503622950. मदर टेरेसा

Question Number : 76 Question Id : 4050366310 Question Type : MCQ Option Shuffling : Yes Display Question Number : Yes Is Question Mandatory : No Single Line Question Option : No Option Orientation : Vertical

Correct Marks : 4 Wrong Marks : 1

The two largest denomination notes demonetized on 8 November 2016 in India were :

Options :

40503622951. 100 & 500

40503622952. 500 & 2000

40503622953. 500 & 1000

40503622954. 50 & 100

Question Number : 76 Question Id : 4050366310 Question Type : MCQ Option Shuffling : Yes Display Question Number : Yes Is Question Mandatory : No Single Line Question Option : No Option Orientation : Vertical

Correct Marks : 4 Wrong Marks : 1

भारत में 8 नवम्बर 2016 को दो सबसे बड़े मूल्यवर्ग के नोटों की नोटबंदी की गई :

Options :

40503622951. 100 एवं 500

8/29/2020

40503622952. 500 एवं 2000

40503622953. 500 एवं 1000

40503622954. 50 एवं 100

Question Number : 77 Question Id : 4050366311 Question Type : MCQ Option Shuffling : Yes Display Question Number : Yes Is Question Mandatory : No Single Line Question Option : No Option Orientation : Vertical Correct Marks : 4 Wrong Marks : 1

'Higgs Boson' is also known as the :

Options :

40503622955. Sand Particle

40503622956. God Particle

40503622957. Electron

40503622958. Neutron

Question Number : 77 Question Id : 4050366311 Question Type : MCQ Option Shuffling : Yes Display Question Number : Yes Is Question Mandatory : No Single Line Question Option : No Option Orientation : Vertical Correct Marks : 4 Wrong Marks : 1

'हिग्गस बोसोन' को इस नाम से भी जाना जाता है :

Options :

40503622955. रेत कण

40503622956. गॉड कण

40503622957. इलेक्ट्रॉन

40503622958. न्यूट्रॉन

Question Number : 78 Question Id : 4050366312 Question Type : MCQ Option Shuffling : Yes Display Question Number : Yes Is Question Mandatory : No Single Line Question Option : No Option Orientation : Vertical Correct Marks : 4 Wrong Marks : 1

'The God of Small Things' is written by :

Options :

40503622959. Uma Shankar Joshi

40503622960. Taslima Nasreen

40503622961. Margret Thatcher

40503622962. Arundhati Roy

Question Number : 78 Question Id : 4050366312 Question Type : MCQ Option Shuffling : Yes Display Question Number : Yes Is Question Mandatory : No Single Line Question Option : No Option Orientation : Vertical Correct Marks : 4 Wrong Marks : 1

“गॉड ऑफ स्माल थिंगस” किसने लिखी है?

Options :

40503622959. उमा शंकर जोशी

40503622960. तस्लीमा नसरीन

8/29/2020

40503622961. मारग्रेट थैचर

40503622962. अरुंधती रॉय

Question Number : 79 Question Id : 4050366313 Question Type : MCQ Option Shuffling : Yes Display Question Number : Yes Is Question Mandatory : No Single Line Question Option : No Option Orientation : Vertical Correct Marks : 4 Wrong Marks : 1

Which city is known as "Gateway of India" ?

Options :

40503622963. Delhi

40503622964. Goa

40503622965. Mumbai

40503622966. Hyderabad

Question Number : 79 Question Id : 4050366313 Question Type : MCQ Option Shuffling : Yes Display Question Number : Yes Is Question Mandatory : No Single Line Question Option : No Option Orientation : Vertical Correct Marks : 4 Wrong Marks : 1

किस शहर को "गेटवे ऑफ इंडिया" कहा जाता है ?

Options :

40503622963. दिल्ली

40503622964. गोवा

40503622965. मुंबई

40503622966. हैदराबाद

Question Number : 80 Question Id : 4050366314 Question Type : MCQ Option Shuffling : Yes Display Question Number : Yes Is Question Mandatory : No Single Line Question Option : No Option Orientation : Vertical Correct Marks : 4 Wrong Marks : 1

Which is the largest planet in our solar system ?

Options :

40503622967. Earth

40503622968. Saturn

40503622969. Pluto

40503622970. Jupiter

Question Number : 80 Question Id : 4050366314 Question Type : MCQ Option Shuffling : Yes Display Question Number : Yes Is Question Mandatory : No Single Line Question Option : No Option Orientation : Vertical Correct Marks : 4 Wrong Marks : 1

हमारे सौर मंडल में सबसे बड़ा ग्रह कौन सा है ?

Options :

40503622967. पृथ्वी

40503622968. शनि

40503622969. प्लूटो

40503622970. बृहस्पति

Question Number : 81 Question Id : 4050366315 Question Type : MCQ Option Shuffling : Yes Display Question Number : Yes Is Question Mandatory : No Single Line Question Option : No Option Orientation : Vertical Correct Marks : 4 Wrong Marks : 1

Who won the "Women Singles" title in the U.S. Open Tennis Tournament 2018 :

Options :

40503622971. Serena Williams

40503622972. Anastasija Sevastova

40503622973. Naomi Oska

40503622974. Elena Vesnina

Question Number : 81 Question Id : 4050366315 Question Type : MCQ Option Shuffling : Yes Display Question Number : Yes Is Question Mandatory : No Single Line Question Option : No Option Orientation : Vertical Correct Marks : 4 Wrong Marks : 1

यू एस ओमन टेनिस टूर्नामेंट 2018 में 'महिला सिंगल्स' का खिताब किसने जीता था ?

Options :

40503622971. सेरेना विलियम्स

40503622972. अनास्टासिजा सेवास्टोवा

40503622973. नओमी ओसाका

40503622974. इलेना वेस्निया

Question Number : 82 Question Id : 4050366316 Question Type : MCQ Option Shuffling : Yes Display Question Number : Yes Is Question Mandatory : No Single Line Question Option : No Option Orientation : Vertical Correct Marks : 4 Wrong Marks : 1

Who amongst the following was the first woman chief - minister of U.P. State ?

Options :

40503622975. Mayawati

40503622976. Sucheta Kriplani

40503622977. Sarojini Naidu

40503622978. Kiran Bedi

Question Number : 82 Question Id : 4050366316 Question Type : MCQ Option Shuffling : Yes Display Question Number : Yes Is Question Mandatory : No Single Line Question Option : No Option Orientation : Vertical Correct Marks : 4 Wrong Marks : 1

निम्नलिखित में से उत्तर प्रदेश की पहली महिला मुख्य मंत्री कौन रही थी ?

Options :

40503622975. मायावती

40503622976. सुचेटा कृपलानी

8/29/2020

40503622977. सरोजिनी नायडू

40503622978. किरण बेदी

Question Number : 83 Question Id : 4050366317 Question Type : MCQ Option Shuffling : Yes Display Question Number : Yes Is Question Mandatory : No Single Line Question Option : No Option Orientation : Vertical Correct Marks : 4 Wrong Marks : 1

Which is the capital of South Korea ?

Options :

40503622979. Seoul

40503622980. Pyong Yang

40503622981. Hong Kong

40503622982. Dublin

Question Number : 83 Question Id : 4050366317 Question Type : MCQ Option Shuffling : Yes Display Question Number : Yes Is Question Mandatory : No Single Line Question Option : No Option Orientation : Vertical Correct Marks : 4 Wrong Marks : 1

दक्षिण कोरिया की राजधानी ?

Options :

40503622979. सियोल

40503622980. प्यांग यांग

40503622981. हांग कांग

40503622982. डबलिन

Question Number : 84 Question Id : 4050366318 Question Type : MCQ Option Shuffling : Yes Display Question Number : Yes Is Question Mandatory : No Single Line Question Option : No Option Orientation : Vertical

Correct Marks : 4 Wrong Marks : 1

Which is the device used to detect and measure small electric current in a circuit ?

Options :

40503622983. Galvanometer

40503622984. Thermometer

40503622985. Transformer

40503622986. Electromagnetic Induction

Question Number : 84 Question Id : 4050366318 Question Type : MCQ Option Shuffling : Yes Display Question Number : Yes Is Question Mandatory : No Single Line Question Option : No Option Orientation : Vertical

Correct Marks : 4 Wrong Marks : 1

वह कौन सा उपकरण है जो एक सर्किट में छोटे इलेक्ट्रिक करंट का पता लगाने एवं मापने के काम में आता है ?

Options :

40503622983. गलवानोमीटर

40503622984. थर्मोमीटर

8/29/2020

40503622985. ट्रांसफारमर

40503622986. इलेक्ट्रोमैग्नेटिक इंडक्शन

Question Number : 85 Question Id : 4050366319 Question Type : MCQ Option Shuffling : Yes Display Question Number : Yes Is Question Mandatory : No Single Line Question Option : No Option Orientation : Vertical Correct Marks : 4 Wrong Marks : 1

Which part of our body gets affected by Tuberculosis ?

Options :

40503622987. Liver

40503622988. Blood

40503622989. Lungs

40503622990. Eyes

Question Number : 85 Question Id : 4050366319 Question Type : MCQ Option Shuffling : Yes Display Question Number : Yes Is Question Mandatory : No Single Line Question Option : No Option Orientation : Vertical Correct Marks : 4 Wrong Marks : 1

टी.बी. से हमारे शरीर का कौन सा अंग प्रभावित होता है?

Options :

40503622987. यकृत

40503622988. रक्त

40503622989. फेफडे

40503622990. आँखें

Question Number : 86 Question Id : 4050366320 Question Type : MCQ Option Shuffling : Yes Display Question Number : Yes Is Question Mandatory : No Single Line Question Option : No Option Orientation : Vertical

Correct Marks : 4 Wrong Marks : 1

Identify the communication service founded in 2009 by Jan Koum and Brian Acton who were former employees of Yahoo and was acquired by Facebook in 2014.

Options :

40503622991. Twitter

40503622992. Instagram

40503622993. Hangout

40503622994. Whatsapp

Question Number : 86 Question Id : 4050366320 Question Type : MCQ Option Shuffling : Yes Display Question Number : Yes Is Question Mandatory : No Single Line Question Option : No Option Orientation : Vertical

Correct Marks : 4 Wrong Marks : 1

8/29/2020

जॉन कौम एवं ब्रायन एक्टन द्वारा 2009 पाई गई दूरसंचार सेवा की पहचान करें जो पूर्व में याहू के कर्मचारी थे जिसे 2014 में फेसबुक ने अधिग्रहित किया।

Options :

40503622991. ट्विटर

40503622992. इंस्टाग्राम

40503622993. हैगआऊट

40503622994. वट्सएप्प

Question Number : 87 Question Id : 4050366321 Question Type : MCQ Option Shuffling : Yes Display Question Number : Yes Is Question Mandatory : No Single Line Question Option : No Option Orientation : Vertical Correct Marks : 4 Wrong Marks : 1

Who is the mother of "Mahatma Gandhi" ?

Options :

40503622995. Kasturba

40503622996. Putlibai

40503622997. Archana Gandhi

40503622998. Supriya Gandhi

Question Number : 87 Question Id : 4050366321 Question Type : MCQ Option Shuffling : Yes Display Question Number : Yes Is Question Mandatory : No Single Line Question Option : No Option Orientation : Vertical

8/29/2020

Correct Marks : 4 Wrong Marks : 1

“महात्मा गांधी” की माता कौन थी ?

Options :

40503622995. कस्तूरबा

40503622996. पुतलीबाई

40503622997. अर्चना गांधी

40503622998. सुप्रिया गांधी

Question Number : 88 Question Id : 4050366322 Question Type : MCQ Option Shuffling : Yes Display Question Number : Yes Is Question Mandatory : No Single Line Question Option : No Option Orientation : Vertical

Correct Marks : 4 Wrong Marks : 1

Which state in India has the lowest literacy rate ?

Options :

40503622999. Kerala

40503623000. Punjab

40503623001. Assam

40503623002. Bihar

Question Number : 88 Question Id : 4050366322 Question Type : MCQ Option Shuffling : Yes Display Question Number : Yes Is Question Mandatory : No Single Line Question Option : No Option Orientation : Vertical

Correct Marks : 4 Wrong Marks : 1

8/29/2020

भारत के किस राज्य में सबसे कम साक्षरता दर है?

Options :

40503622999. केरल

40503623000. पंजाब

40503623001. आसाम

40503623002. बिहार

Question Number : 89 Question Id : 4050366323 Question Type : MCQ Option Shuffling : Yes Display Question Number : Yes Is Question Mandatory : No Single Line Question Option : No Option Orientation : Vertical

Correct Marks : 4 Wrong Marks : 1

Which was the first living creature sent in space ?

Options :

40503623003. Rat

40503623004. Monkey

40503623005. Cat

40503623006. Dog

Question Number : 89 Question Id : 4050366323 Question Type : MCQ Option Shuffling : Yes Display Question Number : Yes Is Question Mandatory : No Single Line Question Option : No Option Orientation : Vertical

Correct Marks : 4 Wrong Marks : 1

8/29/2020

अंतरिक्ष में भेजे गए पहले जीवित जीव कौन था :

Options :

40503623003. चूहा

40503623004. बंदर

40503623005. बिल्ली

40503623006. कुत्ता

Question Number : 90 Question Id : 4050366324 Question Type : MCQ Option Shuffling : Yes Display Question Number : Yes Is Question Mandatory : No Single Line Question Option : No Option Orientation : Vertical

Correct Marks : 4 Wrong Marks : 1

What do Dr. C.V. Raman, Dr. Zakir Hussain, Satyajit Roy and Mother Teresa have in common ?

Options :

40503623007. Pulitzer Prize

40503623008. Magsaysay Award

40503623009. Nobel Prize

40503623010. Bharat Ratna

Question Number : 90 Question Id : 4050366324 Question Type : MCQ Option Shuffling : Yes Display Question Number : Yes Is Question Mandatory : No Single Line Question Option : No Option Orientation : Vertical

Correct Marks : 4 Wrong Marks : 1

8/29/2020

डॉ. सी.वी. रमन, डॉ. जाकिर हुसैन, सत्यजीत रॉय एवं
मदर टेरेसा में क्या सामान्य है?

Options :

40503623007. पुल्लिजर पुरस्कार

40503623008. मगसेसे अवार्ड

40503623009. नोबल पुरस्कार

40503623010. भारत रत्न

English language

Section Id :	405036224
Section Number :	4
Section type :	Online
Mandatory or Optional :	Mandatory
Number of Questions :	11
Number of Questions to be attempted :	11
Section Marks :	240
Display Number Panel :	Yes
Group All Questions :	Yes
Mark As Answered Required? :	Yes
Sub-Section Number :	1
Sub-Section Id :	405036485
Question Shuffling Allowed :	Yes

Question Id : 4050366325 Question Type : COMPREHENSION Sub Question Shuffling Allowed : Yes Group Comprehension Questions : No

Question Numbers : (91 to 95)

8/29/2020

Question Label : Comprehension

Directions : Each of these questions consists of a sentence which is divided into four parts numbered (1) to (4). Only one part in each sentence is not acceptable, in standard written English. Identify that part which contains an error.

Sub questions

Question Number : 91 Question Id : 4050366326 Question Type : MCQ Option Shuffling : Yes Display Question Number : Yes Is Question Mandatory : No Single Line Question Option : No Option Orientation : Vertical

Correct Marks : 4 Wrong Marks : 1

Directions : Each of these questions consists of a sentence which is divided into four parts numbered (1) to (4). Only one part in each sentence is not acceptable, in standard written English. Identify that part which contains an error.

Options :

40503623011. I can show you

40503623012. The place where the accident occurred

40503623013. and caused him

40503623014. to lost his right eye

Question Number : 92 Question Id : 4050366327 Question Type : MCQ Option Shuffling : Yes Display Question Number : Yes Is Question Mandatory : No Single Line Question Option : No Option Orientation : Vertical

Correct Marks : 4 Wrong Marks : 1

Directions : Each of these questions consists of a sentence which is divided into four parts numbered (1) to (4). Only one part in each sentence is not acceptable, in standard written English. Identify that part which contains an error.

Options :

40503623015. Monika and Leena

40503623016. is going

40503623017. to the book fair

40503623018. today evening

Question Number : 93 Question Id : 4050366328 Question Type : MCQ Option Shuffling : Yes Display Question Number : Yes Is Question Mandatory : No Single Line Question Option : No Option Orientation : Vertical

Correct Marks : 4 Wrong Marks : 1

Directions : Each of these questions consists of a sentence which is divided into four parts numbered (1) to (4). Only one part in each sentence is not acceptable, in standard written English. Identify that part which contains an error.

Options :

40503623019. It is a misfortune

40503623020. That you could not do anything

40503623021. To help him

40503623022. When he were in trouble

Question Number : 94 Question Id : 4050366329 Question Type : MCQ Option Shuffling : Yes Display Question Number : Yes Is Question Mandatory : No Single Line Question Option : No Option Orientation : Vertical

Correct Marks : 4 Wrong Marks : 1

Directions : Each of these questions consists of a sentence which is divided into four parts numbered (1) to (4). Only one part in each sentence is not acceptable, in standard written English. Identify that part which contains an error.

8/29/2020

Options :

40503623023. I know you helped him

40503623024. Yet I am not angry

40503623025. With you

40503623026. For he is yours friend

Question Number : 95 Question Id : 4050366330 Question Type : MCQ Option Shuffling : Yes Display Question Number : Yes Is Question Mandatory : No Single Line Question Option : No Option Orientation : Vertical

Correct Marks : 4 Wrong Marks : 1

Directions : Each of these questions consists of a sentence which is divided into four parts numbered (1) to (4). Only one part in each sentence is not acceptable, in standard written English. Identify that part which contains an error.

Options :

40503623027. pants of his father

40503623028. was cut short

40503623029. by two inches

40503623030. so that he could use them

Question Id : 4050366325 Question Type : COMPREHENSION Sub Question Shuffling Allowed : Yes Group Comprehension Questions : No

Question Numbers : (91 to 95)

Question Label : Comprehension

Directions : Each of these questions consists of a sentence which is divided into four parts numbered (1) to (4). Only one part in each sentence is not acceptable, in standard written English. Identify that part which contains an error.

Sub questions

Question Number : 91 Question Id : 4050366326 Question Type : MCQ Option Shuffling : Yes Display Question Number : Yes Is Question Mandatory : No Single Line Question Option : No Option Orientation : Vertical

Correct Marks : 4 Wrong Marks : 1

Directions : Each of these questions consists of a sentence which is divided into four parts numbered (1) to (4). Only one part in each sentence is not acceptable, in standard written English. Identify that part which contains an error.

Options :

40503623011. I can show you
40503623012. The place where the accident occurred
40503623013. and caused him
40503623014. to lost his right eye

Question Number : 92 Question Id : 4050366327 Question Type : MCQ Option Shuffling : Yes Display Question Number : Yes Is Question Mandatory : No Single Line Question Option : No Option Orientation : Vertical

Correct Marks : 4 Wrong Marks : 1

Directions : Each of these questions consists of a sentence which is divided into four parts numbered (1) to (4). Only one part in each sentence is not acceptable, in standard written English. Identify that part which contains an error.

Options :

40503623015. Monika and Leena

8/29/2020

40503623016. is going

40503623017. to the book fair

40503623018. today evening

Question Number : 93 Question Id : 4050366328 Question Type : MCQ Option Shuffling : Yes Display Question Number : Yes Is Question Mandatory : No Single Line Question Option : No Option Orientation : Vertical

Correct Marks : 4 Wrong Marks : 1

Directions : Each of these questions consists of a sentence which is divided into four parts numbered (1) to (4). Only one part in each sentence is not acceptable, in standard written English. Identify that part which contains an error.

Options :

40503623019. It is a misfortune

40503623020. That you could not do anything

40503623021. To help him

40503623022. When he were in trouble

Question Number : 94 Question Id : 4050366329 Question Type : MCQ Option Shuffling : Yes Display Question Number : Yes Is Question Mandatory : No Single Line Question Option : No Option Orientation : Vertical

Correct Marks : 4 Wrong Marks : 1

Directions : Each of these questions consists of a sentence which is divided into four parts numbered (1) to (4). Only one part in each sentence is not acceptable, in standard written English. Identify that part which contains an error.

Options :

8/29/2020

40503623023. I know you helped him

40503623024. Yet I am not angry

40503623025. With you

40503623026. For he is yours friend

Question Number : 95 Question Id : 4050366330 Question Type : MCQ Option Shuffling : Yes Display Question Number : Yes Is Question Mandatory : No Single Line Question Option : No Option Orientation : Vertical

Correct Marks : 4 Wrong Marks : 1

Directions : Each of these questions consists of a sentence which is divided into four parts numbered (1) to (4). Only one part in each sentence is not acceptable, in standard written English. Identify that part which contains an error.

Options :

40503623027. pants of his father

40503623028. was cut short

40503623029. by two inches

40503623030. so that he could use them

Sub-Section Number :

2

Sub-Section Id :

405036486

Question Shuffling Allowed :

Yes

Question Id : 4050366331 Question Type : COMPREHENSION Sub Question Shuffling Allowed : Yes Group Comprehension Questions : No

Question Numbers : (96 to 100)

8/29/2020

Question Label : Comprehension

Directions : In each of the following questions, out of the given alternatives, choose the one which is nearest in meaning to the underlined word in the sentence.

Sub questions

Question Number : 96 Question Id : 4050366332 Question Type : MCQ Option Shuffling : Yes Display Question Number : Yes Is Question Mandatory : No Single Line Question Option : No Option Orientation : Vertical

Correct Marks : 4 Wrong Marks : 1

Your master will like you if you are diligent.

Options :

40503623031. Conscientious

40503623032. Obedient

40503623033. Meticulous

40503623034. Hard working

Question Number : 97 Question Id : 4050366333 Question Type : MCQ Option Shuffling : Yes Display Question Number : Yes Is Question Mandatory : No Single Line Question Option : No Option Orientation : Vertical

Correct Marks : 4 Wrong Marks : 1

Govt. ID cards are the only way to authenticate ones identity in airports.

Options :

40503623035. Validate

40503623036. Displayed

40503623037. Supporting

8/29/2020

40503623038. **Immigrate**

Question Number : 98 Question Id : 4050366334 Question Type : MCQ Option Shuffling : Yes Display Question Number : Yes Is Question Mandatory : No Single Line Question Option : No Option Orientation : Vertical Correct Marks : 4 Wrong Marks : 1

He had the nerve to suggest that I was cheating.

Options :

40503623039. **strength**

40503623040. **capacity**

40503623041. **audacity**

40503623042. **courage**

Question Number : 99 Question Id : 4050366335 Question Type : MCQ Option Shuffling : Yes Display Question Number : Yes Is Question Mandatory : No Single Line Question Option : No Option Orientation : Vertical Correct Marks : 4 Wrong Marks : 1

Nisha looked beautiful and elegant, in a classy pink dress, she wore for her sister's wedding.

Options :

40503623043. **Majestic**

40503623044. **Important**

40503623045. **Simple**

40503623046. **Huge**

Question Number : 100 Question Id : 4050366336 Question Type : MCQ Option Shuffling : Yes Display Question Number : Yes Is Question Mandatory : No Single Line Question Option : No Option Orientation : Vertical

Correct Marks : 4 Wrong Marks : 1

We Cherish the good memories of the festive season.

Options :

40503623047. Treasure

40503623048. Cheer

40503623049. Harmonise

40503623050. Praise

Question Id : 4050366331 Question Type : COMPREHENSION Sub Question Shuffling Allowed : Yes Group Comprehension Questions : No

Question Numbers : (96 to 100)

Question Label : Comprehension

Directions : In each of the following questions, out of the given alternatives, choose the one which is nearest in meaning to the underlined word in the sentence.

Sub questions

Question Number : 96 Question Id : 4050366332 Question Type : MCQ Option Shuffling : Yes Display Question Number : Yes Is Question Mandatory : No Single Line Question Option : No Option Orientation : Vertical

Correct Marks : 4 Wrong Marks : 1

Your master will like you if you are diligent.

Options :

40503623031. Conscientious

40503623032. Obedient

8/29/2020

40503623033. Meticulous

40503623034. Hard working

Question Number : 97 Question Id : 4050366333 Question Type : MCQ Option Shuffling : Yes Display Question Number : Yes Is Question Mandatory : No Single Line Question Option : No Option Orientation : Vertical Correct Marks : 4 Wrong Marks : 1

Govt. ID cards are the only way to authenticate ones identity in airports.

Options :

40503623035. Validate

40503623036. Displayed

40503623037. Supporting

40503623038. Immigrate

Question Number : 98 Question Id : 4050366334 Question Type : MCQ Option Shuffling : Yes Display Question Number : Yes Is Question Mandatory : No Single Line Question Option : No Option Orientation : Vertical Correct Marks : 4 Wrong Marks : 1

He had the nerve to suggest that I was cheating.

Options :

40503623039. strength

40503623040. capacity

40503623041. audacity

40503623042. **courage**

Question Number : 99 Question Id : 4050366335 Question Type : MCQ Option Shuffling : Yes Display Question Number : Yes Is Question Mandatory : No Single Line Question Option : No Option Orientation : Vertical

Correct Marks : 4 Wrong Marks : 1

Nisha looked beautiful and elegant, in a classy pink dress, she wore for her sister's wedding.

Options :

40503623043. **Majestic**

40503623044. **Important**

40503623045. **Simple**

40503623046. **Huge**

Question Number : 100 Question Id : 4050366336 Question Type : MCQ Option Shuffling : Yes Display Question Number : Yes Is Question Mandatory : No Single Line Question Option : No Option Orientation : Vertical

Correct Marks : 4 Wrong Marks : 1

We Cherish the good memories of the festive season.

Options :

40503623047. **Treasure**

40503623048. **Cheer**

40503623049. **Harmonise**

40503623050. **Praise**

8/29/2020

Sub-Section Number : 3
Sub-Section Id : 405036487
Question Shuffling Allowed : Yes

Question Id : 4050366337 Question Type : COMPREHENSION Sub Question Shuffling Allowed : Yes Group Comprehension Questions : No

Question Numbers : (101 to 105)

Question Label : Comprehension

Directions : In each of the following questions, out of the given alternatives, choose the one which is most nearly opposite in meaning to the underlined word.

Sub questions

Question Number : 101 Question Id : 4050366338 Question Type : MCQ Option Shuffling : Yes Display Question Number : Yes Is Question Mandatory : No Single Line Question Option : No Option Orientation : Vertical

Correct Marks : 4 Wrong Marks : 1

At his success in examination he felt elated.

Options :

40503623051. excellent

40503623052. dejected

40503623053. resting

40503623054. jubilant

Question Number : 102 Question Id : 4050366339 Question Type : MCQ Option Shuffling : Yes Display Question Number : Yes Is Question Mandatory : No Single Line Question Option : No Option Orientation : Vertical

Correct Marks : 4 Wrong Marks : 1

Complicated instructions in a question paper leads to confusion.

Options :

8/29/2020

40503623055. Complex

40503623056. Slow

40503623057. Tough

40503623058. Simple

Question Number : 103 Question Id : 4050366340 Question Type : MCQ Option Shuffling : Yes Display Question Number : Yes Is Question Mandatory : No Single Line Question Option : No Option Orientation : Vertical

Correct Marks : 4 Wrong Marks : 1

Indian Institute of Management is an autonomous, organization, responsible for the finance, exams and administration.

Options :

40503623059. Magnanimous

40503623060. Ambiguous

40503623061. Operational

40503623062. Dependent

Question Number : 104 Question Id : 4050366341 Question Type : MCQ Option Shuffling : Yes Display Question Number : Yes Is Question Mandatory : No Single Line Question Option : No Option Orientation : Vertical

Correct Marks : 4 Wrong Marks : 1

A character without a blemish is a virtue of a leader.

Options :

40503623063. shame

40503623064. disgrace

40503623065. decoration

40503623066. blot

Question Number : 105 Question Id : 4050366342 Question Type : MCQ Option Shuffling : Yes Display Question Number : Yes Is Question Mandatory : No Single Line Question Option : No Option Orientation : Vertical

Correct Marks : 4 Wrong Marks : 1

The sweet shop in M block market serves delicious 'desserts'.

Options :

40503623067. Tasteful

40503623068. Appetizing

40503623069. Distasteful

40503623070. Appealing

Question Id : 4050366337 Question Type : COMPREHENSION Sub Question Shuffling Allowed : Yes Group Comprehension Questions : No

Question Numbers : (101 to 105)

Question Label : Comprehension

Directions : In each of the following questions, out of the given alternatives, choose the one which is most nearly opposite in meaning to the underlined word.

Sub questions

Question Number : 101 Question Id : 4050366338 Question Type : MCQ Option Shuffling : Yes Display Question Number : Yes Is

8/29/2020

Question Mandatory : No Single Line Question Option : No Option Orientation : Vertical

Correct Marks : 4 Wrong Marks : 1

At his success in examination he felt elated .

Options :

40503623051. excellent

40503623052. dejected

40503623053. resting

40503623054. jubilant

Question Number : 102 Question Id : 4050366339 Question Type : MCQ Option Shuffling : Yes Display Question Number : Yes Is

Question Mandatory : No Single Line Question Option : No Option Orientation : Vertical

Correct Marks : 4 Wrong Marks : 1

Complicated instructions in a question paper leads to confusion.

Options :

40503623055. Complex

40503623056. Slow

40503623057. Tough

40503623058. Simple

Question Number : 103 Question Id : 4050366340 Question Type : MCQ Option Shuffling : Yes Display Question Number : Yes Is

Question Mandatory : No Single Line Question Option : No Option Orientation : Vertical

Correct Marks : 4 Wrong Marks : 1

8/29/2020

Indian Institute of Management is an autonomous, organization, responsible for the finance, exams and administration.

Options :

40503623059. Magnanimous

40503623060. Ambiguous

40503623061. Operational

40503623062. Dependent

Question Number : 104 Question Id : 4050366341 Question Type : MCQ Option Shuffling : Yes Display Question Number : Yes Is Question Mandatory : No Single Line Question Option : No Option Orientation : Vertical

Correct Marks : 4 Wrong Marks : 1

A character without a blemish is a virtue of a leader.

Options :

40503623063. shame

40503623064. disgrace

40503623065. decoration

40503623066. blot

Question Number : 105 Question Id : 4050366342 Question Type : MCQ Option Shuffling : Yes Display Question Number : Yes Is Question Mandatory : No Single Line Question Option : No Option Orientation : Vertical

Correct Marks : 4 Wrong Marks : 1

The sweet shop in M block market serves delicious 'desserts'.

8/29/2020

Options :

40503623067. **Tasteful**

40503623068. **Appetizing**

40503623069. **Distasteful**

40503623070. **Appealing**

Sub-Section Number :

4

Sub-Section Id :

405036488

Question Shuffling Allowed :

Yes

Question Id : 4050366343 Question Type : COMPREHENSION Sub Question Shuffling Allowed : Yes Group Comprehension Questions : No

Question Numbers : (106 to 110)

Question Label : Comprehension

Directions for : In each of the following questions, choose the option which can be substituted for the given words/sentence.

Sub questions

Question Number : 106 Question Id : 4050366344 Question Type : MCQ Option Shuffling : Yes Display Question Number : Yes Is

Question Mandatory : No Single Line Question Option : No Option Orientation : Vertical

Correct Marks : 4 Wrong Marks : 1

A person, who takes no intoxicating drugs or drinks;

Options :

40503623071. **Truant**

40503623072. **Teetotaller**

8/29/2020

40503623073. Topper

40503623074. Tyrant

Question Number : 107 Question Id : 4050366345 Question Type : MCQ Option Shuffling : Yes Display Question Number : Yes Is Question Mandatory : No Single Line Question Option : No Option Orientation : Vertical

Correct Marks : 4 Wrong Marks : 1

Stealing from writing of others.

Options :

40503623075. Reproducing

40503623076. Reframing

40503623077. Copying

40503623078. Plagiarism

Question Number : 108 Question Id : 4050366346 Question Type : MCQ Option Shuffling : Yes Display Question Number : Yes Is Question Mandatory : No Single Line Question Option : No Option Orientation : Vertical

Correct Marks : 4 Wrong Marks : 1

Yearly celebration of a date as an event.

Options :

40503623079. Centenary

40503623080. Jubilee

40503623081. Anniversary

8/29/2020

40503623082. Birthday

Question Number : 109 Question Id : 4050366347 Question Type : MCQ Option Shuffling : Yes Display Question Number : Yes Is Question Mandatory : No Single Line Question Option : No Option Orientation : Vertical Correct Marks : 4 Wrong Marks : 1

A person pretending to be somebody he is not.

Options :

40503623083. Imposter

40503623084. Liar

40503623085. Rogue

40503623086. Magician

Question Number : 110 Question Id : 4050366348 Question Type : MCQ Option Shuffling : Yes Display Question Number : Yes Is Question Mandatory : No Single Line Question Option : No Option Orientation : Vertical Correct Marks : 4 Wrong Marks : 1

A person, who dies for a noble cause;

Options :

40503623087. Mercenary

40503623088. Misanthrope

40503623089. Martyr

40503623090. Namesake

Question Id : 4050366343 Question Type : COMPREHENSION Sub Question Shuffling Allowed : Yes Group Comprehension Questions : No

Question Numbers : (106 to 110)

Question Label : Comprehension

Directions for : In each of the following questions, choose the option which can be substituted for the given words/sentence.

Sub questions

Question Number : 106 Question Id : 4050366344 Question Type : MCQ Option Shuffling : Yes Display Question Number : Yes Is Question Mandatory : No Single Line Question Option : No Option Orientation : Vertical

Correct Marks : 4 Wrong Marks : 1

A person, who takes no intoxicating drugs or drinks;

Options :

40503623071. Truant

40503623072. Teetotaller

40503623073. Topper

40503623074. Tyrant

Question Number : 107 Question Id : 4050366345 Question Type : MCQ Option Shuffling : Yes Display Question Number : Yes Is Question Mandatory : No Single Line Question Option : No Option Orientation : Vertical

Correct Marks : 4 Wrong Marks : 1

Stealing from writing of others.

Options :

40503623075. Reproducing

40503623076. Reframing

40503623077. Copying

40503623078. Plagiarism

Question Number : 108 Question Id : 4050366346 Question Type : MCQ Option Shuffling : Yes Display Question Number : Yes Is Question Mandatory : No Single Line Question Option : No Option Orientation : Vertical Correct Marks : 4 Wrong Marks : 1

Yearly celebration of a date as an event.

Options :

40503623079. Centenary

40503623080. Jubilee

40503623081. Anniversary

40503623082. Birthday

Question Number : 109 Question Id : 4050366347 Question Type : MCQ Option Shuffling : Yes Display Question Number : Yes Is Question Mandatory : No Single Line Question Option : No Option Orientation : Vertical Correct Marks : 4 Wrong Marks : 1

A person pretending to be somebody he is not.

Options :

40503623083. Imposter

40503623084. Liar

40503623085. Rogue

40503623086. Magician

Question Number : 110 Question Id : 4050366348 Question Type : MCQ Option Shuffling : Yes Display Question Number : Yes Is Question Mandatory : No Single Line Question Option : No Option Orientation : Vertical

Correct Marks : 4 Wrong Marks : 1

A person, who dies for a noble cause;

Options :

40503623087. Mercenary

40503623088. Misanthrope

40503623089. Martyr

40503623090. Namesake

Sub-Section Number : 5
Sub-Section Id : 405036489
Question Shuffling Allowed : Yes

Question Id : 4050366349 Question Type : COMPREHENSION Sub Question Shuffling Allowed : Yes Group Comprehension Questions : No

Question Numbers : (111 to 115)

Question Label : Comprehension

Directions : Choose the word/phrase nearest in meaning to the underlined part.

Sub questions

Question Number : 111 Question Id : 4050366350 Question Type : MCQ Option Shuffling : Yes Display Question Number : Yes Is Question Mandatory : No Single Line Question Option : No Option Orientation : Vertical

Correct Marks : 4 Wrong Marks : 1

8/29/2020

My colleague decided to back me up in the meeting.

Options :

40503623091. criticize

40503623092. appreciate

40503623093. support

40503623094. follow

Question Number : 112 Question Id : 4050366351 Question Type : MCQ Option Shuffling : Yes Display Question Number : Yes Is Question Mandatory : No Single Line Question Option : No Option Orientation : Vertical

Correct Marks : 4 Wrong Marks : 1

The fair and square policy of the chief minister has made him very popular in his state.

Options :

40503623095. Clever and Deceitly

40503623096. Honest

40503623097. Ambiguous

40503623098. Relevant and practical

Question Number : 113 Question Id : 4050366352 Question Type : MCQ Option Shuffling : Yes Display Question Number : Yes Is Question Mandatory : No Single Line Question Option : No Option Orientation : Vertical

Correct Marks : 4 Wrong Marks : 1

All the students turned a deaf ear to their teachers during dance party.

Options :

8/29/2020

40503623099. listened attentively
40503623100. behaved obediently
40503623101. started hooting
40503623102. did not pay attention to

Question Number : 114 Question Id : 4050366353 Question Type : MCQ Option Shuffling : Yes Display Question Number : Yes Is Question Mandatory : No Single Line Question Option : No Option Orientation : Vertical Correct Marks : 4 Wrong Marks : 1

You have to rush from pillar to post , but you have no chance of getting what you want without a bribe.

Options :

40503623103. Be very busy
40503623104. Go to post office
40503623105. Made to run around
40503623106. Stand near a pillar

Question Number : 115 Question Id : 4050366354 Question Type : MCQ Option Shuffling : Yes Display Question Number : Yes Is Question Mandatory : No Single Line Question Option : No Option Orientation : Vertical Correct Marks : 4 Wrong Marks : 1

His arrogant behaviour with others has left him high and dry .

Options :

8/29/2020

40503623107. To be penniless

40503623108. To be very sick

40503623109. To be very famous

40503623110. Isolated

Question Id : 4050366349 Question Type : COMPREHENSION Sub Question Shuffling Allowed : Yes Group Comprehension Questions : No

Question Numbers : (111 to 115)

Question Label : Comprehension

Directions : Choose the word/phrase nearest in meaning to the underlined part.

Sub questions

Question Number : 111 Question Id : 4050366350 Question Type : MCQ Option Shuffling : Yes Display Question Number : Yes Is Question Mandatory : No Single Line Question Option : No Option Orientation : Vertical

Correct Marks : 4 Wrong Marks : 1

My colleague decided to back me up in the meeting.

Options :

40503623091. criticize

40503623092. appreciate

40503623093. support

40503623094. follow

Question Number : 112 Question Id : 4050366351 Question Type : MCQ Option Shuffling : Yes Display Question Number : Yes Is

8/29/2020

Question Mandatory : No Single Line Question Option : No Option Orientation : Vertical

Correct Marks : 4 Wrong Marks : 1

The fair and square policy of the chief minister has made him very popular in his state.

Options :

40503623095. Clever and Deceitly

40503623096. Honest

40503623097. Ambiguous

40503623098. Relevant and practical

Question Number : 113 Question Id : 4050366352 Question Type : MCQ Option Shuffling : Yes Display Question Number : Yes Is

Question Mandatory : No Single Line Question Option : No Option Orientation : Vertical

Correct Marks : 4 Wrong Marks : 1

All the students turned a deaf ear to their teachers during dance party.

Options :

40503623099. listened attentively

40503623100. behaved obediently

40503623101. started hooting

40503623102. did not pay attention to

Question Number : 114 Question Id : 4050366353 Question Type : MCQ Option Shuffling : Yes Display Question Number : Yes Is

Question Mandatory : No Single Line Question Option : No Option Orientation : Vertical

Correct Marks : 4 Wrong Marks : 1

8/29/2020

You have to rush from pillar to post , but you have no chance of getting what you want without a bribe.

Options :

40503623103. Be very busy

40503623104. Go to post office

40503623105. Made to run around

40503623106. Stand near a pillar

Question Number : 115 Question Id : 4050366354 Question Type : MCQ Option Shuffling : Yes Display Question Number : Yes Is Question Mandatory : No Single Line Question Option : No Option Orientation : Vertical Correct Marks : 4 Wrong Marks : 1

His arrogant behaviour with others has left him high and dry .

Options :

40503623107. To be penniless

40503623108. To be very sick

40503623109. To be very famous

40503623110. Isolated

Sub-Section Number :

6

Sub-Section Id :

405036490

Question Shuffling Allowed :

Yes

Question Id : 4050366355 Question Type : COMPREHENSION Sub Question Shuffling Allowed : Yes Group Comprehension Questions

8/29/2020

: No

Question Numbers : (116 to 120)

Question Label : Comprehension

Directions : In the following questions, 4 words are given. One word is spelt correctly, while three words are wrongly spelt. Choose the correctly spelt word.

Sub questions

Question Number : 116 Question Id : 4050366356 Question Type : MCQ Option Shuffling : Yes Display Question Number : Yes Is

Question Mandatory : No Single Line Question Option : No Option Orientation : Vertical

Correct Marks : 4 Wrong Marks : 1

Directions : In the following questions, 4 words are given. One word is spelt correctly, while three words are wrongly spelt. Choose the correctly spelt word.

Options :

40503623111. Gaurantee

40503623112. Gurantee

40503623113. Guarantee

40503623114. Garantee

Question Number : 117 Question Id : 4050366357 Question Type : MCQ Option Shuffling : Yes Display Question Number : Yes Is

Question Mandatory : No Single Line Question Option : No Option Orientation : Vertical

Correct Marks : 4 Wrong Marks : 1

Directions : In the following questions, 4 words are given. One word is spelt correctly, while three words are wrongly spelt. Choose the correctly spelt word.

Options :

40503623115. inconvinience

40503623116. inconvenience

40503623117. inconvenience

40503623118. inconveniense

Question Number : 118 Question Id : 4050366358 Question Type : MCQ Option Shuffling : Yes Display Question Number : Yes Is Question Mandatory : No Single Line Question Option : No Option Orientation : Vertical Correct Marks : 4 Wrong Marks : 1

Directions : In the following questions, 4 words are given. One word is spelt correctly, while three words are wrongly spelt. Choose the correctly spelt word.

Options :

40503623119. Vacum

40503623120. Vaacum

40503623121. Vacuum

40503623122. Vacumm

Question Number : 119 Question Id : 4050366359 Question Type : MCQ Option Shuffling : Yes Display Question Number : Yes Is Question Mandatory : No Single Line Question Option : No Option Orientation : Vertical Correct Marks : 4 Wrong Marks : 1

Directions : In the following questions, 4 words are given. One word is spelt correctly, while three words are wrongly spelt. Choose the correctly spelt word.

Options :

40503623123. Preservarance

40503623124. Preserverence

8/29/2020

40503623125. Perseverence

40503623126. Perseverance

Question Number : 120 Question Id : 4050366360 Question Type : MCQ Option Shuffling : Yes Display Question Number : Yes Is Question Mandatory : No Single Line Question Option : No Option Orientation : Vertical

Correct Marks : 4 Wrong Marks : 1

Directions : In the following questions, 4 words are given. One word is spelt correctly, while three words are wrongly spelt. Choose the correctly spelt word.

Options :

40503623127. Receipt

40503623128. Reciept

40503623129. Raceipt

40503623130. Reecipt

Question Id : 4050366355 Question Type : COMPREHENSION Sub Question Shuffling Allowed : Yes Group Comprehension Questions : No

Question Numbers : (116 to 120)

Question Label : Comprehension

Directions : In the following questions, 4 words are given. One word is spelt correctly, while three words are wrongly spelt. Choose the correctly spelt word.

Sub questions

Question Number : 116 Question Id : 4050366356 Question Type : MCQ Option Shuffling : Yes Display Question Number : Yes Is Question Mandatory : No Single Line Question Option : No Option Orientation : Vertical

8/29/2020

Correct Marks : 4 Wrong Marks : 1

Directions : In the following questions, 4 words are given. One word is spelt correctly, while three words are wrongly spelt. Choose the correctly spelt word.

Options :

40503623111. Gaurantee

40503623112. Gurantee

40503623113. Guarantee

40503623114. Garantee

Question Number : 117 Question Id : 4050366357 Question Type : MCQ Option Shuffling : Yes Display Question Number : Yes Is Question Mandatory : No Single Line Question Option : No Option Orientation : Vertical

Correct Marks : 4 Wrong Marks : 1

Directions : In the following questions, 4 words are given. One word is spelt correctly, while three words are wrongly spelt. Choose the correctly spelt word.

Options :

40503623115. inconvinience

40503623116. inconvenience

40503623117. inconveneince

40503623118. inconveniense

Question Number : 118 Question Id : 4050366358 Question Type : MCQ Option Shuffling : Yes Display Question Number : Yes Is Question Mandatory : No Single Line Question Option : No Option Orientation : Vertical

Correct Marks : 4 Wrong Marks : 1

8/29/2020

Directions : In the following questions, 4 words are given. One word is spelt correctly, while three words are wrongly spelt. Choose the correctly spelt word.

Options :

40503623119. Vacuum

40503623120. Vaacum

40503623121. Vacuum

40503623122. Vacumm

Question Number : 119 Question Id : 4050366359 Question Type : MCQ Option Shuffling : Yes Display Question Number : Yes Is Question Mandatory : No Single Line Question Option : No Option Orientation : Vertical

Correct Marks : 4 Wrong Marks : 1

Directions : In the following questions, 4 words are given. One word is spelt correctly, while three words are wrongly spelt. Choose the correctly spelt word.

Options :

40503623123. Preservarance

40503623124. Preserverence

40503623125. Perseverence

40503623126. Perseverance

Question Number : 120 Question Id : 4050366360 Question Type : MCQ Option Shuffling : Yes Display Question Number : Yes Is Question Mandatory : No Single Line Question Option : No Option Orientation : Vertical

Correct Marks : 4 Wrong Marks : 1

8/29/2020

Directions : In the following questions, 4 words are given. One word is spelt correctly, while three words are wrongly spelt. Choose the correctly spelt word.

Options :

40503623127. Receipt

40503623128. Reciept

40503623129. Raceipt

40503623130. Reeciapt

Sub-Section Number :

7

Sub-Section Id :

405036491

Question Shuffling Allowed :

Yes

Question Id : 4050366361 Question Type : COMPREHENSION Sub Question Shuffling Allowed : Yes Group Comprehension Questions : No

Question Numbers : (121 to 125)

Question Label : Comprehension

Directions : In each of the following 4 words, one word has been spelt wrongly. Choose the wrongly spelt word.

Sub questions

Question Number : 121 Question Id : 4050366362 Question Type : MCQ Option Shuffling : Yes Display Question Number : Yes Is

Question Mandatory : No Single Line Question Option : No Option Orientation : Vertical

Correct Marks : 4 Wrong Marks : 1

Directions : In each of the following 4 words, one word has been spelt wrongly. Choose the wrongly spelt word.

Options :

40503623131. Homogenious

8/29/2020

40503623132. Honorarium

40503623133. Honourable

40503623134. Hoarding

Question Number : 122 Question Id : 4050366363 Question Type : MCQ Option Shuffling : Yes Display Question Number : Yes Is Question Mandatory : No Single Line Question Option : No Option Orientation : Vertical

Correct Marks : 4 Wrong Marks : 1

Directions : In each of the following 4 words, one word has been spelt wrongly. Choose the wrongly spelt word.

Options :

40503623135. Companion

40503623136. Campaign

40503623137. Community

40503623138. Competitive

Question Number : 123 Question Id : 4050366364 Question Type : MCQ Option Shuffling : Yes Display Question Number : Yes Is Question Mandatory : No Single Line Question Option : No Option Orientation : Vertical

Correct Marks : 4 Wrong Marks : 1

Directions : In each of the following 4 words, one word has been spelt wrongly. Choose the wrongly spelt word.

Options :

40503623139. Ballistic

40503623140. Bullock

40503623141. Bulletin

40503623142. Baloon

Question Number : 124 Question Id : 4050366365 Question Type : MCQ Option Shuffling : Yes Display Question Number : Yes Is Question Mandatory : No Single Line Question Option : No Option Orientation : Vertical

Correct Marks : 4 Wrong Marks : 1

Directions : In each of the following 4 words, one word has been spelt wrongly. Choose the wrongly spelt word.

Options :

40503623143. Passanger

40503623144. Instructor

40503623145. Conquer

40503623146. Grammer

Question Number : 125 Question Id : 4050366366 Question Type : MCQ Option Shuffling : Yes Display Question Number : Yes Is Question Mandatory : No Single Line Question Option : No Option Orientation : Vertical

Correct Marks : 4 Wrong Marks : 1

Directions : In each of the following 4 words, one word has been spelt wrongly. Choose the wrongly spelt word.

Options :

40503623147. boredom

8/29/2020

40503623148. implicit

40503623149. explicit

40503623150. bruchure

Question Id : 4050366361 Question Type : COMPREHENSION Sub Question Shuffling Allowed : Yes Group Comprehension Questions : No

Question Numbers : (121 to 125)

Question Label : Comprehension

Directions : In each of the following 4 words, one word has been spelt wrongly. Choose the wrongly spelt word.

Sub questions

Question Number : 121 Question Id : 4050366362 Question Type : MCQ Option Shuffling : Yes Display Question Number : Yes Is Question Mandatory : No Single Line Question Option : No Option Orientation : Vertical

Correct Marks : 4 Wrong Marks : 1

Directions : In each of the following 4 words, one word has been spelt wrongly. Choose the wrongly spelt word.

Options :

40503623131. Homogenious

40503623132. Honorarium

40503623133. Honourable

40503623134. Hoarding

8/29/2020

Question Number : 122 Question Id : 4050366363 Question Type : MCQ Option Shuffling : Yes Display Question Number : Yes Is Question Mandatory : No Single Line Question Option : No Option Orientation : Vertical

Correct Marks : 4 Wrong Marks : 1

Directions : In each of the following 4 words, one word has been spelt wrongly. Choose the wrongly spelt word.

Options :

40503623135. Companion

40503623136. Campaign

40503623137. Community

40503623138. Competitive

Question Number : 123 Question Id : 4050366364 Question Type : MCQ Option Shuffling : Yes Display Question Number : Yes Is Question Mandatory : No Single Line Question Option : No Option Orientation : Vertical

Correct Marks : 4 Wrong Marks : 1

Directions : In each of the following 4 words, one word has been spelt wrongly. Choose the wrongly spelt word.

Options :

40503623139. Ballistic

40503623140. Bullock

40503623141. Bulletin

40503623142. Baloon

8/29/2020

Question Number : 124 Question Id : 4050366365 Question Type : MCQ Option Shuffling : Yes Display Question Number : Yes Is Question Mandatory : No Single Line Question Option : No Option Orientation : Vertical

Correct Marks : 4 Wrong Marks : 1

Directions : In each of the following 4 words, one word has been spelt wrongly. Choose the wrongly spelt word.

Options :

40503623143. Passanger

40503623144. Instructor

40503623145. Conquer

40503623146. Grammer

Question Number : 125 Question Id : 4050366366 Question Type : MCQ Option Shuffling : Yes Display Question Number : Yes Is Question Mandatory : No Single Line Question Option : No Option Orientation : Vertical

Correct Marks : 4 Wrong Marks : 1

Directions : In each of the following 4 words, one word has been spelt wrongly. Choose the wrongly spelt word.

Options :

40503623147. boredom

40503623148. implicit

40503623149. explicit

40503623150. bruchure

Sub-Section Number :

8

8/29/2020

Sub-Section Id : 405036492
Question Shuffling Allowed : Yes

Question Id : 4050366367 Question Type : COMPREHENSION Sub Question Shuffling Allowed : Yes Group Comprehension Questions : No

Question Numbers : (126 to 135)

Question Label : Comprehension

Directions : Fill in the blanks with the appropriate option given below.

Sub questions

Question Number : 126 Question Id : 4050366368 Question Type : MCQ Option Shuffling : Yes Display Question Number : Yes Is Question Mandatory : No Single Line Question Option : No Option Orientation : Vertical Correct Marks : 4 Wrong Marks : 1

During the lecture the teacher enlarged _____ the importance of the topic in our daily life.

Options :

40503623151. about

40503623152. for

40503623153. upon

40503623154. on

Question Number : 127 Question Id : 4050366369 Question Type : MCQ Option Shuffling : Yes Display Question Number : Yes Is Question Mandatory : No Single Line Question Option : No Option Orientation : Vertical Correct Marks : 4 Wrong Marks : 1

The visit of P.M. has been advanced _____ four days.

Options :

40503623155. For

8/29/2020

40503623156. By

40503623157. To

40503623158. With

Question Number : 128 Question Id : 4050366370 Question Type : MCQ Option Shuffling : Yes Display Question Number : Yes Is Question Mandatory : No Single Line Question Option : No Option Orientation : Vertical

Correct Marks : 4 Wrong Marks : 1

He is a man _____ humble origin.

Options :

40503623159. For

40503623160. With

40503623161. Of

40503623162. Over

Question Number : 129 Question Id : 4050366371 Question Type : MCQ Option Shuffling : Yes Display Question Number : Yes Is Question Mandatory : No Single Line Question Option : No Option Orientation : Vertical

Correct Marks : 4 Wrong Marks : 1

The cricket team with more number of all-rounders, has an advantage _____ the opponent team.

Options :

40503623163. at

40503623164. over

40503623165. above

40503623166. on

Question Number : 130 Question Id : 4050366372 Question Type : MCQ Option Shuffling : Yes Display Question Number : Yes Is Question Mandatory : No Single Line Question Option : No Option Orientation : Vertical

Correct Marks : 4 Wrong Marks : 1

The old school teacher was kind _____ the weak students.

Options :

40503623167. for

40503623168. at

40503623169. on

40503623170. to

Question Number : 131 Question Id : 4050366373 Question Type : MCQ Option Shuffling : Yes Display Question Number : Yes Is Question Mandatory : No Single Line Question Option : No Option Orientation : Vertical

Correct Marks : 4 Wrong Marks : 1

Some strange customs have _____ from earlier times.

Options :

40503623171. suspended

40503623172. survived

40503623173. desiccated

40503623174. disarranged

8/29/2020

Question Number : 132 Question Id : 4050366374 Question Type : MCQ Option Shuffling : Yes Display Question Number : Yes Is Question Mandatory : No Single Line Question Option : No Option Orientation : Vertical

Correct Marks : 4 Wrong Marks : 1

Ram is the _____ boy in the class.

Options :

40503623175. strongest and very tall

40503623176. strongest and tallest

40503623177. weakest and short

40503623178. weak and shortest

Question Number : 133 Question Id : 4050366375 Question Type : MCQ Option Shuffling : Yes Display Question Number : Yes Is Question Mandatory : No Single Line Question Option : No Option Orientation : Vertical

Correct Marks : 4 Wrong Marks : 1

Ants and Bees work together in large members, _____ they do so in a rigid manner and _____ with close relatives.

Options :

40503623179. If, but

40503623180. Only, but

40503623181. But, only

40503623182. And, only

Question Number : 134 Question Id : 4050366376 Question Type : MCQ Option Shuffling : Yes Display Question Number : Yes Is Question Mandatory : No Single Line Question Option : No Option Orientation : Vertical

8/29/2020

Correct Marks : 4 Wrong Marks : 1

To _____ yourself from _____ wear warm clothes.

Options :

40503623183. prohibit; heat

40503623184. protect; cold

40503623185. save; cold

40503623186. suffer; cold

Question Number : 135 Question Id : 4050366377 Question Type : MCQ Option Shuffling : Yes Display Question Number : Yes Is Question Mandatory : No Single Line Question Option : No Option Orientation : Vertical

Correct Marks : 4 Wrong Marks : 1

The crew of the boat _____ after its collision.

Options :

40503623187. drowned

40503623188. seized

40503623189. bound

40503623190. sink

Question Id : 4050366367 Question Type : COMPREHENSION Sub Question Shuffling Allowed : Yes Group Comprehension Questions : No

Question Numbers : (126 to 135)

Question Label : Comprehension

Directions : Fill in the blanks with the appropriate option given below.

8/29/2020

Sub questions

Question Number : 126 Question Id : 4050366368 Question Type : MCQ Option Shuffling : Yes Display Question Number : Yes Is Question Mandatory : No Single Line Question Option : No Option Orientation : Vertical Correct Marks : 4 Wrong Marks : 1

During the lecture the teacher enlarged _____ the importance of the topic in our daily life.

Options :

40503623151. about

40503623152. for

40503623153. upon

40503623154. on

Question Number : 127 Question Id : 4050366369 Question Type : MCQ Option Shuffling : Yes Display Question Number : Yes Is Question Mandatory : No Single Line Question Option : No Option Orientation : Vertical Correct Marks : 4 Wrong Marks : 1

The visit of P.M. has been advanced _____ four days.

Options :

40503623155. For

40503623156. By

40503623157. To

40503623158. With

Question Number : 128 Question Id : 4050366370 Question Type : MCQ Option Shuffling : Yes Display Question Number : Yes Is

8/29/2020

Question Mandatory : No Single Line Question Option : No Option Orientation : Vertical

Correct Marks : 4 Wrong Marks : 1

He is a man _____ humble origin.

Options :

40503623159. For

40503623160. With

40503623161. Of

40503623162. Over

Question Number : 129 Question Id : 4050366371 Question Type : MCQ Option Shuffling : Yes Display Question Number : Yes Is

Question Mandatory : No Single Line Question Option : No Option Orientation : Vertical

Correct Marks : 4 Wrong Marks : 1

The cricket team with more number of all-rounders, has an advantage _____ the opponent team.

Options :

40503623163. at

40503623164. over

40503623165. above

40503623166. on

Question Number : 130 Question Id : 4050366372 Question Type : MCQ Option Shuffling : Yes Display Question Number : Yes Is

Question Mandatory : No Single Line Question Option : No Option Orientation : Vertical

Correct Marks : 4 Wrong Marks : 1

The old school teacher was kind _____ the weak students.

8/29/2020

Options :

40503623167. for

40503623168. at

40503623169. on

40503623170. to

Question Number : 131 Question Id : 4050366373 Question Type : MCQ Option Shuffling : Yes Display Question Number : Yes Is Question Mandatory : No Single Line Question Option : No Option Orientation : Vertical

Correct Marks : 4 Wrong Marks : 1

Some strange customs have _____ from earlier times.

Options :

40503623171. suspended

40503623172. survived

40503623173. desiccated

40503623174. disarranged

Question Number : 132 Question Id : 4050366374 Question Type : MCQ Option Shuffling : Yes Display Question Number : Yes Is Question Mandatory : No Single Line Question Option : No Option Orientation : Vertical

Correct Marks : 4 Wrong Marks : 1

Ram is the _____ boy in the class.

Options :

40503623175. strongest and very tall

8/29/2020

40503623176. strongest and tallest

40503623177. weakest and short

40503623178. weak and shortest

Question Number : 133 Question Id : 4050366375 Question Type : MCQ Option Shuffling : Yes Display Question Number : Yes Is Question Mandatory : No Single Line Question Option : No Option Orientation : Vertical

Correct Marks : 4 Wrong Marks : 1

Ants and Bees work together in large members, _____ they do so in a rigid manner and _____ with close relatives.

Options :

40503623179. If, but

40503623180. Only, but

40503623181. But, only

40503623182. And, only

Question Number : 134 Question Id : 4050366376 Question Type : MCQ Option Shuffling : Yes Display Question Number : Yes Is Question Mandatory : No Single Line Question Option : No Option Orientation : Vertical

Correct Marks : 4 Wrong Marks : 1

To _____ yourself from _____ wear warm clothes.

Options :

40503623183. prohibit; heat

40503623184. protect; cold

8/29/2020

40503623185. save; cold

40503623186. suffer; cold

Question Number : 135 Question Id : 4050366377 Question Type : MCQ Option Shuffling : Yes Display Question Number : Yes Is Question Mandatory : No Single Line Question Option : No Option Orientation : Vertical Correct Marks : 4 Wrong Marks : 1

The crew of the boat _____ after its collision.

Options :

40503623187. drowned

40503623188. seized

40503623189. bound

40503623190. sink

Sub-Section Number :

9

Sub-Section Id :

405036493

Question Shuffling Allowed :

Yes

Question Id : 4050366378 Question Type : COMPREHENSION Sub Question Shuffling Allowed : Yes Group Comprehension Questions : No

Question Numbers : (136 to 140)

Question Label : Comprehension

Directions : Read the following passages carefully to answer the questions that follow.

Graduation is only a milestone in life journey. It does not mark the end of the education road. In a very real sense it is the commencement time, the beginning of a new journey which will test the toughness of your mental and moral fibre, the efficiency of your university training. The new experiences, the new problems and the new situations will demand from you the exercise of qualities for the fostering of which the university functions. In a new & Independent India the future will give powers & responsibilities to you. The historic role of the large educated classes in the building up of free India cannot be over estimated. If a leader is one who knows where he is going, who has a firm grasp of the insights & institutions which have made our civilization so enduring & who can harness them for every aspect of life, it is on the university that can train men for leadership.

The universities are more than institutions for higher learning & professional training. They are called upon to educate, younger generation, form character & create new type of intellectual leadership.

Sub questions

Question Number : 136 Question Id : 4050366379 Question Type : MCQ Option Shuffling : Yes Display Question Number : Yes Is Question Mandatory : No Single Line Question Option : No Option Orientation : Vertical

Correct Marks : 4 Wrong Marks : 1

The suitable title for the above passage is :

Options :

40503623191. Becoming a graduate

40503623192. High school

40503623193. University education

40503623194. Intellectual leadership

8/29/2020

Question Number : 137 Question Id : 4050366380 Question Type : MCQ Option Shuffling : Yes Display Question Number : Yes Is Question Mandatory : No Single Line Question Option : No Option Orientation : Vertical

Correct Marks : 4 Wrong Marks : 1

Graduation is :

Options :

40503623195. Just a degree

40503623196. The end of education

40503623197. Beginning of a new journey

40503623198. New problem route

Question Number : 138 Question Id : 4050366381 Question Type : MCQ Option Shuffling : Yes Display Question Number : Yes Is Question Mandatory : No Single Line Question Option : No Option Orientation : Vertical

Correct Marks : 4 Wrong Marks : 1

Toughness of your mental & moral fibre means.

Options :

40503623199. Strength of your mental & moral qualities

40503623200. Greatness

40503623201. Power of being educated

40503623202. Character

Question Number : 139 Question Id : 4050366382 Question Type : MCQ Option Shuffling : Yes Display Question Number : Yes Is Question Mandatory : No Single Line Question Option : No Option Orientation : Vertical

Correct Marks : 4 Wrong Marks : 1

8/29/2020

Which of the following words is closest in meaning to the word FOSTER .

Options :

40503623203. Encourage

40503623204. Dis Regard

40503623205. Discourage

40503623206. Disrespect

Question Number : 140 Question Id : 4050366383 Question Type : MCQ Option Shuffling : Yes Display Question Number : Yes Is Question Mandatory : No Single Line Question Option : No Option Orientation : Vertical

Correct Marks : 4 Wrong Marks : 1

Which of the following words is closest in meaning of commencement as used in the passage.

Options :

40503623207. Begin

40503623208. Close

40503623209. Stop

40503623210. Continue

Question Id : 4050366378 Question Type : COMPREHENSION Sub Question Shuffling Allowed : Yes Group Comprehension Questions : No

Question Numbers : (136 to 140)

Question Label : Comprehension

Directions : Read the following passages carefully to answer the questions that follow.

Graduation is only a milestone in life journey. It does not mark the end of the education road. In a very real sense it is the commencement time, the beginning of a new journey which will test the toughness of your mental and moral fibre, the efficiency of your university training. The new experiences, the new problems and the new situations will demand from you the exercise of qualities for the fostering of which the university functions. In a new & Independent India the future will give powers & responsibilities to you. The historic role of the large educated classes in the building up of free India cannot be over estimated. If a leader is one who knows where he is going, who has a firm grasp of the insights & institutions which have made our civilization so enduring & who can harness them for every aspect of life, it is on the university that can train men for leadership.

The universities are more than institutions for higher learning & professional training. They are called upon to educate, younger generation, form character & create new type of intellectual leadership.

Sub questions

Question Number : 136 Question Id : 4050366379 Question Type : MCQ Option Shuffling : Yes Display Question Number : Yes Is Question Mandatory : No Single Line Question Option : No Option Orientation : Vertical

Correct Marks : 4 Wrong Marks : 1

The suitable title for the above passage is :

Options :

40503623191. Becoming a graduate

40503623192. High school

40503623193. University education

40503623194. Intellectual leadership

8/29/2020

Question Number : 137 Question Id : 4050366380 Question Type : MCQ Option Shuffling : Yes Display Question Number : Yes Is Question Mandatory : No Single Line Question Option : No Option Orientation : Vertical Correct Marks : 4 Wrong Marks : 1

Graduation is :

Options :

40503623195. Just a degree

40503623196. The end of education

40503623197. Beginning of a new journey

40503623198. New problem route

Question Number : 138 Question Id : 4050366381 Question Type : MCQ Option Shuffling : Yes Display Question Number : Yes Is Question Mandatory : No Single Line Question Option : No Option Orientation : Vertical Correct Marks : 4 Wrong Marks : 1

Toughness of your mental & moral fibre means.

Options :

40503623199. Strength of your mental & moral qualities

40503623200. Greatness

40503623201. Power of being educated

40503623202. Character

Question Number : 139 Question Id : 4050366382 Question Type : MCQ Option Shuffling : Yes Display Question Number : Yes Is Question Mandatory : No Single Line Question Option : No Option Orientation : Vertical Correct Marks : 4 Wrong Marks : 1

8/29/2020

Which of the following words is closest in meaning to the word FOSTER .

Options :

40503623203. Encourage

40503623204. Dis Regard

40503623205. Discourage

40503623206. Disrespect

Question Number : 140 Question Id : 4050366383 Question Type : MCQ Option Shuffling : Yes Display Question Number : Yes Is Question Mandatory : No Single Line Question Option : No Option Orientation : Vertical

Correct Marks : 4 Wrong Marks : 1

Which of the following words is closest in meaning of commencement as used in the passage.

Options :

40503623207. Begin

40503623208. Close

40503623209. Stop

40503623210. Continue

Sub-Section Number :

10

Sub-Section Id :

405036494

Question Shuffling Allowed :

Yes

Question Id : 4050366384 Question Type : COMPREHENSION Sub Question Shuffling Allowed : Yes Group Comprehension Questions : No

Question Numbers : (141 to 145)

Question Label : Comprehension

Direction : Read the following passage carefully to answer the question that follow.

Street theatre in India is a well established ancient art form, despite the proliferation of modern means of entertainment and communication, street theatre continues to flourish in India. Street theatre as a channel of communication has for centuries been propogating reforms, by highlighting social, economic and political issues present in the society.

Unlike in the olden days, its performance is no longer restricted to villages or small localities of the city. Today, small groups of performers, including students, would stage performances to mobilise public opinion or to help create or raise awareness over an issue of particular public importance.

Sub questions

Question Number : 141 Question Id : 4050366385 Question Type : MCQ Option Shuffling : Yes Display Question Number : Yes Is Question Mandatory : No Single Line Question Option : No Option Orientation : Vertical

Correct Marks : 4 Wrong Marks : 1

According to the passage, what is a well established art form, that is also ancient.

Options :

40503623211. Cinema

40503623212. Music

40503623213. Street theatre

40503623214. Classical Dance

Question Number : 142 Question Id : 4050366386 Question Type : MCQ Option Shuffling : Yes Display Question Number : Yes Is Question Mandatory : No Single Line Question Option : No Option Orientation : Vertical

Correct Marks : 4 Wrong Marks : 1

Which is the important issue, that street theatre does NOT deal with (as in passage)

Options :

8/29/2020

40503623215. Social

40503623216. Religious

40503623217. Economic

40503623218. Political

Question Number : 143 Question Id : 4050366387 Question Type : MCQ Option Shuffling : Yes Display Question Number : Yes Is Question Mandatory : No Single Line Question Option : No Option Orientation : Vertical Correct Marks : 4 Wrong Marks : 1

In olden days, where were street theatre performances mostly done.

Options :

40503623219. In colleges

40503623220. In city centre

40503623221. In villages

40503623222. In schools

Question Number : 144 Question Id : 4050366388 Question Type : MCQ Option Shuffling : Yes Display Question Number : Yes Is Question Mandatory : No Single Line Question Option : No Option Orientation : Vertical Correct Marks : 4 Wrong Marks : 1

Which is the group that has joined the street theatre art form in modern times.

Options :

40503623223. Office workers

40503623224. Housewives

8/29/2020

40503623225. Students

40503623226. Govt. Servants

Question Number : 145 Question Id : 4050366389 Question Type : MCQ Option Shuffling : Yes Display Question Number : Yes Is Question Mandatory : No Single Line Question Option : No Option Orientation : Vertical Correct Marks : 4 Wrong Marks : 1

When street theatre mobilise public opinion over an important issue, they

Options :

40503623227. Raise awareness

40503623228. Raise income

40503623229. Raise anger

40503623230. Raise hatred

Question Id : 4050366384 Question Type : COMPREHENSION Sub Question Shuffling Allowed : Yes Group Comprehension Questions : No

Question Numbers : (141 to 145)

Question Label : Comprehension

Direction : Read the following passage carefully to answer the question that follow.

Street theatre in India is a well established ancient art form, despite the proliferation of modern means of entertainment and communication, street theatre continues to flourish in India. Street theatre as a channel of communication has for centuries been propogating reforms, by highlighting social, economic and political issues present in the society.

Unlike in the olden days, its performance is no longer restricted to villages or small localities of the city. Today, small groups of performers, including students, would stage performances to mobilise public opinion or to help create or raise awareness over an issue of particular public importance.

Sub questions

Question Number : 141 Question Id : 4050366385 Question Type : MCQ Option Shuffling : Yes Display Question Number : Yes Is Question Mandatory : No Single Line Question Option : No Option Orientation : Vertical Correct Marks : 4 Wrong Marks : 1

According to the passage, what is a well established art form, that is also ancient.

Options :

- 40503623211. Cinema
- 40503623212. Music
- 40503623213. Street theatre
- 40503623214. Classical Dance

Question Number : 142 Question Id : 4050366386 Question Type : MCQ Option Shuffling : Yes Display Question Number : Yes Is Question Mandatory : No Single Line Question Option : No Option Orientation : Vertical Correct Marks : 4 Wrong Marks : 1

Which is the important issue, that street theatre does NOT deal with (as in passage)

Options :

- 40503623215. Social

40503623216. Religious

40503623217. Economic

40503623218. Political

Question Number : 143 Question Id : 4050366387 Question Type : MCQ Option Shuffling : Yes Display Question Number : Yes Is Question Mandatory : No Single Line Question Option : No Option Orientation : Vertical Correct Marks : 4 Wrong Marks : 1

In olden days, where were street theatre performances mostly done.

Options :

40503623219. In colleges

40503623220. In city centre

40503623221. In villages

40503623222. In schools

Question Number : 144 Question Id : 4050366388 Question Type : MCQ Option Shuffling : Yes Display Question Number : Yes Is Question Mandatory : No Single Line Question Option : No Option Orientation : Vertical Correct Marks : 4 Wrong Marks : 1

Which is the group that has joined the street theatre art form in modern times.

Options :

40503623223. Office workers

40503623224. Housewives

8/29/2020

40503623225. Students

40503623226. Govt. Servants

Question Number : 145 Question Id : 4050366389 Question Type : MCQ Option Shuffling : Yes Display Question Number : Yes Is Question Mandatory : No Single Line Question Option : No Option Orientation : Vertical

Correct Marks : 4 Wrong Marks : 1

When street theatre mobilise public opinion over an important issue, they

Options :

40503623227. Raise awareness

40503623228. Raise income

40503623229. Raise anger

40503623230. Raise hatred

Sub-Section Number :

11

Sub-Section Id :

405036495

Question Shuffling Allowed :

Yes

Question Id : 4050366390 Question Type : COMPREHENSION Sub Question Shuffling Allowed : Yes Group Comprehension Questions : No

Question Numbers : (146 to 150)

Question Label : Comprehension

Direction : Read the following passage carefully to answer the questions :

The team India Cricket Shop opened with the Smashing of a cocount on the morning of 29 April 2000. All our immediate families had come. My mother and Omi's family were visibly happy while Ish's parents were silent. They still visualised Ish as an army officer, not a shopkeeper in Belrampur.

'May Laxmi shower all blessings on you Hardworking boys', - Omi's mother said before she left.

Soon, it was just us in our twenty-feet-by-ten-feet shop.

'Move the counter in, the shutter won't close', Ish screamed at Omi. Omi's forehead broke into sweat as he lifted the bulky countertop yet again to move it back an inch.

I stepped out of the shop and crossed the road for the tenth time to look at the board. It was six feet wide and two feet tall. We had painted it blue - The colour of the Indian Cricket team. In the centre, we had the letters 'Team India Cricket Shop' in the colours of the Indian flag. The excited painter from Shahpur had thrown in the faces of Tendulkar & Ganguly for free. Ganguly had a squint and Tendulkar's lips looked bee-stung, but it all added to the charm.

Sub questions

Question Number : 146 Question Id : 4050366391 Question Type : MCQ Option Shuffling : Yes Display Question Number : Yes Is Question Mandatory : No Single Line Question Option : No Option Orientation : Vertical

Correct Marks : 4 Wrong Marks : 1

Where "The Team India Cricket Shop" is located ?

Options :

40503623231. New Delhi

40503623232. Shahpur

40503623233. Belrampur

8/29/2020

40503623234. MCG Ground

Question Number : 147 Question Id : 4050366392 Question Type : MCQ Option Shuffling : Yes Display Question Number : Yes Is Question Mandatory : No Single Line Question Option : No Option Orientation : Vertical Correct Marks : 4 Wrong Marks : 1

Apart from the author names of other two partners of the shop are :

Options :

40503623235. Ish and Omi

40503623236. Tendulkar and Ganguly

40503623237. Ish and Chetan

40503623238. Omi and Bhagat

Question Number : 148 Question Id : 4050366393 Question Type : MCQ Option Shuffling : Yes Display Question Number : Yes Is Question Mandatory : No Single Line Question Option : No Option Orientation : Vertical Correct Marks : 4 Wrong Marks : 1

The word "Squint" means :

Options :

40503623239. wrinkled forehead

40503623240. eye glasses

40503623241. eyes that look in different direction

40503623242. Grumpy face

Question Number : 149 Question Id : 4050366394 Question Type : MCQ Option Shuffling : Yes Display Question Number : Yes Is Question Mandatory : No Single Line Question Option : No Option Orientation : Vertical

Correct Marks : 4 Wrong Marks : 1

Why Ish's parents were silent ?

Options :

- 40503623243. They did not like the name of the shop
- 40503623244. They were feeling uncomfortable due to heat
- 40503623245. They wanted Ish to become an army officer
- 40503623246. The counter was creating problem in the shop

Question Number : 150 Question Id : 4050366395 Question Type : MCQ Option Shuffling : Yes Display Question Number : Yes Is Question Mandatory : No Single Line Question Option : No Option Orientation : Vertical

Correct Marks : 4 Wrong Marks : 1

What were the colors of the letters on the board of the shop ?

Options :

- 40503623247. Blue-Indian cricket team
- 40503623248. Dark black
- 40503623249. Saffron, white & green
- 40503623250. Blue & Black

Question Id : 4050366390 Question Type : COMPREHENSION Sub Question Shuffling Allowed : Yes Group Comprehension Questions

8/29/2020

: No

Question Numbers : (146 to 150)

Question Label : Comprehension

Direction : Read the following passage carefully to answer the questions :

The team India Cricket Shop opened with the Smashing of a cocount on the morning of 29 April 2000. All our immediate families had come. My mother and Omi's family were visibly happy while Ish's parents were silent. They still visualised Ish as an army officer, not a shopkeeper in Belrampur.

'May Laxmi shower all blessings on you Hardworking boys', - Omi's mother said before she left.

Soon, it was just us in our twenty-feet-by-ten-feet shop.

'Move the counter in, the shutter won't close', Ish screamed at Omi. Omi's forehead broke into sweat as he lifted the bulky countertop yet again to move it back an inch.

I stepped out of the shop and crossed the road for the tenth time to look at the board. It was six feet wide and two feet tall. We had painted it blue - The colour of the Indian Cricket team. In the centre, we had the letters 'Team India Cricket Shop' in the colours of the Indian flag. The excited painter from Shahpur had thrown in the faces of Tendulkar & Ganguly for free. Ganguly had a squint and Tendulkar's lips looked bee-stung, but it all added to the charm.

Sub questions

Question Number : 146 Question Id : 4050366391 Question Type : MCQ Option Shuffling : Yes Display Question Number : Yes Is Question Mandatory : No Single Line Question Option : No Option Orientation : Vertical

Correct Marks : 4 Wrong Marks : 1

Where "The Team India Cricket Shop" is located ?

Options :

40503623231. New Delhi

40503623232. Shahpur

8/29/2020

40503623233. Belrampur

40503623234. MCG Ground

Question Number : 147 Question Id : 4050366392 Question Type : MCQ Option Shuffling : Yes Display Question Number : Yes Is Question Mandatory : No Single Line Question Option : No Option Orientation : Vertical Correct Marks : 4 Wrong Marks : 1

Apart from the author names of other two partners of the shop are :

Options :

40503623235. Ish and Omi

40503623236. Tendulkar and Ganguly

40503623237. Ish and Chetan

40503623238. Omi and Bhagat

Question Number : 148 Question Id : 4050366393 Question Type : MCQ Option Shuffling : Yes Display Question Number : Yes Is Question Mandatory : No Single Line Question Option : No Option Orientation : Vertical Correct Marks : 4 Wrong Marks : 1

The word "Squint" means :

Options :

40503623239. wrinkled forehead

40503623240. eye glasses

40503623241. eyes that look in different direction

8/29/2020

40503623242. Grumpy face

Question Number : 149 Question Id : 4050366394 Question Type : MCQ Option Shuffling : Yes Display Question Number : Yes Is Question Mandatory : No Single Line Question Option : No Option Orientation : Vertical Correct Marks : 4 Wrong Marks : 1

Why Ish's parents were silent ?

Options :

40503623243. They did not like the name of the shop

40503623244. They were feeling uncomfortable due to heat

40503623245. They wanted Ish to become an army officer

40503623246. The counter was creating problem in the shop

Question Number : 150 Question Id : 4050366395 Question Type : MCQ Option Shuffling : Yes Display Question Number : Yes Is Question Mandatory : No Single Line Question Option : No Option Orientation : Vertical Correct Marks : 4 Wrong Marks : 1

What were the colors of the letters on the board of the shop ?

Options :

40503623247. Blue-Indian cricket team

40503623248. Dark black

40503623249. Saffron, white & green

40503623250. Blue & Black

Aptitude for service sector

Section Id :	405036225
Section Number :	5
Section type :	Online
Mandatory or Optional :	Mandatory
Number of Questions :	50
Number of Questions to be attempted :	50
Section Marks :	200
Display Number Panel :	Yes
Group All Questions :	Yes
Mark As Answered Required? :	Yes
Sub-Section Number :	1
Sub-Section Id :	405036496
Question Shuffling Allowed :	Yes

Question Number : 151 Question Id : 4050366396 Question Type : MCQ Option Shuffling : Yes Display Question Number : Yes Is Question Mandatory : No Single Line Question Option : No Option Orientation : Vertical Correct Marks : 4 Wrong Marks : 1

You are in an elevator with two other strangers and the electricity goes off in between. What would you do ?

Options :

40503623251. Panic and scream in the elevator.

40503623252. Let the other people decide the course of action while you stand there and watch.

40503623253. Try to break open the elevator.

40503623254. Keep calm and try and ring the emergency alarm to seek help.

Question Number : 151 Question Id : 4050366396 Question Type : MCQ Option Shuffling : Yes Display Question Number : Yes Is Question Mandatory : No Single Line Question Option : No Option Orientation : Vertical

Correct Marks : 4 Wrong Marks : 1

आप दो अन्य अजनबियों के साथ एलिवेटर में है इसी बीच बिजली चली जाती है आप क्या करेंगे ?

Options :

40503623251. एलिवेटर में भयभीत होकर चिल्लाने लगेंगे।

40503623252. अन्य व्यक्ति अगला उचित कदम उठाएँ जबकि आप खड़े रहें और उन्हें देखते रहें।

40503623253. एलिवेटर को जबरदस्ती खोलने का प्रयास करें।

40503623254. शांत रहे और आपातकालीन अलार्म को बजाकर सहायता माँगने की कोशिश करें।

Question Number : 152 Question Id : 4050366397 Question Type : MCQ Option Shuffling : Yes Display Question Number : Yes Is Question Mandatory : No Single Line Question Option : No Option Orientation : Vertical

Correct Marks : 4 Wrong Marks : 1

Annual day function is to be organised in your school, the responsibility of this has been assigned to you. You would :

Options :

40503623255. Try to get rid of this responsibility.

8/29/2020

40503623256. Try to organize it with the help of your batchmates.

40503623257. Avoid all your responsibilities.

40503623258. Delegate it to someone else.

Question Number : 152 Question Id : 4050366397 Question Type : MCQ Option Shuffling : Yes Display Question Number : Yes Is Question Mandatory : No Single Line Question Option : No Option Orientation : Vertical Correct Marks : 4 Wrong Marks : 1

आपके विद्यालय में वार्षिकोत्सव मनाया जाना है और उसके आयोजन की जिम्मेदारी आपको दी गई है आप क्या करेंगे ?

Options :

40503623255. इस जिम्मेदारी से हटने की कोशिश करें।

40503623256. अपने बैचमेटों के सहयोग से इसके आयोजन की कोशिश करें।

40503623257. अपनी सभी जिम्मेदारियों को अनदेखा करें।

40503623258. इस कार्य को किसी और को सौंप दें।

Question Number : 153 Question Id : 4050366398 Question Type : MCQ Option Shuffling : Yes Display Question Number : Yes Is Question Mandatory : No Single Line Question Option : No Option Orientation : Vertical Correct Marks : 4 Wrong Marks : 1

What do you do when you reach late for your class ?

8/29/2020

Options :

40503623259. Quietly try to sneak into the class without being noticed by the teacher.
40503623260. Do not attend the class only.
40503623261. Admit your reason for being late in the class and whole heartedly accept the teacher's decision.
40503623262. Make up excuses to convince the teacher.

Question Number : 153 Question Id : 4050366398 Question Type : MCQ Option Shuffling : Yes Display Question Number : Yes Is Question Mandatory : No Single Line Question Option : No Option Orientation : Vertical Correct Marks : 4 Wrong Marks : 1

जब आप अपनी कक्षा में देर से पहुँचते हैं, तब आप क्या करते हैं?

Options :

40503623259. शिक्षक की बिना जानकारी के चुपके से कक्षा में घुसते हैं।
40503623260. केवल कक्षा में ही नहीं जाते।
40503623261. कक्षा में देर से आने का कारण बताकर हृदय से शिक्षक का परिणाम स्वीकार करते हैं।
40503623262. शिक्षक को बहाने बनाकर कायल करते हैं।

Question Number : 154 Question Id : 4050366399 Question Type : MCQ Option Shuffling : Yes Display Question Number : Yes Is Question Mandatory : No Single Line Question Option : No Option Orientation : Vertical Correct Marks : 4 Wrong Marks : 1

In an examination hall, you find that your question paper is too tough. The best thing you can do is :

Options :

40503623263. Try cheating from your neighbouring student.

40503623264. Leave the paper and walk out.

40503623265. Try attempting those questions first, of which you know the answers.

40503623266. Write irrelevant matter to just fill in the pages.

Question Number : 154 Question Id : 4050366399 Question Type : MCQ Option Shuffling : Yes Display Question Number : Yes Is Question Mandatory : No Single Line Question Option : No Option Orientation : Vertical Correct Marks : 4 Wrong Marks : 1

एक परीक्षा भवन में आपको ज्ञात होता है कि आपका प्रश्न-पत्र बहुत ही कठिन है ऐसी स्थिति में आपके लिए क्या अच्छा रहेगा ?

Options :

40503623263. अपने बगल वाले छात्र से नकल करने की कोशिश करना।

8/29/2020

40503623264. प्रश्न-पत्र छोड़कर परीक्षा-भवन से निकल जाना।

40503623265. सबसे पहले उन प्रश्नों को हल करने की कोशिश करना जिनके उत्तर आप जानते हैं।

40503623266. पृष्ठों को केवल भरने के लिए असंगत बातें लिखना।

Question Number : 155 Question Id : 4050366400 Question Type : MCQ Option Shuffling : Yes Display Question Number : Yes Is Question Mandatory : No Single Line Question Option : No Option Orientation : Vertical Correct Marks : 4 Wrong Marks : 1

While working in a group, you tend to :

Options :

40503623267. Adjust with other members, but as per your convenience.

40503623268. Be a bit hesitant.

40503623269. Not involved with the group activity.

40503623270. Extend full cooperation to the other group members.

Question Number : 155 Question Id : 4050366400 Question Type : MCQ Option Shuffling : Yes Display Question Number : Yes Is Question Mandatory : No Single Line Question Option : No Option Orientation : Vertical Correct Marks : 4 Wrong Marks : 1

एक समूह में कार्य करते समय, आप यह कोशिश कर सकते हैं :

Options :

40503623267. अन्य सदस्यों के साथ सामंजस्य बैठाना लेकिन अपनी सुविधा के अनुसार।
40503623268. कुछ हिचक बनाए रखना।
40503623269. समूह-कार्यकलापों में शामिल नहीं होना।
40503623270. समूह के अन्य सदस्यों को पूरा सहयोग देना।

Question Number : 156 Question Id : 4050366401 Question Type : MCQ Option Shuffling : Yes Display Question Number : Yes Is Question Mandatory : No Single Line Question Option : No Option Orientation : Vertical

Correct Marks : 4 Wrong Marks : 1

You are transferred to a section in your school where you do not have any friends, you would :

Options :

40503623271. Sit in one corner of the class and not take interest in anything.
40503623272. Cry, for you do not like your surroundings.
40503623273. Try and make new friends in the new section.
40503623274. Ignore everything and just concentrate on your studies.

Question Number : 156 Question Id : 4050366401 Question Type : MCQ Option Shuffling : Yes Display Question Number : Yes Is Question Mandatory : No Single Line Question Option : No Option Orientation : Vertical

Correct Marks : 4 Wrong Marks : 1

आपका अपने विद्यालय के उस सेक्शन में स्थानान्तरण हो गया है जहाँ आपके कोई दोस्त नहीं है तो आप :

Options :

40503623271. कक्षा के एक किनारे में बैठ जाना और किसी में भी दिलचस्पी नहीं लेना।

40503623272. चिल्ला कर कहें कि आपका यहाँ कुछ भी अच्छा नहीं लगता।

40503623273. नए सेक्शन में नए दोस्त बनाना और उसकी कोशिश करना।

40503623274. सब चीजों को अनदेखा कर अपनी पढ़ाई पर ध्यान देना।

Question Number : 157 Question Id : 4050366402 Question Type : MCQ Option Shuffling : Yes Display Question Number : Yes Is Question Mandatory : No Single Line Question Option : No Option Orientation : Vertical

Correct Marks : 4 Wrong Marks : 1

You find a lady entering your restaurant carrying a lot of bags in hand, you will :

Options :

40503623275. Rush to open the door and help her with her bags.

40503623276. Not bother about the same.

40503623277. Be agitated due to shortage of space in the restaurant.

40503623278. Ask her to leave her bags outside.

Question Number : 157 Question Id : 4050366402 Question Type : MCQ Option Shuffling : Yes Display Question Number : Yes Is Question Mandatory : No Single Line Question Option : No Option Orientation : Vertical

Correct Marks : 4 Wrong Marks : 1

आप देखते हैं कि एक महिला हाथ में अनेक बैग लेकर आपके रेस्टॉरेंट में प्रवेश कर रही है आप :

Options :

40503623275. दरवाजा खोलने के लिए तत्पर होंगे और उसे बैग उठाने में मदद करेंगे।

40503623276. उसकी कोई चिन्ता नहीं करेंगे।

40503623277. रेस्टॉरेंट में जगह की कमी के कारण परेशान हो जाएँगे।

40503623278. उसे अपने बैग बाहर रखने के लिए कहेंगे।

Question Number : 158 Question Id : 4050366403 Question Type : MCQ Option Shuffling : Yes Display Question Number : Yes Is Question Mandatory : No Single Line Question Option : No Option Orientation : Vertical

Correct Marks : 4 Wrong Marks : 1

As a manager you notice there has been repeated customer complaints against a subordinate, you will :

8/29/2020

Options :

40503623279. Reprimand him and give him a deadline to improve.
40503623280. Fire him from the job.
40503623281. Ask other colleagues to warn him about the same.
40503623282. Try to find out the problem and give him a remedial training.

Question Number : 158 Question Id : 4050366403 Question Type : MCQ Option Shuffling : Yes Display Question Number : Yes Is Question Mandatory : No Single Line Question Option : No Option Orientation : Vertical

Correct Marks : 4 Wrong Marks : 1

एक प्रबंधक के तौर पर क्या करेंगे जब ग्राहक आपके एक अधीनस्थ के विरुद्ध बार-बार शिकायत करते हों :

Options :

40503623279. उसे फटकार लगाएंगे और सुधरने की एक समय-सीमा देंगे।
40503623280. उसे नौकरी से निकाल देंगे।
40503623281. अन्य सहकर्मियों को इस बारे में उसे चेतावनी देने को कहेंगे।
40503623282. समस्या को जानने की कोशिश करें और उसमें सुधार आने का प्रशिक्षण दें।

Question Number : 159 Question Id : 4050366404 Question Type : MCQ Option Shuffling : Yes Display Question Number : Yes Is Question Mandatory : No Single Line Question Option : No Option Orientation : Vertical

Correct Marks : 4 Wrong Marks : 1

Only a hard working person can move ahead in life. What is your opinion ?

Options :

40503623283. Hard working people are not always successful.

40503623284. Hard working people are never successful.

40503623285. A hardworking person will definitely succeed, sooner or later.

40503623286. It all depends on your luck.

Question Number : 159 Question Id : 4050366404 Question Type : MCQ Option Shuffling : Yes Display Question Number : Yes Is Question Mandatory : No Single Line Question Option : No Option Orientation : Vertical

Correct Marks : 4 Wrong Marks : 1

जीवन में केवल कठिन परिश्रमी व्यक्ति ही आगे बढ़ता है। आपकी राय क्या है?

Options :

40503623283. कठिन परिश्रमी व्यक्ति हमेशा सफल नहीं होते हैं।

40503623284. कठिन परिश्रमी व्यक्ति कभी सफल नहीं होते हैं।

40503623285. एक कठिन परिश्रमी व्यक्ति जल्दी अथवा बाद में अवश्य सफल होता है।

40503623286. यह सब आपके भाग्य पर निर्भर रहता है।

Question Number : 160 Question Id : 4050366405 Question Type : MCQ Option Shuffling : Yes Display Question Number : Yes Is Question Mandatory : No Single Line Question Option : No Option Orientation : Vertical Correct Marks : 4 Wrong Marks : 1

One of your roommate has the habit of speaking loudly over the phone which disturbs you while studying. Despite your repeated requests, his habit seems to be getting worse. You :

Options :

40503623287. Start speaking loudly when your roommate is studying to teach him a lesson.

40503623288. Fight with your roommate.

40503623289. Complain about your roommate to the hostel warden.

40503623290. Have an open discussion with your roommate about your problem and try to solve it amicably.

Question Number : 160 Question Id : 4050366405 Question Type : MCQ Option Shuffling : Yes Display Question Number : Yes Is Question Mandatory : No Single Line Question Option : No Option Orientation : Vertical Correct Marks : 4 Wrong Marks : 1

आपके एक रूम-मेट में टेलिफोन में जोर-जोर से बोलने की आदत है जो आपको पढ़ाई में बाधा पहुँचाता है आपके बार-बार अनुरोधों के बावजूद, उसकी यह आदत और बिगड रही है आप :

Options :

40503623287. जब आपका रूम-मेट पढ़ाई कर रहा हो, उसे एक सीख देने के लिए जोर-जोर से बोलना प्रारम्भ कर दें।

40503623288. अपने रूम-मेट से इस संबंध में लड़ाई करें।

40503623289. होस्टल वार्डन को अपने रूम-मेट की शिकायत करें।

40503623290. अपने रूम-मेट से समस्या के बारे में खुली चर्चा करें और सौहार्द से समस्या का निदान करने की कोशिश करें।

Question Number : 161 Question Id : 4050366406 Question Type : MCQ Option Shuffling : Yes Display Question Number : Yes Is Question Mandatory : No Single Line Question Option : No Option Orientation : Vertical

Correct Marks : 4 Wrong Marks : 1

In the class you are delivering a speech when a classmate of yours is continuously interrupting you with several queries, you would :

Options :

40503623291. Not pay attention to him.

40503623292. Start speaking at a faster pace than before.

40503623293. Stop the speech and let him speak.

40503623294. Politely let him know that all his queries will be addressed at the end.

Question Number : 161 Question Id : 4050366406 Question Type : MCQ Option Shuffling : Yes Display Question Number : Yes Is Question Mandatory : No Single Line Question Option : No Option Orientation : Vertical

Correct Marks : 4 Wrong Marks : 1

आप अपनी कक्षा में एक व्याख्यान दे रहे हैं तब आपके सहपाठी आपको अनेक प्रश्न पूछ कर बीच में बार-बार बाधा पहुँचा रहे हैं आप क्या करेंगे ?

Options :

40503623291. उनकी ओर ध्यान नहीं दे।

40503623292. पहले से अधिक जोर से बोलना शुरू कर दें।

40503623293. व्याख्यान को बंद कर उन्हें बोलने का मौका दें।

40503623294. उन्हें बड़ी विनम्रता से कहें कि व्याख्यान के अंत में सभी प्रश्नों का उत्तर दिया जाएगा।

Question Number : 162 Question Id : 4050366407 Question Type : MCQ Option Shuffling : Yes Display Question Number : Yes Is Question Mandatory : No Single Line Question Option : No Option Orientation : Vertical

Correct Marks : 4 Wrong Marks : 1

8/29/2020

There has been a sudden death in the family recently and you are still grieving. However you have your annual examination round the corner and for that you have to catch up with a lot of studies. What would you do ?

Options :

40503623295. You will get back to studying after you get over your grief.
40503623296. You will ignore your examination and continue grieving.
40503623297. You will motivate yourself to get back to studying as only grieving will not do any good to you.
40503623298. You will run away from everything.

Question Number : 162 Question Id : 4050366407 Question Type : MCQ Option Shuffling : Yes Display Question Number : Yes Is Question Mandatory : No Single Line Question Option : No Option Orientation : Vertical Correct Marks : 4 Wrong Marks : 1

हाल ही में, परिवार में अचानक मृत्यु होने पर आप अभी तक शोक मना रहे हैं तथापि, शीघ्र ही आपकी वार्षिक परीक्षाएँ होनी हैं और उसके लिए आपको बहुत कुछ पढ़ना शेष है, आप क्या करेंगे ?

Options :

40503623295. आप शोक से उबरने के बाद अपनी पढ़ाई पर ध्यान देंगे।

8/29/2020

40503623296. आप अपनी परीक्षा का ध्यान न रखकर, शोकाकुल बने रहेंगे।

40503623297. आप हिम्मत करके पढ़ाई में जुट जाएँगे क्योंकि शोक करने से आपको कुछ हासिल नहीं होना है।

40503623298. आप सभी चीजों को छोड़ देंगे।

Question Number : 163 Question Id : 4050366408 Question Type : MCQ Option Shuffling : Yes Display Question Number : Yes Is Question Mandatory : No Single Line Question Option : No Option Orientation : Vertical Correct Marks : 4 Wrong Marks : 1

If an argument starts with someone, then I invariably :

Options :

40503623299. Listen to the viewpoint of that person carefully and then speak what is in my mind.

40503623300. State my view at the very outset.

40503623301. Start saying whatever comes to my mind.

40503623302. Be confused and perplexed.

Question Number : 163 Question Id : 4050366408 Question Type : MCQ Option Shuffling : Yes Display Question Number : Yes Is Question Mandatory : No Single Line Question Option : No Option Orientation : Vertical

8/29/2020

Correct Marks : 4 Wrong Marks : 1

यदि किसी से कोई वाद-विवाद शुरू हो जाता है तो मैं हमेशा :

Options :

40503623299. उस व्यक्ति के दृष्टिकोण को ध्यानपूर्वक सुनकर, तब अपनी बात करता हूँ।

40503623300. प्रारम्भ में ही अपना दृष्टिकोण कह देता हूँ।

40503623301. जो भी मेरे मस्तिष्क में आता है, उसे बोलने लगता हूँ।

40503623302. भ्रम एवं संशय में रहता हूँ।

Question Number : 164 Question Id : 4050366409 Question Type : MCQ Option Shuffling : Yes Display Question Number : Yes Is Question Mandatory : No Single Line Question Option : No Option Orientation : Vertical

Correct Marks : 4 Wrong Marks : 1

Your neighbour is continuously throwing garbage in your premise despite repeated warnings. You would :

Options :

40503623303. Go to their house and engage into a fight with them.

40503623304. Inform the police about this incident.

40503623305. Take the garbage and throw it back in their premise.

Ask them the reason for their action and sternly yet politely ask them to stop this nuisance.
40503623306.

Question Number : 164 Question Id : 4050366409 Question Type : MCQ Option Shuffling : Yes Display Question Number : Yes Is Question Mandatory : No Single Line Question Option : No Option Orientation : Vertical Correct Marks : 4 Wrong Marks : 1

आपका पड़ोसी बार-बार चेतावनी देने के बावजूद भी आपके परिसर में कूड़ा फेंकता है, आप :

Options :

40503623303. उनके घर जाकर उनसे हाथापाई करना ।
40503623304. इसके बारे में पुलिस को सूचित करना ।
40503623305. उस कूड़े को लेकर फिर उनके परिसर में फेंकना ।
40503623306. उनके इस कृत्य का कारण पूछें और सख्ती व नम्रता से इसे बंद करने का अनुरोध करें ।

Question Number : 165 Question Id : 4050366410 Question Type : MCQ Option Shuffling : Yes Display Question Number : Yes Is Question Mandatory : No Single Line Question Option : No Option Orientation : Vertical Correct Marks : 4 Wrong Marks : 1

Your close relative has gifted you a birthday present, which you did not like much. You will :

Options :

40503623307. Openly express your dislike.

40503623308. Request him to exchange the item.

40503623309. Respect the feelings of the person and use the gift appropriately.

40503623310. Give a hint that the gift is not to your liking.

Question Number : 165 Question Id : 4050366410 Question Type : MCQ Option Shuffling : Yes Display Question Number : Yes Is Question Mandatory : No Single Line Question Option : No Option Orientation : Vertical Correct Marks : 4 Wrong Marks : 1

आपके निकट संबंधी ने आपको जन्मदिन का एक उपहार दिया है जिसे आप ज्यादा पसंद नहीं करते हैं, आप क्या करेंगे ?

Options :

40503623307. खुले तौर पर अपनी नापसंदी जाहिर करें।

40503623308. उसे उपहार को बदलने का अनुरोध करें।

40503623309. व्यक्ति की भावनाओं का सम्मान कर उपहार का यथोचित उपयोग करें।

40503623310. उन्हें यह संकेत दें कि यह उपहार उसके पसंद का नहीं है।

Question Number : 166 Question Id : 4050366411 Question Type : MCQ Option Shuffling : Yes Display Question Number : Yes Is

Question Mandatory : No Single Line Question Option : No Option Orientation : Vertical

Correct Marks : 4 Wrong Marks : 1

You observe that you are burdened with extra work in your workplace compared to your other colleagues. You would :

Options :

40503623311. Continue doing the work in spite of increasing stress levels.
40503623312. Revolt outright.
40503623313. Politely reason out the situation with your supervisor.
40503623314. Gain sympathy of others.

Question Number : 166 Question Id : 4050366411 Question Type : MCQ Option Shuffling : Yes Display Question Number : Yes Is

Question Mandatory : No Single Line Question Option : No Option Orientation : Vertical

Correct Marks : 4 Wrong Marks : 1

आप पाते हैं कि कार्यस्थल में आपके अन्य सहकर्मियों की अपेक्षा आपको अतिरिक्त काम दिया गया है आप क्या करेंगे ?

Options :

40503623311. आपका तनाव स्तर बढ़ने के बावजूद कार्य करना जारी रखेंगे।
40503623312. सीधे विद्रोह करेंगे।

40503623313. नम्रता से अपने वरिष्ठ को स्थिति की जानकारी देंगे।

40503623314. अन्य सहकर्मियों से सहानुभूति ग्रहण करें।

Question Number : 167 Question Id : 4050366412 Question Type : MCQ Option Shuffling : Yes Display Question Number : Yes Is Question Mandatory : No Single Line Question Option : No Option Orientation : Vertical Correct Marks : 4 Wrong Marks : 1

You are never in limelight or focus inspite of your efficiency at work. You would :

Options :

40503623315. Lower your performance level.

40503623316. Continue working and wait for the moment of recognition.

40503623317. Keep silent regarding your grievances.

40503623318. Openly publicise your efficiency and proclaim that you are the best.

Question Number : 167 Question Id : 4050366412 Question Type : MCQ Option Shuffling : Yes Display Question Number : Yes Is Question Mandatory : No Single Line Question Option : No Option Orientation : Vertical Correct Marks : 4 Wrong Marks : 1

आप अपनी कार्यक्षमता के बावजूद कभी भी लाइमलाइट अथवा फोकस में नहीं रहें, आप क्या करेंगे ?

Options :

40503623315. अपने कार्य-निष्पादन स्तर को छोटा कर दें।
40503623316. कार्य करते रहें और पहचान मिलने के क्षण का इंतजार करें।
40503623317. अपने शिकायतों के बारे में खामोश रहें।
40503623318. अपनी कार्यक्षमताओं का खुले तौर पर बखान करें और घोषित करें कि मैं सर्वोत्तम हूँ।

Question Number : 168 Question Id : 4050366413 Question Type : MCQ Option Shuffling : Yes Display Question Number : Yes Is Question Mandatory : No Single Line Question Option : No Option Orientation : Vertical Correct Marks : 4 Wrong Marks : 1

A typical airline flight might have about 150 passengers served by 4 flight attendants. Upon getting this information :

Options :

40503623319. You start wondering about the work pressure.
40503623320. Vouch never to work as a flight attendant.
40503623321. You ignore as you are not interested in aviation industry.
40503623322. You wonder how challenging and thrilling the job of a flight attendant must be.

Question Number : 168 Question Id : 4050366413 Question Type : MCQ Option Shuffling : Yes Display Question Number : Yes Is Question Mandatory : No Single Line Question Option : No Option Orientation : Vertical

Correct Marks : 4 Wrong Marks : 1

एक ठेठ एयरलाइंस फ्लाइट में चार फ्लाईट अटैन्डैन्ट के द्वारा करीब 150 यात्रियों को सर्व किया गया। इस सूचना के मिलने पर :

Options :

40503623319. कार्य दबाव के बारे में सुनकर आप आश्चर्यचकित हो सकते हैं।

40503623320. फ्लाईट अटैन्डैट नहीं बनने की कसम खाता हूँ।

40503623321. आप अनदेखा करते हैं जैसे कि आप विमानन उद्योग में नहीं हैं।

40503623322. आप आश्चर्य करेंगे कि एक फ्लाईट अटैण्डेंट का जॉब कितना चेतावनीपूर्ण एवं रोमांचक होता है।

Question Number : 169 Question Id : 4050366414 Question Type : MCQ Option Shuffling : Yes Display Question Number : Yes Is Question Mandatory : No Single Line Question Option : No Option Orientation : Vertical

Correct Marks : 4 Wrong Marks : 1

Your supervisor repeatedly criticizes you in front of your subordinates. You feel insulted. You would :

Options :

40503623323. Speak to other colleagues regarding this and consider leaving the job.

40503623324. Ignore the situation but feel very angry and hurt by his words.

40503623325. Hit back harshly and make him gulp his own words.

40503623326. Approach him directly and explain your feelings to him.

Question Number : 169 Question Id : 4050366414 Question Type : MCQ Option Shuffling : Yes Display Question Number : Yes Is Question Mandatory : No Single Line Question Option : No Option Orientation : Vertical

Correct Marks : 4 Wrong Marks : 1

आपका पर्यवेक्षक आपके अधीनस्थों के सम्मुख आपकी बार-बार निन्दा करता है। आप बेइज्जती महसूस करते हैं तब आप :

Options :

40503623323. इसके बारे में अन्य सहकर्मियों से बात करें और जॉब छोड़ने का विचार करें।

40503623324. स्थिति को अनदेखा करें लेकिन उसके शब्दों से क्रोधित और ठेस पहुँचती है।

40503623325. निष्ठुरता से प्रतिकार करें और उसे उसके शब्दों को वापस लेने के लिए मजबूर करें।

उससे सीधे मिलें और अपनी भावनाओं से उसे
40503623326. अवगत कराएँ।

**Question Number : 170 Question Id : 4050366415 Question Type : MCQ Option Shuffling : Yes Display Question Number : Yes Is
Question Mandatory : No Single Line Question Option : No Option Orientation : Vertical**

Correct Marks : 4 Wrong Marks : 1

You have observed lately that one of your
colleague at work place has taken you for
granted and often tries to pass off his
responsibilities to you. You would :

Options :

40503623327. Tolerate for some more time and then
counter fiercely.

40503623328. Shout at him in front of every one.

40503623329. Discuss the matter with him in one
to one mode.

40503623330. Stay normal and ignore, although
you don't like it.

**Question Number : 170 Question Id : 4050366415 Question Type : MCQ Option Shuffling : Yes Display Question Number : Yes Is
Question Mandatory : No Single Line Question Option : No Option Orientation : Vertical**

Correct Marks : 4 Wrong Marks : 1

आपने, हाल ही से यह देखा है कि आपका एक सहकर्मी कार्यस्थल में आपको कोई महत्ता नहीं देता है और प्रायः अपनी जिम्मेदारियों को आप पर थोप देता है आप क्या करेंगे ?

Options :

कुछ और समय तक इसे सहन करें और तब कठोरता से प्रतिकार करें।
40503623327.

सबके सामने उस पर जोर से चिल्लाएँ।
40503623328.

आमने-सामने बैठकर उससे इस बारे में बातचीत करें।
40503623329.

यद्यपि आपको यह पसंद नहीं है तथापि सामान्य एवं अनदेखा करें।
40503623330.

Question Number : 171 Question Id : 4050366416 Question Type : MCQ Option Shuffling : Yes Display Question Number : Yes Is Question Mandatory : No Single Line Question Option : No Option Orientation : Vertical

Correct Marks : 4 Wrong Marks : 1

You accidentally over hear a colleague talking negatively about you to your boss. You would :

Options :

storm-in straight away to deny the charges.
40503623331.

Calmly step in and establish logic for your behaviour and actions.
40503623332.

8/29/2020

40503623333. Start fighting with your colleague in front of the boss.

40503623334. Ignore and walk away.

Question Number : 171 Question Id : 4050366416 Question Type : MCQ Option Shuffling : Yes Display Question Number : Yes Is Question Mandatory : No Single Line Question Option : No Option Orientation : Vertical Correct Marks : 4 Wrong Marks : 1

आपके एक सहकर्मी द्वारा आपके बॉस को चुगली करते हुए आप संयोग से सुन लेते हैं आप क्या करेंगे ?

Options :

40503623331. आरोपों के निराधार होने को पूरा जोर तरीके से कहना।

40503623332. शांति से कमरे में जाकर अपने व्यवहार एवं कार्रवाई का औचित्य स्थापित करें।

40503623333. बॉस के सामने अपने सहकर्मी से लड़ाई शुरू करें।

40503623334. अनदेखा कर निकल जाएँ।

Question Number : 172 Question Id : 4050366417 Question Type : MCQ Option Shuffling : Yes Display Question Number : Yes Is Question Mandatory : No Single Line Question Option : No Option Orientation : Vertical Correct Marks : 4 Wrong Marks : 1

8/29/2020

You have been instructed to do a job by your supervisor. You have not understood a part of the instructions. You would :

Options :

40503623335. Seek clarification again before you commence the job.
40503623336. Plunge into the job and clarify only when stuck.
40503623337. Confidently go ahead without bothering about the consequences of mistake.
40503623338. Keep your supervisor informed that some future clarification may be needed.

Question Number : 172 Question Id : 4050366417 Question Type : MCQ Option Shuffling : Yes Display Question Number : Yes Is Question Mandatory : No Single Line Question Option : No Option Orientation : Vertical Correct Marks : 4 Wrong Marks : 1

आपके पर्यवेक्षक ने आपको एक जॉब करने का निर्देश दिया है आप अनुदेशों के एक माँग को समझ नहीं पाए हैं आप क्या करेंगे ?

Options :

40503623335. जॉब प्रारम्भ करने से पहले पुनःस्पष्टीकरण माँग लें।
40503623336. जॉब में लग जाए और रूक जाने पर ही स्पष्टीकरण लें।

40503623337. पूर्ण विश्वास के साथ आगे बढ़ें और गलतियों के परिणामों की चिन्ता छोड़ दें।

40503623338. पर्यवेक्षक को सूचित करते रहें कि भविष्य में कुछ स्पष्टीकरण की आवश्यकता पड़ सकती है।

Question Number : 173 Question Id : 4050366418 Question Type : MCQ Option Shuffling : Yes Display Question Number : Yes Is Question Mandatory : No Single Line Question Option : No Option Orientation : Vertical Correct Marks : 4 Wrong Marks : 1

You as a class monitor have been asked to select a team for accomplishing a job. You would select students :

Options :

40503623339. Only those who are close to you.

40503623340. Only those who would do something when asked.

40503623341. Only those who are ready to adapt to any situation they may come across.

40503623342. Those who are close to you, those who would do something when asked and those who are ready to adapt to any situation they may come across

8/29/2020

Question Number : 173 Question Id : 4050366418 Question Type : MCQ Option Shuffling : Yes Display Question Number : Yes Is Question Mandatory : No Single Line Question Option : No Option Orientation : Vertical

Correct Marks : 4 Wrong Marks : 1

आपको एक कक्षा मॉनिटर होने के नाते किसी जॉब को पूरा करने हेतु एक टीम का चयन करने के लिए कहा गया है आप उन छात्रों को चुनेंगे :

Options :

40503623339. जो केवल आपसे घनिष्ठ हैं।
40503623340. जो केवल कहने पर, कुछ करने के इच्छुक हों।
40503623341. जो केवल किसी भी स्थितियों में अपने आप ढाल लेते हैं।
40503623342. जो आपसे घनिष्ठ हैं, जो कहने पर, कुछ करने के इच्छुक हों और जो किसी भी स्थितियों में अपने आप ढाल लेते हैं।

Question Number : 174 Question Id : 4050366419 Question Type : MCQ Option Shuffling : Yes Display Question Number : Yes Is Question Mandatory : No Single Line Question Option : No Option Orientation : Vertical

Correct Marks : 4 Wrong Marks : 1

Your friends have invited you for a gathering. You accept that and on returning home you are informed that there is a family get together on the same day. You would :

Options :

40503623343. Flatly refuse to attend the family gathering.

40503623344. Blame your friends for holding the gathering on the same day.

40503623345. Decide to attend none of the functions.

40503623346. Very politely refuse to go to one of the places.

Question Number : 174 Question Id : 4050366419 Question Type : MCQ Option Shuffling : Yes Display Question Number : Yes Is Question Mandatory : No Single Line Question Option : No Option Orientation : Vertical Correct Marks : 4 Wrong Marks : 1

एक मित्र ने आपको एक सभा में आमंत्रित किया है आप उसे स्वीकार करते हैं और सूचित किया गया कि घर वापस आते समय उसी दिन एक पारिवारिक गेट-टुगेदर भी है आप क्या करेंगे ?

Options :

40503623343. सीधा पारिवारिक गेट-टुगेदर में शामिल होने के लिए मना कर देंगे।

40503623344. अपने मित्र को दोष देंगे कि एक ही दिन उसने गेट-टुगेदर रखी है।

40503623345. दोनों स्थानों में न जाने का निर्णय लें।

40503623346. नम्रता से एक स्थान पर जाने से इंकार कर दें।

Question Number : 175 Question Id : 4050366420 Question Type : MCQ Option Shuffling : Yes Display Question Number : Yes Is Question Mandatory : No Single Line Question Option : No Option Orientation : Vertical

Correct Marks : 4 Wrong Marks : 1

Your neighbour's daughter is getting married and on the day of the wedding, a fire breaks out. You would :

Options :

40503623347. Panic and run away.

40503623348. Secure the children and the aged people first before you try to help others.

40503623349. Go to a safe distance and watch what is happening.

40503623350. Come back home and relax.

Question Number : 175 Question Id : 4050366420 Question Type : MCQ Option Shuffling : Yes Display Question Number : Yes Is Question Mandatory : No Single Line Question Option : No Option Orientation : Vertical

Correct Marks : 4 Wrong Marks : 1

आपके पड़ोसी की लड़की की शादी है और विवाह के दिन अचानक आग लग जाती है आप :

Options :

40503623347. घबराकर भाग जाएंगे।

40503623348. अन्यो की सहायता करने से पहले बच्चों एवं बुजुर्गों को सुरक्षित करें।

40503623349. एक सुरक्षित दूरी पर जाकर स्थिति पर नज़र रखें।

40503623350. घर वापस आएँ और चैन की साँस लें।

Question Number : 176 Question Id : 4050366421 Question Type : MCQ Option Shuffling : Yes Display Question Number : Yes Is Question Mandatory : No Single Line Question Option : No Option Orientation : Vertical Correct Marks : 4 Wrong Marks : 1

You were going through your younger brother's maths exam copy which was checked and returned by the class teacher. You noticed a correct answer marked wrong. You would :

Options :

40503623351. Straight away place a written complaint to the principal of the school.

40503623352. Blame your brother rudely saying that he should have taken it to the concerned teacher.

40503623353. Go and speak to the concerned teacher yourself without creating a fuss.

40503623354. Put up a quarrel with the concerned teacher.

Question Number : 176 Question Id : 4050366421 Question Type : MCQ Option Shuffling : Yes Display Question Number : Yes Is

Question Mandatory : No Single Line Question Option : No Option Orientation : Vertical

Correct Marks : 4 Wrong Marks : 1

आप अपने छोटे भाई की गणित परीक्षा प्रति को देख रहे हैं जिसे कक्षा अध्यापक ने जाँच कर वापस किया है आप देखते हैं कि एक सही उत्तर को गलत बताया गया है आप :

Options :

40503623351. विद्यालय के प्रधानाचार्य को सीधे एक लिखित शिकायत भेज दें।

40503623352. अपने भाई को दोष दें कि उसने संबंधित अध्यापक से इसके बारे में कहना था।

40503623353. बिना तकरार के स्वयं संबंधित अध्यापक के पास जाएँ और बात करें।

40503623354. संबंधित अध्यापक के साथ झगड़ा करें।

Question Number : 177 Question Id : 4050366422 Question Type : MCQ Option Shuffling : Yes Display Question Number : Yes Is

Question Mandatory : No Single Line Question Option : No Option Orientation : Vertical

Correct Marks : 4 Wrong Marks : 1

How would you ensure that you become the focal point in a group discussion ?

Options :

40503623355. By aggressive gestures and words.

40503623356. Logical talking with appropriate humour.

40503623357. Snubbing others while they want to speak.

40503623358. Trying to stop aggressive outburst of others.

Question Number : 177 Question Id : 4050366422 Question Type : MCQ Option Shuffling : Yes Display Question Number : Yes Is Question Mandatory : No Single Line Question Option : No Option Orientation : Vertical

Correct Marks : 4 Wrong Marks : 1

आप यह कैसे सुनिश्चित करेंगे कि आप एक समूह परिचर्चा में मुख्य बिन्दु बन गए हैं?

Options :

40503623355. उत्साही हाव-भाव व्यक्त कर

40503623356. उचित सरसता के साथ तर्कपूर्ण प्रस्तुति देकर

40503623357. अन्यो के बोलने में इच्छुक होने पर उन्हें डाटने से।

40503623358. अन्यो के उत्साही बातों को बंद करने की कोशिश।

Question Number : 178 Question Id : 4050366423 Question Type : MCQ Option Shuffling : Yes Display Question Number : Yes Is Question Mandatory : No Single Line Question Option : No Option Orientation : Vertical

Correct Marks : 4 Wrong Marks : 1

The welfare society of your locality is organizing a Blood Donation Camp You would :

Options :

8/29/2020

40503623359. Express only verbal desire to support such an initiative.

40503623360. Refrain from going to the venue

40503623361. Get irritated as you do not have time for such activities.

40503623362. Show full enthusiasm and ensure that you are present on the day of the event.

Question Number : 178 Question Id : 4050366423 Question Type : MCQ Option Shuffling : Yes Display Question Number : Yes Is Question Mandatory : No Single Line Question Option : No Option Orientation : Vertical

Correct Marks : 4 Wrong Marks : 1

आपके इलाके की कल्याण सोसाइटी एक रक्तदान शिविर आयोजित कर रही है :

Options :

40503623359. आप इस अभियान को केवल मौखिक विचारों से सहयोग प्रकट करना।

40503623360. स्थल पर नहीं जाना।

40503623361. क्रोधित हो जाए कि आपके पास ऐसे कार्यकलापों के लिए कोई समय नहीं है।

40503623362. उत्साहित रहे और सुनिश्चित करें कि आयोजन के दिन वहाँ आप उपस्थित रहें।

Question Number : 179 Question Id : 4050366424 Question Type : MCQ Option Shuffling : Yes Display Question Number : Yes Is Question Mandatory : No Single Line Question Option : No Option Orientation : Vertical

Correct Marks : 4 Wrong Marks : 1

Which of the following is not a part of a well groomed individual ?

Options :

40503623363. Streaked hair

40503623364. Well kept nails

40503623365. Ironed shirt

40503623366. Formal shoes

Question Number : 179 Question Id : 4050366424 Question Type : MCQ Option Shuffling : Yes Display Question Number : Yes Is Question Mandatory : No Single Line Question Option : No Option Orientation : Vertical

Correct Marks : 4 Wrong Marks : 1

निम्नलिखित में से कौन सा एक सुसज्जित व्यक्ति का भाग नहीं है ?

Options :

40503623363. धारियों वाले बाल

40503623364. अच्छे तरीके से रखे गये नाखून

40503623365. इस्तरी की हुई कमीज

40503623366. यथानियम जूते

Question Number : 180 Question Id : 4050366425 Question Type : MCQ Option Shuffling : Yes Display Question Number : Yes Is Question Mandatory : No Single Line Question Option : No Option Orientation : Vertical

Correct Marks : 4 Wrong Marks : 1

Two of your close friends are having a strained relationship. You would :

Options :

40503623367. Leave them to handle the situation on their own.

40503623368. Allow time to naturally heal up the relationship.

40503623369. Take initiative and try to find out the root cause of the strained relationship.

40503623370. Sever your friendship with both of them.

Question Number : 180 Question Id : 4050366425 Question Type : MCQ Option Shuffling : Yes Display Question Number : Yes Is Question Mandatory : No Single Line Question Option : No Option Orientation : Vertical

Correct Marks : 4 Wrong Marks : 1

आपके दो गहरे मित्रों के मध्य बिगड़े संबंध है, आप क्या करेंगे ?

Options :

40503623367. स्थिति को संभालने हेतु उन पर छोड़ दें।

40503623368. संबंध में ठीक होने के लिए स्वाभाविक समय दें।

40503623369. कोशिश करें और बिगड़े संबंधों की मूल जड़ को ज्ञात करने की कोशिश करें।

40503623370. दोनों के साथ अपने संबंध तोड़ लें।

Question Number : 181 Question Id : 4050366426 Question Type : MCQ Option Shuffling : Yes Display Question Number : Yes Is Question Mandatory : No Single Line Question Option : No Option Orientation : Vertical Correct Marks : 4 Wrong Marks : 1

If your batchmate confides his secrets, you would :

Options :

40503623371. Use the information shared to your advantage.

40503623372. Tell them to few of your other friends.

40503623373. Discuss them with your parents.

40503623374. Discuss the secrets only with the batchmate, if required.

Question Number : 181 Question Id : 4050366426 Question Type : MCQ Option Shuffling : Yes Display Question Number : Yes Is Question Mandatory : No Single Line Question Option : No Option Orientation : Vertical Correct Marks : 4 Wrong Marks : 1

यदि आपका बैचमेट अपनी गोपनीय बातें आपको बताता है तो :

Options :

40503623371. अपने फायदे के लिए उस सूचना का उपयोग करें।
40503623372. उन्हें अपने अन्य मित्रों के साथ शेयर करें।
40503623373. उनकी अपने माता-पिता के साथ चर्चा करें।
40503623374. यदि आवश्यक हो तो इन गोपनीय बातों को बैचमेट के साथ चर्चा करें।

Question Number : 182 Question Id : 4050366427 Question Type : MCQ Option Shuffling : Yes Display Question Number : Yes Is Question Mandatory : No Single Line Question Option : No Option Orientation : Vertical

Correct Marks : 4 Wrong Marks : 1

A new member joins the cricket team of which you are the captain. A day after his joining, he gives a suggestion to you. You would :

Options :

40503623375. Snap at him, saying that his suggestions are not required at such an early stage of joining.
40503623376. Advice him to understand how the team works.

40503623377. Think about the suggestions and judge their relevance.

40503623378. Listen to it and forget about it.

Question Number : 182 Question Id : 4050366427 Question Type : MCQ Option Shuffling : Yes Display Question Number : Yes Is Question Mandatory : No Single Line Question Option : No Option Orientation : Vertical Correct Marks : 4 Wrong Marks : 1

क्रिकेट टीम में एक नया सदस्य जॉइन करता है, जिसके आप कैप्टन हैं। जॉइन करने के एक दिन बाद, वह आपको एक राय देता है। आप :

Options :

40503623375. उसे फटकार कर कहेंगे कि टीम में जॉइन करने के इस शुरुआती समय में उसकी राय की जरूरत नहीं है।

40503623376. उसे यह समझने की राय दें कि कैसे टीम काम करती है।

40503623377. राय के बारे में सोचें और उसकी संगतता को जाँचें।

40503623378. इसे सुनकर भूल जाएँ।

Question Number : 183 Question Id : 4050366428 Question Type : MCQ Option Shuffling : Yes Display Question Number : Yes Is Question Mandatory : No Single Line Question Option : No Option Orientation : Vertical Correct Marks : 4 Wrong Marks : 1

8/29/2020

You are attending a class and suddenly, your mobile phone rings loudly. You would :

Options :

40503623379. Try to hide so that it would be difficult to locate the source.
40503623380. Own up and apologize to the teacher
40503623381. Quickly switch off the mobile phone
40503623382. Give excuses for keeping your phone in the 'ring' mode.

Question Number : 183 Question Id : 4050366428 Question Type : MCQ Option Shuffling : Yes Display Question Number : Yes Is Question Mandatory : No Single Line Question Option : No Option Orientation : Vertical Correct Marks : 4 Wrong Marks : 1

आप कक्षा में बैठे हैं और अचानक आपका मोबाइल जोर से बजने लगता है, आप क्या करेंगे ?

Options :

40503623379. इसे छिपाने की कोशिश करेंगे, जिससे उसके होने की जगह को ढूंढना मुश्किल हो जाए।
40503623380. स्वीकार करें और अध्यापक से माफी मांगें।
40503623381. जल्दी से मोबाइल फोन को स्विच ऑफ करें।
40503623382. अपने मोबाइल को रिंग मोड में रखने के लिए क्षमा याचना करें।

Question Number : 184 Question Id : 4050366429 Question Type : MCQ Option Shuffling : Yes Display Question Number : Yes Is Question Mandatory : No Single Line Question Option : No Option Orientation : Vertical

Correct Marks : 4 Wrong Marks : 1

You are seated in an aircraft at the window seat. A little boy comes and requests you for the window seat and tells you to take the middle seat. You would :

Options :

40503623383. Explain him politely that it is illegal

40503623384. Give up your seat on request

40503623385. Flatly refuse

40503623386. Offer a chocolate and deny the little boy the window seat.

Question Number : 184 Question Id : 4050366429 Question Type : MCQ Option Shuffling : Yes Display Question Number : Yes Is Question Mandatory : No Single Line Question Option : No Option Orientation : Vertical

Correct Marks : 4 Wrong Marks : 1

आप एक एयरक्राफ्ट की विंडो सीट में बैठे हैं। एक छोटा लड़का आकर आप से विंडो सीट के लिए अनुरोध करता है और मीडिल सीट लेने को कहता है। आप :

Options :

40503623383. उसे नम्रता से बताएँ कि यह गैर-कानूनी है।

40503623384. अनुरोध पर अपनी सीट उसे दे दें।

40503623385. साफ मना कर दें।

40503623386. छोटे लड़के को एक चॉकलेट देकर बिंडो सीट देने से इंकार कर दें।

Question Number : 185 Question Id : 4050366430 Question Type : MCQ Option Shuffling : Yes Display Question Number : Yes Is Question Mandatory : No Single Line Question Option : No Option Orientation : Vertical Correct Marks : 4 Wrong Marks : 1

As a team leader, you find one of your team members is not performing up to the mark. You would :

Options :

40503623387. Shout at him in front of everybody.

40503623388. Arrange for a counselling session.

40503623389. Give a poor appraisal to him straight away.

40503623390. Ignore thinking that he would develop with time.

Question Number : 185 Question Id : 4050366430 Question Type : MCQ Option Shuffling : Yes Display Question Number : Yes Is Question Mandatory : No Single Line Question Option : No Option Orientation : Vertical Correct Marks : 4 Wrong Marks : 1

एक टीम लीडर के तौर पर आपको ज्ञात होता है कि, आपका एक टीम सदस्य लक्ष्य के अनुरूप कार्य नहीं कर रहा है। आप :

8/29/2020

Options :

40503623387. सबके सामने उस पर चिल्लाएँगे।
40503623388. एक परामर्श सत्र की व्यवस्था करेंगे।
40503623389. उसको सीधे खराब मूल्यांकन देंगे।
40503623390. यह समझकर अनदेखा करेंगे कि, वह समय के साथ विकसित होगा।

Question Number : 186 Question Id : 4050366431 Question Type : MCQ Option Shuffling : Yes Display Question Number : Yes Is Question Mandatory : No Single Line Question Option : No Option Orientation : Vertical

Correct Marks : 4 Wrong Marks : 1

Your manager calls you in his cabin and points out some deficiencies in your performance. You would :

Options :

40503623391. Consider the manager as 'over analytical'.
40503623392. Consider the manager as a person who wants you to improve.
40503623393. Consider the manager as a 'dominating' person.
40503623394. Listen and judge nothing.

8/29/2020

Question Number : 186 Question Id : 4050366431 Question Type : MCQ Option Shuffling : Yes Display Question Number : Yes Is Question Mandatory : No Single Line Question Option : No Option Orientation : Vertical

Correct Marks : 4 Wrong Marks : 1

आपका प्रबंधक आपको केबिन में बुलाकर आपके कार्य-निष्पादन की कमियों की जानकारी देता है। आप :

Options :

40503623391. प्रबंधक को 'अति विश्लेषणात्मक' मानें।

40503623392. प्रबंधक को एक ऐसा व्यक्ति मानें जो आपमें सुधार चाहता है।

40503623393. प्रबंधक को 'एक तानाशाह' व्यक्ति मानें।

40503623394. सुनें और कुछ विचार नहीं करें।

Question Number : 187 Question Id : 4050366432 Question Type : MCQ Option Shuffling : Yes Display Question Number : Yes Is Question Mandatory : No Single Line Question Option : No Option Orientation : Vertical

Correct Marks : 4 Wrong Marks : 1

Your team has failed to win a final match.

As the captain of the team :

Options :

40503623395. Take all blame on yourself for the defeat.

40503623396. Blame your team members for the defeat.

8/29/2020

40503623397. Try to find out reasons of defeat by discussing with the team members.

40503623398. Resign from the captaincy.

Question Number : 187 Question Id : 4050366432 Question Type : MCQ Option Shuffling : Yes Display Question Number : Yes Is Question Mandatory : No Single Line Question Option : No Option Orientation : Vertical Correct Marks : 4 Wrong Marks : 1

आपकी टीम फाइनल मैच जीतने में असफल रहती है।
टीम के कैप्टन के तौर पर :

Options :

40503623395. हार की सारी जिम्मेदारी अपने पर लें।

40503623396. हार के लिए टीम सदस्यों की निन्दा करें।

40503623397. टीम सदस्यों के साथ चर्चा करके हार के कारणों को ज्ञात करने की कोशिश करें।

40503623398. कैप्टनशिप से इस्तीफा दे दें।

Question Number : 188 Question Id : 4050366433 Question Type : MCQ Option Shuffling : Yes Display Question Number : Yes Is Question Mandatory : No Single Line Question Option : No Option Orientation : Vertical Correct Marks : 4 Wrong Marks : 1

8/29/2020

You are carrying two heavy bags and waiting at a railway station. The train arrives. You struggle with your bags and manage to board the train. Just then, you see an old lady trying hard to lift her bag. You will :

Options :

40503623399. Advice her to call a porter.

40503623400. Try to find your own seat thinking you can help her after wards.

40503623401. Help her to lift her bag.

40503623402. Tell a passer-by to help her.

Question Number : 188 Question Id : 4050366433 Question Type : MCQ Option Shuffling : Yes Display Question Number : Yes Is Question Mandatory : No Single Line Question Option : No Option Orientation : Vertical

Correct Marks : 4 Wrong Marks : 1

आप दो भारी बैग लेकर रेलवे स्टेशन पर गाड़ी का इंतजार कर रहे हैं। ट्रेन आती है। आप अपने बैगों के साथ धक्कामुक्की कर ट्रेन में चढ़ जाते हैं। इसी समय एक बुढ़िया अपने बैगों को उठाकर ट्रेन में चढ़ने की कोशिश कर रही है। आप :

Options :

40503623399. उसे पोर्टर बुलाने के लिए कहेंगे।

40503623400. अपनी सीट खोजें और सोचें कि मैं उसकी बाद में सहायता कर दूंगा।

40503623401. बैग को उठाने में उसकी सहायता करें।

40503623402. आस-पास वाले को कहें कि वह उसकी सहायता करें।

Question Number : 189 Question Id : 4050366434 Question Type : MCQ Option Shuffling : Yes Display Question Number : Yes Is Question Mandatory : No Single Line Question Option : No Option Orientation : Vertical Correct Marks : 4 Wrong Marks : 1

You are in a crowded railway station. Suddenly you spot a little girl all alone and looking confused. You would :

Options :

40503623403. Hand her over to the Railway Police for further help.

40503623404. Ask her if she is lost and ask her to look for her parents or relatives.

40503623405. Take no action.

40503623406. Take her to your house for further assistance.

Question Number : 189 Question Id : 4050366434 Question Type : MCQ Option Shuffling : Yes Display Question Number : Yes Is Question Mandatory : No Single Line Question Option : No Option Orientation : Vertical Correct Marks : 4 Wrong Marks : 1

8/29/2020

आप एक भीड़भाड़ वाले रेलवे स्टेशन में हैं। अचानक आप एक छोटी लड़की अकेले में देखते हैं, जो परेशानी में है। आप क्या करेंगे?

Options :

40503623403. उसे आगे की सहायता के लिए रेलवे पुलिस को सौंप दें।

40503623404. उससे पूछें कि क्या वह खो गई है और उसे अपने माता-पिता अथवा संबंधियों को ढूंढने को कहें।

40503623405. कोई कार्रवाई न करें।

40503623406. आगे की सहायता के लिए उसे अपने घर ले जाएँ।

Question Number : 190 Question Id : 4050366435 Question Type : MCQ Option Shuffling : Yes Display Question Number : Yes Is Question Mandatory : No Single Line Question Option : No Option Orientation : Vertical

Correct Marks : 4 Wrong Marks : 1

You have visited your uncle's place. At the middle of the night your uncle suffers a 'heart attack'. You will :

Options :

40503623407. Ignore and go back to sleep.

40503623408. Wake up immediately and call for an ambulance.

40503623409. Google some medicines for him.

40503623410. Wait till somebody instructs you for some action.

Question Number : 190 Question Id : 4050366435 Question Type : MCQ Option Shuffling : Yes Display Question Number : Yes Is Question Mandatory : No Single Line Question Option : No Option Orientation : Vertical Correct Marks : 4 Wrong Marks : 1

आप अपने चाचा जी के घर गए थे। मध्य रात्रि आपके चाचा को हृदयाघात आ जाता है। आप क्या करेंगे?

Options :

40503623407. अनदेखी करें और फिर सो जाएँ।

40503623408. जल्दी उठे और एंबुलेंस मंगाएँ।

40503623409. उसके लिए कुछ दवाइयों के लिए गुगल में सर्च करें।

40503623410. तब तक इंतजार करें जब तक कोई आपको कुछ कार्रवाई करने का निर्देश देता है।

Question Number : 191 Question Id : 4050366436 Question Type : MCQ Option Shuffling : Yes Display Question Number : Yes Is Question Mandatory : No Single Line Question Option : No Option Orientation : Vertical Correct Marks : 4 Wrong Marks : 1

You have visited a place of tourist interest. You see a group of people littering on the road. You would :

Options :

40503623411. Politely tell them that there is a dustbin nearby.
40503623412. Shout at them for such a behaviour.
40503623413. Express your displeasure with a stern look.
40503623414. Ignore and walk away.

Question Number : 191 Question Id : 4050366436 Question Type : MCQ Option Shuffling : Yes Display Question Number : Yes Is Question Mandatory : No Single Line Question Option : No Option Orientation : Vertical

Correct Marks : 4 Wrong Marks : 1

आप एक पर्यटक स्थान में गए हैं। आप देखते हैं कि व्यक्तियों का एक समूह सड़क में गंदगी फैला रहे हैं।

आप :

Options :

40503623411. विनम्रता से उन्हें कहें कि नजदीक ही एक डस्टबिन है।
40503623412. ऐसे व्यवहार के लिए उन पर चिल्लाएँ।
40503623413. कठोर दृष्टि से अपना असंतोष उन्हें व्यक्त करें।
40503623414. अनदेखा कर आगे बढ़ जाएँ।

Question Number : 192 Question Id : 4050366437 Question Type : MCQ Option Shuffling : Yes Display Question Number : Yes Is

8/29/2020

Question Mandatory : No Single Line Question Option : No Option Orientation : Vertical

Correct Marks : 4 Wrong Marks : 1

A customer has booked a room in your hotel but at the time of arrival, Room is not available. You will :

Options :

40503623415. Take him to your Residence
40503623416. Regret and tell him that hotel is sold out
40503623417. Regret and arrange the room in another comparable category of hotels.
40503623418. Provide him the list of other hotels in the city.

Question Number : 192 Question Id : 4050366437 Question Type : MCQ Option Shuffling : Yes Display Question Number : Yes Is

Question Mandatory : No Single Line Question Option : No Option Orientation : Vertical

Correct Marks : 4 Wrong Marks : 1

एक ग्राहक ने आपके होटल में एक कमरा बुक कराया है, लेकिन उसके आने पर उसे कमरा उपलब्ध नहीं हो पाया। आप क्या करेंगे?

Options :

40503623415. उसे अपने निवास-स्थान ले जाएँगे।
40503623416. खेद व्यक्त कर उसे बताएँगे कि होटल बिक गया है।

40503623417. खेद व्यक्त करते हुए उसके लिए समान श्रेणी का एक कमरा बुक करेंगे।

40503623418. उसे शहर के अन्य होटलों की सूची पकड़ा देंगे।

Question Number : 193 Question Id : 4050366438 Question Type : MCQ Option Shuffling : Yes Display Question Number : Yes Is Question Mandatory : No Single Line Question Option : No Option Orientation : Vertical

Correct Marks : 4 Wrong Marks : 1

A technique that might be used by an active listener is to :

Options :

40503623419. Describe a situation

40503623420. Express anxiety

40503623421. Paraphrase the speakers words

40503623422. Offer a point of view when in conversation

Question Number : 193 Question Id : 4050366438 Question Type : MCQ Option Shuffling : Yes Display Question Number : Yes Is Question Mandatory : No Single Line Question Option : No Option Orientation : Vertical

Correct Marks : 4 Wrong Marks : 1

एक सक्रिय श्रोता द्वारा एक तकनीक का प्रयोग किया जा सकता है :

Options :

8/29/2020

40503623419. स्थिति का वर्णन करें।
40503623420. उत्सुकता व्यक्त करें।
40503623421. वक्ता के शब्दों की व्याख्या करें।
40503623422. परिचर्चा के दौरान एक दृष्टिकोण प्रस्तुत करें।

Question Number : 194 Question Id : 4050366439 Question Type : MCQ Option Shuffling : Yes Display Question Number : Yes Is Question Mandatory : No Single Line Question Option : No Option Orientation : Vertical Correct Marks : 4 Wrong Marks : 1

An old lady, slipped and fell in the lobby of the hotel while walking and she starts shouting, you would :

Options :

40503623423. Tell her its her fault
40503623424. Look for a lady staff to help her
40503623425. Help and make her comfortable
40503623426. Nothing can be done as incident has already taken place.

Question Number : 194 Question Id : 4050366439 Question Type : MCQ Option Shuffling : Yes Display Question Number : Yes Is Question Mandatory : No Single Line Question Option : No Option Orientation : Vertical Correct Marks : 4 Wrong Marks : 1

8/29/2020

एक बूढ़ी औरत होटल की लॉबी में चलते समय फिसलकर गिर जाती है और वह चिल्लाने लगती है। आप क्या करेंगे ?

Options :

40503623423. उसे उसकी गलती बताएँगे।
40503623424. एक महिला स्टाफ को उसकी सहायता के लिए बुलाएँगे।
40503623425. सहायता और उसे आराम दें।
40503623426. घटना पहले ही हो गई है इस लिए कुछ नहीं किया जा सकता है।

Question Number : 195 Question Id : 4050366440 Question Type : MCQ Option Shuffling : Yes Display Question Number : Yes Is Question Mandatory : No Single Line Question Option : No Option Orientation : Vertical Correct Marks : 4 Wrong Marks : 1

A co-worker tells you in confidence that she plans to call in sick while she is actually taking a week's vacations, you will :

Options :

40503623427. Inform the Authorities
40503623428. Ignore the information
40503623429. Advise her to be honest at the work place

40503623430. Take all her responsibilities and encourage her to go for the vacation

Question Number : 195 Question Id : 4050366440 Question Type : MCQ Option Shuffling : Yes Display Question Number : Yes Is Question Mandatory : No Single Line Question Option : No Option Orientation : Vertical

Correct Marks : 4 Wrong Marks : 1

एक सहकर्मी आपको विश्वास में लेकर कहती है कि वह बीमार होने की कॉल कर वास्तव में एक सप्ताह की छुट्टी पर जाना चाहती है। आप :

Options :

40503623427. प्राधिकारियों को सूचित करें।

40503623428. सूचना को अनदेखा करें।

40503623429. उसे राय दें कि वह कार्यक्षेत्र में इमानदार रहें।

40503623430. सभी जवाबदारियाँ लें और उसे छुट्टी पर जाने के लिए प्रोत्साहित करें।

Question Number : 196 Question Id : 4050366441 Question Type : MCQ Option Shuffling : Yes Display Question Number : Yes Is Question Mandatory : No Single Line Question Option : No Option Orientation : Vertical

Correct Marks : 4 Wrong Marks : 1

While travelling in a train, you see a purse lying on the seat next to you, you will :

Options :

40503623431. Pocket the cash and throw the purse.

8/29/2020

40503623432. Ignore as it you did not notice.

40503623433. Change your seat to avoid touching that purse.

40503623434. Take the purse and hand over to Police or Railway officer on duty.

Question Number : 196 Question Id : 4050366441 Question Type : MCQ Option Shuffling : Yes Display Question Number : Yes Is Question Mandatory : No Single Line Question Option : No Option Orientation : Vertical

Correct Marks : 4 Wrong Marks : 1

ट्रेन में यात्रा करते समय आप अपनी सीट के बगल वाली सीट में एक पर्स पड़ा हुआ देखते हैं। आप :

Options :

40503623431. नकदी को जेब में रख लें और पर्स को फेंक दें।

40503623432. अनदेखा करें।

40503623433. पर्स को न छूने हेतु अपनी सीट बदल लें।

40503623434. पर्स को लेकर उसे ड्यूटी पर पुलिस अथवा रेलवे ऑफिसर को सौंप दें।

Question Number : 197 Question Id : 4050366442 Question Type : MCQ Option Shuffling : Yes Display Question Number : Yes Is Question Mandatory : No Single Line Question Option : No Option Orientation : Vertical

Correct Marks : 4 Wrong Marks : 1

8/29/2020

While working as a school teacher, you find a child is unable to understand the lesson always. You will :

Options :

40503623435. Take him to the Principal for strict action.
40503623436. Discuss with the parents of the child and do the needful.
40503623437. Ignore him in the class.
40503623438. Ask him to take private tuitions from you.

Question Number : 197 Question Id : 4050366442 Question Type : MCQ Option Shuffling : Yes Display Question Number : Yes Is Question Mandatory : No Single Line Question Option : No Option Orientation : Vertical

Correct Marks : 4 Wrong Marks : 1

एक विद्यालय अध्यापक के तौर पर कार्य करते हुए आप देखते हैं कि एक बच्चा पाठों को समझने में असमर्थ है। आप :

Options :

40503623435. कठोर कार्रवाई के लिए उसे प्रधानाचार्य के पास ले जाएँ।
40503623436. बच्चे के बारे में माता-पिता से चर्चा करें।
40503623437. उसे कक्षा में अनदेखा करें।

40503623438. उसे आपसे प्राइवेट ट्यूशन लेने को कहें।

Question Number : 198 Question Id : 4050366443 Question Type : MCQ Option Shuffling : Yes Display Question Number : Yes Is Question Mandatory : No Single Line Question Option : No Option Orientation : Vertical Correct Marks : 4 Wrong Marks : 1

What would you do if you realise at the last moment that the assignment you have done is not up to the mark ?

Options :

40503623439. Presume that the teacher may not notice it.

40503623440. Ask the teacher for an extension and promise an up to the mark submission in future.

40503623441. Ignore what teacher says after checking.

40503623442. Give excuses for not doing the task up to the mark.

Question Number : 198 Question Id : 4050366443 Question Type : MCQ Option Shuffling : Yes Display Question Number : Yes Is Question Mandatory : No Single Line Question Option : No Option Orientation : Vertical Correct Marks : 4 Wrong Marks : 1

आप तब क्या करेंगे जब आपको पता लगेगा कि आपके द्वारा दिया गया असाइनमेंट अंतिम समय लक्ष्य के अनुसार नहीं है?

8/29/2020

Options :

40503623439. समझ लेंगे कि अध्यापक ने इसे नोटिस नहीं किया।
40503623440. अध्यापक से एक्सटेंशन एवं भविष्य में समय पर और सही देने की प्रतिज्ञा करेंगे।
40503623441. जाँच के बाद अध्यापक ने क्या कहा उसे अनदेखा करें।
40503623442. टास्क को सही करने के बारे में बहाने दें।

Question Number : 199 Question Id : 4050366444 Question Type : MCQ Option Shuffling : Yes Display Question Number : Yes Is Question Mandatory : No Single Line Question Option : No Option Orientation : Vertical

Correct Marks : 4 Wrong Marks : 1

At your school, your friend asks your opinion about an issue, you will :

Options :

40503623443. Present your honest opinion as you are an expert of that particular subject.
40503623444. Give wrong answer purposely.
40503623445. Rely on other's opinion.
40503623446. Avoid the questions stating that you are busy.

Question Number : 199 Question Id : 4050366444 Question Type : MCQ Option Shuffling : Yes Display Question Number : Yes Is Question Mandatory : No Single Line Question Option : No Option Orientation : Vertical

Correct Marks : 4 Wrong Marks : 1

आपके विद्यालय में आपका एक मित्र किसी मामले में आपकी राय मांगता है। आप :

Options :

40503623443. अपनी राय इमानदारी से दें क्योंकि आप उस विषय के विशेषज्ञ हैं।
40503623444. जान-बूझकर गलत उत्तर दें।
40503623445. दूसरों की राय पर विश्वास करें।
40503623446. आप व्यस्त हैं कहकर प्रश्नों को अनदेखा करें।

Question Number : 200 Question Id : 4050366445 Question Type : MCQ Option Shuffling : Yes Display Question Number : Yes Is Question Mandatory : No Single Line Question Option : No Option Orientation : Vertical

Correct Marks : 4 Wrong Marks : 1

Your boss doesn't pay attention to what you have just said, as he was busy at his computer, you will :

Options :

40503623447. speak loudly to make yourself heard.
40503623448. wait for sometime to talk.

40503623449. leave his office and stop talking in future.

40503623450. tell everyone about this incident.

Question Number : 200 Question Id : 4050366445 Question Type : MCQ Option Shuffling : Yes Display Question Number : Yes Is Question Mandatory : No Single Line Question Option : No Option Orientation : Vertical

Correct Marks : 4 Wrong Marks : 1

आपका बॉस आपने जो अभी कहा उस पर ध्यान नहीं देता है। क्योंकि वह कंप्यूटर में व्यस्त था। आप :

Options :

40503623447. जोर-जोर से बोलेंगे जिससे वह आपको सुन सके।

40503623448. बात-चीत के लिए कुछ समय इंतजार करें।

40503623449. उसके कार्यालय से निकल जाए और भविष्य में उससे बोलना बंद कर दें।

40503623450. इस घटना की सबको सूचना दें।