



Practice, Learn and Achieve
Your Goal with Prepp

RBI Assistant

Mains Answer Key (2020)

Simplifying
Government Exams

 SSC CHSL	 IAS EXAM	 RRB NTPC	 NTSE	 CDS
 SSC CGL	 CBSE UGC NET	 IBPS PO	 NDA	
 SBI PO	 IBPS CLERK	 AFCAT	 SSC JE	 CTET
 CSIR UGC NET	 CAPF	 IBPS RRB		

www.prepp.in

ANSWERS

1. Ans. B.

The corruption at local level can be mitigated by improving monitoring and enforcement from higher levels of government and implementing low-cost, local-level monitoring and enforcement mechanisms. Hence, option B is the correct answer.

2. Ans. A.

Only statement II is true as per the passage. The remaining statements can be corrected as follows:

- The PDS distributes food grains and other goods through over 450,000 fair price shops.
- BPL status is determined by local elected employees.

Hence, option A is the correct answer.

3. Ans. C.

The statement 'leakage in the system is persistently high' implies that the food grains do not reach the intended people. Rather they are sold by the shopkeepers at a higher rate.

It can be inferred from the sentence 'Recent estimates for 2007-2008 place the fraction of grain diverted by shopkeepers and others to the black market at an astounding 43.9% across India, which is actually an improvement over previous years'.

Hence, option C is the correct answer.

4. Ans. B.

The meanings of the words are:
Astounding: surprisingly impressive or notable.

Enforcement: the act of compelling observance of or compliance with a law, rule, or obligation.

Persistence: the fact of continuing in an opinion or course of action in spite of difficulty or opposition.

Perseverance: persistence in doing something despite difficulty or delay in achieving success.

Amazing: causing great surprise or wonder; astonishing.

Imposition: the action or process of imposing something or of being imposed.

Hence, option B is the correct answer.

5. Ans. C.

Out of all the given options, option C is false. It can be corrected as follows:

The PDS is India's largest response to the persistence of malnutrition

6. Ans. A.

As per the findings of the study, one of the implications is that if the number of people entitled to the PDS goods is increased, then a larger number of people will monitor the shopkeeper and punish illegitimate activities.

Hence, Statement I is the cause and statement II is the effect, making option A the correct answer.

7. Ans. B.

The meanings of the words are:

Illegitimate: not authorized by the law; not in accordance with accepted standards or rules.

Illegal: contrary to or forbidden by law, especially criminal law.

Licit: not forbidden; lawful.

Outlawed: made illegal; banned.

Felonious: relating to or involved in crime.

Clandestine: kept secret or done secretly, especially because illicit.

Hence, option B is the correct answer.

8. Ans. E.

The meanings of the given tones are:

Caustic: sarcastic in a scathing and bitter way.

Assertive: having or showing a confident and forceful personality.

Deprecatory: expressing disapproval; disapproving.

Condescending: having or showing an attitude of patronizing superiority.

Informative: providing useful or interesting information.

Since the passage provides information about the role of informal networks in public service delivery, the tone of the passage is informative.

Hence, option C is the correct answer.

9. Ans. A.

The sentence implies that the effects of global climate change can be noticed on the environment.

'Discernible' meaning 'able to be discerned; perceptible' is the apt fit for the blank. Hence, **option A** is the correct answer.

The meanings of the other words are:

- Imminent: about to happen.
- Discreet: careful and prudent in one's speech or actions, especially in order to keep something confidential or to avoid embarrassment.
- Sly: having or showing a cunning and deceitful nature.
- Treacherous: guilty of or involving betrayal or deception.

10. Ans. C.

The sentence enlists the effects of global climate change on the environment. Trees can produce flowers. As a result of global climate change, trees have started producing flowers soon. 'Flowering' meaning 'producing flowers at a specified time or of a specified type' is the apt fit for the blank. Hence, **option C** is the correct answer.

The meanings of the other words are:

- Duplicious: deceitful.
- Heinous: (of a person or wrongful act, especially a crime) utterly odious or wicked.
- Flagrant: (of an action considered wrong or immoral) conspicuously or obviously offensive.
- Vivacious: attractively lively and animated (typically used of a woman).

11. Ans. B.

'Had' is always followed by a past participle of the verb which can be either regular or irregular in form. Hence, the blank must be filled in with the past participle form of 'predict' i.e. 'predicted'.

Therefore, **option B** is the correct answer.

12. Ans. E.

The sentence enlists the effects that the scientists had predicted. The sea levels have risen faster than it was supposed to be. 'Accelerated' meaning 'Moving or progressing faster than is usual' is the apt fit for the blank. Hence, **option E** is the correct answer.

The meanings of the other words are:

- Mischievous: causing or showing a fondness for causing trouble in a playful way.
- Anxious: feeling or showing worry, nervousness, or unease about something with an uncertain outcome.
- Specific: clearly defined or identified.
- Mounted: riding an animal, typically a horse, especially for military or other duty.

13. Ans. D.

A prediction for the next century by IPCC is provided in the sentence. 'Forecasts' meaning 'predicts or estimates (a future event or trend)' is apt fit for the blank. Hence, **option D** is the correct answer.

The meanings of the other words are:

- Despair: loses or be without hope.
- Recall: bring (a fact, event, or situation) back into one's mind; remember.
- Dread: anticipate with great apprehension or fear.
- Surrender: stop resisting to an enemy or opponent and submit to their authority.

14. Ans. A.

The sentence implies that the degree to which the climate change will have effect on the individual will depend on how the environment and people adapt to the change. 'Societal' meaning 'relating to society or social relations' is the apt fit for the blank. Hence, **option A** is the correct answer.

The meanings of the other words are:

- Medical: relating to the science or practice of medicine.
- Forlorn: pitifully sad and abandoned or lonely.
- Pitiful: deserving or arousing pity.
- Nugatory: of no value or importance.

Hence, **option A** is the correct answer.

15. Ans. B.

We use infinitive after 'to'. Hence, the blank must be filled in with 'mitigate'. 'Mitigate' is also in parallel with 'adapt'. Hence, **option B** is the correct answer.

16. Ans. E.

The blank must contain the word that is opposite to 'harmful'. 'Beneficial' meaning 'resulting in good; favourable or advantageous'

is the apt fit for the blank. Hence, **option E** is the correct answer.

The meanings of the other words are:

- Ominous: giving the worrying impression that something bad is going to happen; threateningly inauspicious.
- Infelicitous: unfortunate; inappropriate.
- Lackadaisical: lacking enthusiasm and determination; carelessly lazy.
- Inert: lacking the ability or strength to move.

17. Ans. A.

Emblematic: Symbolic

Of the given options, only 'emblematic' fits the blank appropriately to make a contextually and grammatically correct statement. All the other options are unfit since they either fail to complement the tense of the statement, or are contextually irrelevant.

Thus, option A is the correct answer.

18. Ans. E.

Cheered: Promote good spirit

Of the given options, only 'cheered' fits the blank appropriately to make a contextually and grammatically correct statement. All the other options are unfit since they either fail to complement the tense of the statement, or are contextually irrelevant.

Thus, option E is the correct answer.

19. Ans. D.

Hopelessly (adverb): Without expectation

Of the given options, only 'hopelessly' fits the blank appropriately to make a contextually and grammatically correct statement. All the other options are unfit since they either fail to complement the tense of the statement, or are contextually irrelevant.

Thus, option D is the correct answer.

20. Ans. B.

Dwindled: Decreased, shrunk, or reduced in size greatly

Of the given options, only 'dwindles' fits the blank appropriately to make a contextually and grammatically correct statement. This is because, since the band has already lost its fan following, the verb to fill the blank will be in the past tense to denote an event that has come before the disappearance of the fan base. All the other options are unfit since they either fail to complement the tense of the statement, or are contextually irrelevant.

Thus, option B is the correct answer.

21. Ans. A.

Of the given options, only 'despite' fits the blank appropriately to make a contextually and grammatically correct statement. Since the two parts of the sentence are denoting a contrast between doing something and feeling unwell, the conjunction 'despite' fits best to point it out. All the other options are unfit since they are contextually irrelevant.

Thus, option A is the correct answer.

22. Ans. E.

Part A ends with a decision 'to ground'. Since we are talking about aviation here, the most likely candidate to be grounded is an aircraft. Part E starts with 'all Boeing 737 Max aircraft' which can be grounded. So, A goes with E.

When jets crash, their safety is put 'under question'. But column II doesn't have any options starting with 'question' as part B ends with 'under'. So, B is pair less.

Aeroplanes such as the 737 MAX are operated by airline companies like the Ethiopian Airlines. So, C & F make a pair.

Hence, the correct answer is E.

23. Ans. A.

An iconic campaign, leaving a strong impact in the minds of the viewers is a logical statement. So, logically B pairs up with E.

A doesn't have a pair because it ends with 'to', which needs the verb following it to be in its base form. But none of the options in column II start with a verb in its base form.

The only option without A and B-E has pair is option A. Hence, the correct answer is A.

24. Ans. C.

Part A ends with 'back to the', which means the next part will contain a specific point in history. Both part D & F point towards two events in history, but A requires that time period to act as the object of the

sentence. E uses its event as the subject. So, A & F go together.

Suffragette is defined in part C and continued in D. Thus, C and D form a pair.

E refers to something as 'such a radical thought' which is not present in B. So, they don't form a pair.

Hence, the correct answer is C.

25. Ans. D.

'So', at the end of part A, refers that we would draw a conclusion from the fact that 'our bones become brittle as we grow old'. But no such options are present in column II. So, A doesn't have a pair.

Part C says 'your immune' which means the next word is 'system' as there are only two words related to immune and can belong to us - immunity & immune system. Since, no such option is available in column II, C is pairless.

B can go with either E or F. Hence the correct answer is D.

26. Ans. E.

In the given question A connects with D and B connects with E to make meaningful and grammatically correct sentences. D completes the idea given in A, that before starting to work for an employer his/her shortcomings must be discovered. F tells that architectures or algorithms follow a specific pattern. B and E if joined makes a contextually correct sentence but there is an error in sentence E which will make the sentence grammatically incorrect. The usage of 'has' in the starting of

the sentence makes sentence E incorrect. The subject in sentence B "levels" is plural. Thus "has" must be replaced with "have" to make the sentence grammatically correct.

Hence, option E is the correct option.

27. Ans. D.

Words placed at 1 and 4 needs to be exchanged.

Heralded: Announced

Commenced: Began

It is customary for Royals to be heralded before arrival. Similarly, a court commences, or begins, once the presider arrives. Thus, 'heralded' and 'commenced' needs to be exchanged to make the sentence contextually and grammatically correct.

Thus, option D is the correct answer.

28. Ans. B.

Words placed at 1 and 2 needs to be exchanged

Hankering: Craving

Given the context of the sentence, the syntax should be the verb preceding the noun, with a preposition qualifying their relation. Thus, 'hankering' will precede 'chocolates' to make the sentence grammatically correct.

Thus, option B is the correct answer.

29. Ans. A.

Words placed at 1 and 4 needs to be exchanged.

A pronoun being followed immediately by a noun doesn't make contextual sense. Similarly,

'hounded' is a verb, and does not denote a place someone can take a trip to. To make contextual sense, the two words need to be exchanged.

Thus, option A is the correct answer.

30. Ans. C.

Words placed at 1 and 3 needs to be exchanged.

The noun 'soldiers' needs an adjective to be qualified. Similarly, the noun 'flag' needs a verb to qualify its purpose. This needs the words placed at 1 and 3 to be exchanged so that the sentence can become contextually and grammatically correct.

Thus, option C is the correct answer.

31. Ans. E.

The sentence is grammatically and contextually correct, and cannot be improved further.

Thus, option E is the correct answer.

32. Ans. E.

Statement D provides the paragraph with a subject of discussion, a 15-year old scientist and inventor being named Time magazine's first 'kid of the year'. Thus, it needs to be the first statement of the paragraph. Since Statement D provides the information that the 15 year old is receiving an accolade, 'kid of the year', the following sentences should outline the achievements that entitle her to the accolade. This has been done by statements A and B. But since statement A has the

word 'also' in it, something else, in this case, statement B, must have come before in the arrangement. Thus, the correct order would be statement B, followed by statement A. Statement E outlines her objective, and should thus be fourth in the sequence. Of the remaining statements, the fifth should outline the selection process, while the sixth speaks about the final award ceremony. Thus, the order will be statement C, followed by statement F.

Thus, the passage, after rearrangement, will be in the order DBAECF.

From the rearrangement it is clear that statement E will be the fourth statement.

Thus, option E is the correct answer.

33. Ans. B.

Statement D provides the paragraph with a subject of discussion, a 15-year old scientist and inventor being named Time magazine's first 'kid of the year'. Thus, it needs to be the first statement of the paragraph. Since Statement D provides the information that the 15 year old is receiving an accolade, 'kid of the year', the following sentences should outline the achievements that entitle her to the accolade. This has been done by statements A and B. But since statement A has the word 'also' in it, something else, in this case, statement B, must have come before in the arrangement. Thus, the correct order would be

statement B, followed by statement A. Statement E outlines her objective, and should thus be fourth in the sequence. Of the remaining statements, the fifth should outline the selection process, while the sixth speaks about the final award ceremony. Thus, the order will be statement C, followed by statement F.

Thus, the passage, after rearrangement, will be in the order DBAECF.

From the rearrangement it is clear that statement D will be the first statement.

Thus, option B is the correct answer.

34. Ans. D.

Statement D provides the paragraph with a subject of discussion, a 15-year old scientist and inventor being named Time magazine's first 'kid of the year'. Thus, it needs to be the first statement of the paragraph. Since Statement D provides the information that the 15 year old is receiving an accolade, 'kid of the year', the following sentences should outline the achievements that entitle her to the accolade. This has been done by statements A and B. But since statement A has the word 'also' in it, something else, in this case, statement B, must have come before in the arrangement. Thus, the correct order would be statement B, followed by statement A. Statement E outlines her objective, and should thus be fourth

in the sequence. Of the remaining statements, the fifth should outline the selection process, while the sixth speaks about the final award ceremony. Thus, the order will be statement C, followed by statement F.

Thus, the passage, after rearrangement, will be in the order DBAECF.

From the rearrangement it is clear that statement A will be the third statement.

Thus, option D is the correct answer.

35. Ans. C.

Statement D provides the paragraph with a subject of discussion, a 15-year old scientist and inventor being named Time magazine's first 'kid of the year'. Thus, it needs to be the first statement of the paragraph. Since Statement D provides the information that the 15 year old is receiving an accolade, 'kid of the year', the following sentences should outline the achievements that entitle her to the accolade. This has been done by statements A and B. But since statement A has the word 'also' in it, something else, in this case, statement B, must have come before in the arrangement. Thus, the correct order would be statement B, followed by statement A. Statement E outlines her objective, and should thus be fourth in the sequence. Of the remaining statements, the fifth should outline the selection process, while the

sixth speaks about the final award ceremony. Thus, the order will be statement C, followed by statement F.

Thus, the passage, after rearrangement, will be in the order DBAECF.

From the rearrangement it is clear that statement B will be the second statement.

Thus, option C is the correct answer.

36. Ans. B.

Statement D provides the paragraph with a subject of discussion, a 15-year old scientist and inventor being named Time magazine's first 'kid of the year'. Thus, it needs to be the first statement of the paragraph. Since Statement D provides the information that the 15 year old is receiving an accolade, 'kid of the year', the following sentences should outline the achievements that entitle her to the accolade. This has been done by statements A and B. But since statement A has the word 'also' in it, something else, in this case, statement B, must have come before in the arrangement. Thus, the correct order would be statement B, followed by statement A. Statement E outlines her objective, and should thus be fourth in the sequence. Of the remaining statements, the fifth should outline the selection process, while the sixth speaks about the final award ceremony. Thus, the order will be

statement C, followed by statement F.

Thus, the passage, after rearrangement, will be in the order DBAECF.

From the rearrangement it is clear that statement F will be the last statement.

Thus, option B is the correct answer.

37. Ans. A.

Statement D provides the paragraph with a subject of discussion, a 15-year old scientist and inventor being named Time magazine's first 'kid of the year'. Thus, it needs to be the first statement of the paragraph. Since Statement D provides the information that the 15 year old is receiving an accolade, 'kid of the year', the following sentences should outline the achievements that entitle her to the accolade. This has been done by statements A and B. But since statement A has the word 'also' in it, something else, in this case, statement B, must have come before in the arrangement. Thus, the correct order would be statement B, followed by statement A. Statement E outlines her objective, and should thus be fourth in the sequence. Of the remaining statements, the fifth should outline the selection process, while the sixth speaks about the final award ceremony. Thus, the order will be statement C, followed by statement F.

Thus, the passage, after rearrangement, will be in the order DBAECF.

From the rearrangement it is clear that statement C will be the fifth statement.

Thus, option A is the correct answer.

38. Ans. D.

The idiom 'head over heels' means 'madly in love'. It should be replaced with 'dry run' meaning 'a rehearsal of a performance or procedure before the real one' to form a contextually correct sentence.

Hence, **option D** is the correct answer.

39. Ans. A.

'Loose cannons' mean 'an unpredictable or uncontrolled person who is liable to cause unintentional damage'. The emboldened phrase should be replaced with 'know the ropes' meaning 'have experience of the appropriate procedures' to form a contextually correct sentence.

Hence, **option A** is the correct answer.

40. Ans. B.

The idiom 'over the top' means 'to an excessive or exaggerated degree'. It should be replaced with 'off the hook' meaning 'no longer in difficulty or trouble' to form a contextually correct sentence.

Hence, **option B** is the correct answer.

41. Ans. D.

Let the marked price of product S at shop A = Rs. $100a$, then

$$100a \times \left(1 - \frac{20}{100}\right) \left(1 - \frac{20}{100}\right) = 450$$

$$\times \left(1 + \frac{28}{100}\right)$$

$$\Rightarrow 64a = 576$$

$$\Rightarrow a = 9$$

Hence, the marked price of product S at shop A = $100a = 100 \times 9 = \text{Rs. } 900$

42. Ans. B.

$$\text{Required difference} = 360 \times \left(\frac{25}{100} - \frac{22.5}{100}\right) = 360 \times \frac{2.5}{100} = \text{Rs. } 9$$

43. Ans. D.

Selling price of product P at shop B = $240 \times \left(1 + \frac{10}{100}\right) = \text{Rs. } 264$

Selling price of product R at shop A = $300 \times \left(1 + \frac{16}{100}\right) = \text{Rs. } 348$

Discount offered = Marked Price - Selling Price

Discount offered on product P at shop B = $528 - 264 = \text{Rs. } 264$

Discount offered on product R at shop A = $435 - 348 = \text{Rs. } 87$

Hence, the required difference = $264 - 87 = \text{Rs. } 177$.

44. Ans. D.

Profit on product T at shop A = $78 + 16\% \text{ of } 450 = 78 + 72 = \text{Rs. } 150$

Cost price of product T = $240 + 25\% \text{ of } 240 = 240 + 60 = \text{Rs. } 300$

Hence, the required percentage = $\frac{150}{300} \times 100 = 50\%$

300

45. Ans. C.

Selling price of product P at shop A = $240 \times \left(1 + \frac{20}{100}\right) = \text{Rs. } 288$

Selling price of product Q at shop A = $360 \times \left(1 + \frac{22.5}{100}\right) = \text{Rs. } 441$

Selling price of product R at shop A = $300 \times \left(1 + \frac{16}{100}\right) = \text{Rs. } 348$

Selling price of product S at shop A = $450 \times \left(1 + \frac{28}{100}\right) = \text{Rs. } 576$

Required average selling price = $\frac{288 + 441 + 348 + 576}{4} \approx \text{Rs. } 410$

4

46. Ans. D.

Statement I:

Let initial quantity of water be $4x$ Litres and initial quantity of milk = $7x$ Litres

$$\text{So, } 4x + 7x + 4 = 136$$

$$\Rightarrow x = 12$$

Initial quantity of milk = $7 \times 12 = 84$ Litres

Initial quantity of water = $4 \times 12 = 48$ Litres

Hence, statement I alone is sufficient to answer the question.

Statement II:

For percentage-distribution to become double, same quantity as given in the question to be replaced, needs to be present initially.

Initial quantity of water = 48L

Hence, statement II alone is sufficient to answer the question.

Hence, the answer is option D.

47. Ans. E.

Statement I:

Let speed of the boat in still water and speed of the stream be x and y km/hr respectively

And let the upstream and downstream distance travelled be d_1 and d_2 km respectively.

$$\text{So, } \frac{d_1}{x-y} = \frac{d_2}{x+y} = 4$$

$$d_1 = 4(x - y) \dots(1)$$

$$d_2 = 4(x + y) \dots(2)$$

$$\text{And, } d_1(x + y) = d_2(x - y) \dots(3)$$

Hence, statement I alone is not sufficient to answer the question.

Statement II:

$$2d_1 = d_2 \dots(4)$$

No further information can be derived. So, statement II alone is not sufficient to answer the question.

From statement I and II together:

Putting value of eq. (4) in eq. (3), we get

$$d_1(x + y) = 2d_1(x - y)$$

$$\Rightarrow x + y = 2(x - y)$$

$$\Rightarrow x = 3y \dots(5)$$

Putting value of eq. (5) in eq. (1) and (2), we get

$$d_1 = 8y \text{ and } d_2 = 16y.$$

Statement I and II together are not sufficient to answer the question.

Hence, the answer is option E.

48. Ans. A.

Let time taken by pipes A, B and C alone is a, b and c hours, respectively.

Statement I:

$$\frac{1}{b} + \frac{1}{c} = \frac{1}{4} \dots\dots(1)$$

$$\frac{1}{a} + \frac{1}{b} + \frac{1}{c} = \frac{1}{3} \dots\dots(2)$$

$$\text{Equation (2) - (1)}$$

$$\frac{1}{a} = \frac{1}{3} - \frac{1}{4} = \frac{1}{12}$$

$$\Rightarrow a = 12 \text{ hours}$$

Statement I alone is sufficient to answer the question.

Statement II:

$$\frac{1}{a} + \frac{1}{c} = \frac{17}{60} \dots\dots(1)$$

$$\frac{1}{a} + \frac{1}{b} = \frac{2}{15} \dots\dots(2)$$

$$\text{Equation (1) - (2)}$$

$$\frac{1}{c} - \frac{1}{b} = \frac{3}{20}$$

Statement II alone is not sufficient to answer the question.

Hence, the answer is option A.

49. Ans. B.

Let time taken by A, B and C to complete the work alone be A, B and C days.

Statement I:

$$A = 2B$$

$$C = 3B$$

No further information can be derived. Hence, statement I alone is not sufficient to answer the question.

Statement II:

$$\frac{1}{A} + \frac{1}{B} = \frac{3}{60 \times 5} = \frac{1}{100}$$

$$\frac{1}{2C} = \frac{1}{200}$$

$$\Rightarrow C = 100$$

$$\frac{1}{A} + \frac{1}{B} + \frac{1}{C} = \frac{1}{100} + \frac{1}{100} = \frac{1}{50}$$

A, B and C can complete the work in 50 days.

Hence, statement II alone is sufficient to answer the question.

Hence, the answer is option B.

50. Ans. C.

Let the discount, cost price, selling price and marked price be Rs. d, x, y and z respectively.

Statement I:

$$y = 1.5x$$

No further information can be derived. Hence, statement I alone is not sufficient to answer the question.

Statement II:

$$d = 200$$

$$10\% \text{ of } z = 200$$

$$\Rightarrow z = 2000$$

$$y = 2000 - 200 = 1800$$

No further information can be derived. Hence, statement II alone is not sufficient to answer the question.

Statement I and II together:

$$y = 1800$$

$$\text{And } y = 1.5x = 1800$$

$$\Rightarrow x = \text{Rs. } 1200$$

Hence, statement I and II together are needed to answer the question.

Hence, the answer is option C.

51. Ans. C.

Let Rohan can do "r" units of work per day and let Mohan can do "m" units of work per day, then

$$\text{Total work} = 17r + 17m \dots\dots (i)$$

According to the question

After working for 7 days Rohan left the work and Mohan completed rest of the work in 15 more days

So, Mohan worked for a total of $(15 + 7 = 22 \text{ days})$

$$\text{Total work} = 7r + 22m \dots\dots (ii)$$

From equations (i) and (ii), we get

$$17r + 17m = 7r + 22m$$

$$\Rightarrow 10r = 5m$$

$$\Rightarrow 2r = m$$

$$\text{Hence, Mohan's share} = \frac{22m}{(22m + 7r)} \times$$

$$5100 = \frac{44}{(44 + 7)} \times 5100 = \text{Rs. } 4400$$

52. Ans. D.

Let amount of money invested by Ramesh = Rs. P

Interest = 10% p.a. and time = 2 years

$$\text{Amount after 2 years} = P \times \left(1 + \frac{10}{100}\right)^2 = \text{Rs. } 1.21P$$

Rajesh took 20% of this money

So, Ramesh would have been left with 80% of the money and this leftover money is equal to Rs. 11132

$$\text{i.e. } 80\% \text{ of } 1.21P = 11132$$

$$\Rightarrow P = \frac{11132 \times 100}{80 \times 1.21} = \text{Rs. } 11500$$

53. Ans. C.

Let six years ago,

Age of Raman be 5k years and Age of Aman = 8k years

9 years from now,

$$\text{Age of Aman : Raman} = 13 : 10$$

$$\frac{5k + 15}{8k + 15} = \frac{10}{13}$$

$$\Rightarrow 65k + 195 = 80k + 150$$

$$\Rightarrow 15k = 45$$

$$\Rightarrow k = 3$$

So, Present age of Raman = $5k + 6 = 21 \text{ years}$

54. Ans. D.

Total Profit at the end of the year = Rs. 30000

Kajal's share in total profit = 4000

$$+ \frac{30000 - 4000}{2} = \text{Rs. } 17000$$

Badal's share in total profit = 30000
- 17000 = Rs. 13000

20% of 30000 = Rs. 6000

So, ratio of Kajal's and Badal's
investments = (17000 - 6000) :
13000 = 11000 : 13000 = 11 : 13.

55. Ans. E.

Let cost price of 100 gm rice = Rs.
100 and shopkeeper bought 900 gm
rice

Cost price = Rs. 900

Shopkeeper gets $8\frac{1}{3}\%$ more than
the indicated weight

So, he gets $900 + 8\frac{1}{3}\%$ of 900 = 900
+ 75 = 975 gm rice

Marked Price = $975 + 33\frac{1}{3}\%$ of 975
= $975 + 325$ = Rs. 1300

Discount = 10% of 1300 = 130

Selling price = 1300 - 130 = Rs.
1170

So, final profit of shopkeeper =
 $\frac{1170 - 900}{900} \times 100 = 30\%$.

56. Ans. B.

Yearly savings of Ram for the year
2004 = 650000 - 450000 = Rs.
200000

Yearly savings of Ram for the year
2005 = 800000 - 500000 = Rs.
300000

Required answer = $\frac{300000 - 200000}{12} =$

Rs. 8333.33

Hence, the answer is option B.

57. Ans. D.

Yearly savings of Ram for the year
2002 = 700000 - 300000 = Rs.
400000

Monthly income of Ram in the year
2003 = $\frac{600000}{12} =$ Rs. 50000

Required ratio = 400000 : 50000 =
8 : 1

Hence, the answer is option D.

58. Ans. B.

Yearly savings of Ram for the year
2002 = 700000 - 300000 = Rs.
400000

Amount after 3 years from the
savings of year 2002 = $400000 \times$
 $(1.1)^3 =$ Rs. 532400

Yearly savings of Ram for the year
2003 = 600000 - 400000 = Rs.
200000

Yearly savings of Ram for the year
2004 = 650000 - 450000 = Rs.
200000

Yearly savings of Ram for the year
2005 = 800000 - 500000 = Rs.
300000

Required amount = 532400 +
200000 + 200000 + 300000 = Rs.
1232400

Hence, the answer is option B.

59. Ans. A.

Yearly savings of Ram for the year
2006 = $800000 \times 1.25 - 500000 \times$
 $1.2 =$ Rs. 400000

Yearly savings of Ram for the year
2003 = 600000 - 400000 = Rs.
200000

Required percentage =
 $\frac{400000 - 200000}{200000} \times 100 = 100\%$

Hence, the answer is option A.

60. Ans. E.

Yearly savings of Ram for the year
2002 = 700000 - 300000 = Rs.
400000

Yearly savings of Ram for the year 2003 = 600000 - 400000 = Rs. 200000

Yearly savings of Ram for the year 2004 = 650000 - 450000 = Rs. 200000

Yearly savings of Ram for the year 2005 = 800000 - 500000 = Rs. 300000

Yearly savings of Ram for the year 2006 = 300000 × 0.9 = Rs. 270000

Yearly savings of Ram for the year 2007 = 270000 × 0.9 = Rs. 243000

Yearly savings of Ram for the year 2008 = 243000 × 0.9 = Rs. 218700

Yearly savings of Ram for the year 2009 = 218700 × 0.9 = Rs. 196380

Required Average =

$$\frac{400000 + 200000 + 200000 + 300000 + 270000 + 243000 + 218700 + 196380}{8}$$

= Rs. 253510

61. Ans. A.

Let A's efficiency = a units/day and B's efficiency = b units/day, then

C's efficiency = 2b units/day

Total work = 14a + 14b (i)

But, according to the question A worked for 12 days (2 days working alone + 2 days with B + 8 days with C), B worked for 2 days, and C worked for 8 days

So, total work = 12a + 2b + 8 × 2b = 12a + 18b (ii)

From equations (i) and (ii), we get

$$14a + 14b = 12a + 18b$$

$$\Rightarrow 2a = 4b$$

$$\Rightarrow a = 2b$$

$$\text{Required no. of days} = \frac{14a + 14b}{2b} =$$

$$\frac{28b + 14b}{2b} = 21 \text{ days.}$$

62. Ans. D.

Let present age of Virat = 5k years, then

Present age of Rahul = 8k years

10 years hence, Virat's age = (5k + 10) years and Rahul's age = (8k + 10) years

So, according to the question

$$\Rightarrow \frac{5k+10}{8k+10} = \frac{7}{10}$$

$$\Rightarrow 50k + 100 = 56k + 70$$

On solving we get, k = 5

The age of Rahul 15 years from now = (8k + 15) = 8 × 5 + 15 = 55 years.

63. Ans. C.

Let speed of the bike be 4k km/hr and speed of the train be 5k km/hr.

Distance travelled on bike = $\frac{1}{3} \times 420$

$$= 140 \text{ km}$$

So, distance travelled in train = 420 - 140 = 280 km

According to question

$$\frac{280}{5k} = \frac{140}{4k} + 3$$

$$\Rightarrow 56 = 35 + 3k$$

$$\Rightarrow k = \frac{56-35}{3} = 7$$

Hence, the required time = $\frac{140}{4k} =$

$$\frac{140}{28} = 5 \text{ hours}$$

64. Ans. B.

Amount of alcohol in final mixture =

$$\frac{7}{(7+5)} \times 168 = 98 \text{ litres}$$

Amount of water in final mixture = 168 - 98 = 70 litres

Amount of water in initial mixture = 70 litres (Only alcohol was added.

So, quantity of water should have remained unchanged)

Amount of Alcohol in initial mixture
 $= \frac{5}{7} \times 70 = 50$ litres

Let amount of water added = x litres

According to question

$$\frac{(70 + x)}{3} = \frac{50}{2}$$

$$\Rightarrow x = 75 - 70 = 5$$

Thus, the amount of water added =
x = 5 litres.

Hence, option B is correct

65. Ans. B.

Let cost price of 1 pen = Rs. 5x,
then

Marked price of 1 pen = $\frac{5x}{5} \times 8 =$ Rs.

8x

Shopkeeper sold 5 packets of pen
i.e. $5 \times 5 = 25$ in each case

Cost price in each case = $25 \times 5x =$
Rs. 125x

Offer 1: Customer gets a total of 5
packets at the selling price of 4
packets

So, Selling price = $4 \times (5 \times 8x) =$
Rs. 160x

Offer 2: Customer gets discount of
35%

Selling price = $(25 \times 8x)(1 - \frac{35}{100}) =$

Rs. 130x

According to the question:

$$160x - 130x = 48 \times 25$$

$$\Rightarrow x = \frac{1200}{30} = 40$$

Hence the cost price of 1 pen = 5x
= $5 \times 40 =$ Rs. 200.

66. Ans. B.

Examination Q:

Number of aspirants appeared for
prelims = 1500000

Number of aspirants qualified for
mains = $1500000 \times 0.1 = 150000$

Number of aspirants who didn't
qualify for mains = $1500000 -$
 $150000 = 1350000$

Number of aspirants qualified for
GD-PI = X

Number of aspirants who got the
final offer = 0.22X

Number of aspirants who didn't get
the final offer = 0.78X

Number of aspirants who joined the
bank = 1000

Number of aspirants who didn't join
the bank = $0.22X - 1000$

Examination R:

Number of aspirants appeared for
prelims = $1350000 + 150000 \times$
 $0.3333 = 1400000$

Number of aspirants qualified for
mains = $1400000 \times 0.2 = 280000$

Number of aspirants who didn't
qualify for mains = $1400000 -$
 $280000 = 1120000$

Number of aspirants qualified for
GD-PI = X + 15000

Number of aspirants who got the
final offer = $0.22X \times 0.9 = 0.198X$

Number of aspirants who didn't get
the final offer = $0.802X + 15000$

Number of aspirants who didn't join
the bank = $0.22X - 700$

Number of aspirants who joined the
bank = $700 - 0.022X$

Number of aspirants qualified for
mains of Examination R = Number
of aspirants qualified for GD-PI of
Examination Q + 250000

Thus number of aspirants qualified for GD-PI of Examination Q = $280000 - 250000 = 30000 = X$
Required Ratio = $700 - 0.022X : 0.22X - 1000$
 $= 700 - 660 : 6600 - 1000$
 $= 40 : 5600 = 1 : 140$

Hence, the answer is option B.

67. Ans. D.

Examination Q:

Number of aspirants appeared for prelims = 1500000

Number of aspirants qualified for mains = $1500000 \times 0.1 = 150000$

Number of aspirants who didn't qualify for mains = $1500000 - 150000 = 1350000$

Number of aspirants qualified for GD-PI = X

Number of aspirants who got the final offer = $0.22X$

Number of aspirants who didn't get the final offer = $0.78X$

Number of aspirants who joined the bank = 1000

Number of aspirants who didn't join the bank = $0.22X - 1000$

Examination R:

Number of aspirants appeared for prelims = $1350000 + 150000 \times 0.3333 = 1400000$

Number of aspirants qualified for mains = $1400000 \times 0.2 = 280000$

Number of aspirants who didn't qualify for mains = $1400000 - 280000 = 1120000$

Number of aspirants qualified for GD-PI = $X + 15000$

Number of aspirants who got the final offer = $0.22X \times 0.9 = 0.198X$

Number of aspirants who didn't get the final offer = $0.802X + 15000$

Number of aspirants who didn't join the bank = $0.22X - 700$

Number of aspirants who joined the bank = $700 - 0.022X$

Number of aspirants qualified for mains of Examination R = Number of aspirants qualified for GD-PI of Examination Q + 250000

Number of aspirants qualified for GD-PI of Examination Q = $280000 - 250000 = 30000 = X$

Required answer = $0.802X + 15000$
 $= 0.802 \times 30000 + 15000 = 39060$

Hence, the answer is option D.

68. Ans. C.

Examination Q:

Number of aspirants appeared for prelims = 1500000

Number of aspirants qualified for mains = $1500000 \times 0.1 = 150000$

Number of aspirants who didn't qualify for mains = $1500000 - 150000 = 1350000$

Number of aspirants qualified for GD-PI = X

Number of aspirants who got the final offer = $0.22X$

Number of aspirants who didn't get the final offer = $0.78X$

Number of aspirants who joined the bank = 1000

Number of aspirants who didn't join the bank = $0.22X - 1000$

Examination R:

Number of aspirants appeared for prelims = $1350000 + 150000 \times 0.3333 = 1400000$

Number of aspirants qualified for mains = $1400000 \times 0.2 = 280000$
Number of aspirants who didn't qualify for mains = $1400000 - 280000 = 1120000$
Number of aspirants qualified for GD-PI = $X + 15000$
Number of aspirants who got the final offer = $0.22X \times 0.9 = 0.198X$
Number of aspirants who didn't get the final offer = $0.802X + 15000$
Number of aspirants who didn't join the bank = $0.22X - 700$
Number of aspirants who joined the bank = $700 - 0.022X$

Sum of the number of aspirants who got the final offer in both the exams Q and R = $0.22X + 0.198X = 0.418X$

According to question,
 $0.418X = 8360$
 $\Rightarrow X = 20000$

Required difference = $X + 15000 - 0.78X = 0.22X + 15000$
 $= 0.22 \times 20000 + 15000 = 19400$

Hence, the answer is option C.

69. Ans. E.

Examination Q:

Number of aspirants appeared for prelims = 1500000
Number of aspirants qualified for mains = $1500000 \times 0.1 = 150000$
Number of aspirants who didn't qualify for mains = $1500000 - 150000 = 1350000$
Number of aspirants qualified for GD-PI = X
Number of aspirants who got the final offer = $0.22X$

Number of aspirants who didn't get the final offer = $0.78X$

Number of aspirants who joined the bank = 1000

Number of aspirants who didn't join the bank = $0.22X - 1000$

Examination R:

Number of aspirants appeared for prelims = $1350000 + 150000 \times 0.3333 = 1400000$

Number of aspirants qualified for mains = $1400000 \times 0.2 = 280000$

Number of aspirants who didn't qualify for mains = $1400000 - 280000 = 1120000$

Number of aspirants qualified for GD-PI = $X + 15000$

Number of aspirants who got the final offer = $0.22X \times 0.9 = 0.198X$

Number of aspirants who didn't get the final offer = $0.802X + 15000$

Number of aspirants who didn't join the bank = $0.22X - 700$

Number of aspirants who joined the bank = $700 - 0.022X$

Number of aspirants who didn't qualify for mains of exam Q in 2020 = $1120000 \times 1.25 = 1400000$

Number of aspirants who qualified for GD-PI of Exam R in 2019 = $1400000 \times 0.02 = 28000$

Now, $X + 15000 = 28000$
 $\Rightarrow X = 13000$

Number of aspirants who didn't join the bank after taking Exam Q out of those who got the final offer in 2019 = $0.22X - 1000 = 0.22 \times 13000 - 1000 = 1860$

Hence, the answer is option E.

70. Ans. B.

Examination Q:

Number of aspirants appeared for prelims = 1500000

Number of aspirants qualified for mains = $1500000 \times 0.1 = 150000$

Number of aspirants who didn't qualify for mains = $1500000 - 150000 = 1350000$

Number of aspirants qualified for GD-PI = X

Number of aspirants who got the final offer = $0.22X$

Number of aspirants who didn't get the final offer = $0.78X$

Number of aspirants who joined the bank = 1000

Number of aspirants who didn't join the bank = $0.22X - 1000$

Examination R:

Number of aspirants appeared for prelims = $1350000 + 150000 \times 0.3333 = 1400000$

Number of aspirants qualified for mains = $1400000 \times 0.2 = 280000$

Number of aspirants who didn't qualify for mains = $1400000 - 280000 = 1120000$

Number of aspirants qualified for GD-PI = $X + 15000$

Number of aspirants who got the final offer = $0.22X \times 0.9 = 0.198X$

Number of aspirants who didn't get the final offer = $0.802X + 15000$

Number of aspirants who didn't join the bank = $0.22X - 700$

Number of aspirants who joined the bank = $700 - 0.022X$

Number of aspirants who didn't qualify for mains of exam Q in 2020 = $1120000 \times 1.25 = 1400000$

Number of aspirants who qualified for GD-PI of Exam R in 2019 = $1400000 \times 0.02 = 28000 = X + 15000$

$\Rightarrow X = 13000$

Number of aspirants who didn't join the bank after getting final offer in exam R = $0.22X - 700 = 0.22 \times 13000 - 700 = 2160$

Required percentage = $\frac{2160}{150000} \times 100$

= 1.44%

Hence, the answer is option B.

71. Ans. C.

By approximation, we get:

$1331^{(1/3)} - 6 + 17^2 - 1444^{(1/2)} = ?^2 \times 4$

$\Rightarrow 11 - 6 + 289 - 38 = ?^2 \times 4$

$\Rightarrow 64 = ?^2$

$\Rightarrow ? = 8$

Hence, the answer is option C.

72. Ans. E.

By approximation, we get:

$\frac{\sqrt{784} + \sqrt[3]{2197} - 60 \div 3}{\sqrt{9 \times 3 - 36 \times \frac{2}{3}}} = ?$

$\Rightarrow \frac{28 + 13 - 20}{\sqrt{27 - 24}} = ?$

$\Rightarrow ? = \frac{21}{\sqrt{3}}$

$\Rightarrow ? = 7\sqrt{3}$

Hence, the answer is option E.

73. Ans. A.

By approximation, we get:

$10^{\frac{5}{2}} \div 10^{-\frac{1}{2}} - ?^3 = 30 \times 9$

$\Rightarrow 10^{(\frac{5}{2} + \frac{1}{2})} - 30 \times 9 = ?^3$

$$\Rightarrow ?^3 = 10^3 - 270$$

$$\Rightarrow ?^3 = 730$$

$$\Rightarrow ? \approx 9$$

Hence, the answer is option A.

74. Ans. D.

By approximation, we get:

$$84 \times 4\frac{3}{7} - 84 = (? \sqrt{2})^2$$

$$\Rightarrow 84 \times (4\frac{3}{7} - 1) = ?^2 \times 2$$

$$\Rightarrow 84 \times (\frac{31-7}{7}) = ?^2 \times 2$$

$$\Rightarrow 12 \times 12 \times 2 = ?^2 \times 2$$

$$\Rightarrow ? = 12$$

Hence, the answer is option D.

75. Ans. C.

By approximation, we get:

$$567 + 447 = 2^? - ?$$

$$\Rightarrow 1014 + ? = 2^?$$

$$\Rightarrow ? = 10$$

Hence, the answer is option C.

76. Ans. C.

Let actual speed of the train = $3a$ kmph, then

According to question

$$\frac{480}{3a} - 1.5 = \frac{480}{4a}$$

$$\Rightarrow 160 - 1.5a = 120$$

$$\Rightarrow 1.5a = 160 - 120 = 40$$

Hence, the actual speed of train =

$$3a = 2 \times 1.5a = 2 \times 40 = 80 \text{ km/hr}$$

$$= 80 \times \frac{5}{18} = \frac{200}{9} \text{ m/s.}$$

77. Ans. E.

Let number of students of age 10 years or less = a

And let number of students of age more than 10 years = b

Then according to the question

$$\Rightarrow 70a + 120b = 3210$$

$$\Rightarrow 7a + 12b = 321$$

Now, value of (a, b) satisfying for this equation will be = $(3, 25), (15, 18), (27, 11), (39, 4)$

But

$$3 + 25 = 28$$

$$15 + 18 = 33$$

$$27 + 11 = 38$$

$$39 + 4 = 43$$

Of all these values only $(15, 18)$ satisfies the given condition - (Total number of students was $30 < a < 35$)

Hence, the required ratio = $18 : 15 = 6 : 5$.

78. Ans. C.

It is given that the shopkeeper made a profit of Rs. 70 on selling both the articles. So, we can write the following:

Total cost price of the articles = $3770 - 70 = \text{Rs. } 3700$

Let the cost price of the article which was sold at 10% profit be Rs. $100a$.

So, the cost price of the article which was sold at 10% loss = $(3700 - 100a) = \text{Rs. } 100(37 - a)$

According to the question, we can write the following:

$$(100a + 10\% \text{ of } 100a) + [100(37 - a) - 10\% \text{ of } 100(37 - a)] = 3770$$

$$\Rightarrow 110a + 90(37 - a) = 3770$$

$$\Rightarrow 20a = 3770 - 3330 = 440$$

Hence, the cost price of the article which was sold at 10% profit = $100a = 20a \times 5 = 440 \times 5 = \text{Rs. } 2200$

Hence, option (C) is the correct answer.

79. Ans. D.

Let the rate of interest = $a\%$ per annum

Difference of compound and simple interest after 2 years = $P \times \left(\frac{a}{100}\right)^2$

$$540 = 24000 \times \left(\frac{a}{100}\right)^2$$

$$\Rightarrow \frac{9}{400} = \left(\frac{a}{100}\right)^2$$

$$\Rightarrow \left(\frac{3}{20}\right)^2 = \left(\frac{a}{100}\right)^2$$

Hence, the required rate = $a = 3 \times 5 = 15\%$.

80. Ans. C.

Let the concentration of alcohol in solution A = $a\%$ and in solution B = $b\%$

When they are mixed in the ratio 1 : 4, then

$$\frac{a + 4b}{5} = 32$$

$$\Rightarrow a + 4b = 160 \dots\dots (i)$$

And when mixed in the ratio 4 : 1, then

$$\frac{4a + b}{5} = 68$$

$$\Rightarrow 4a + b = 340 \dots\dots (ii)$$

On solving equations (i) and (ii), we get

$$a = 80 \text{ and } b = 20$$

Hence, the required ratio = $a : b = 80 : 20 = 4 : 1$.

81. Ans. B.

1) B sits fourth to the left of M.

2) L sits adjacent to B.

Here, we have two possible cases i.e. Case 1 and Case 2.

Case 1

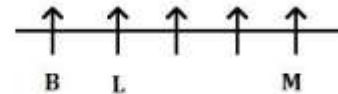

Case 2

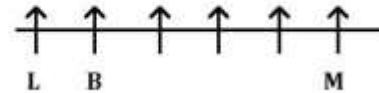

3) Two people sit between B and A who sits at the extreme end.

4) Four people sit between P and L. Here, case 2 gets eliminated.

Case 1

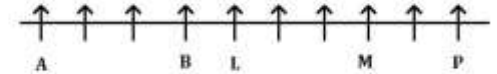

5) Three people sit between P and T.

6) R sits third to the left of P.

Here, we have one more case i.e. Case 3.

Case 1

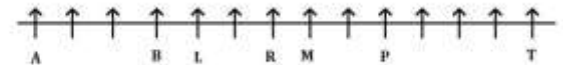

Case 3

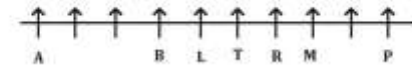

7) N sits adjacent to R.

Here, case 3 gets eliminated.

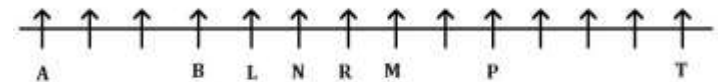

8) Number of people sit to the left of B is half of the number of people sit to the right of T.

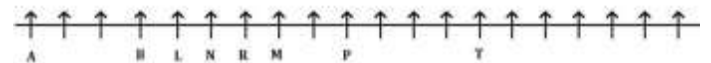

82. Ans. E.

1) B sits fourth to the left of M.

2) L sits adjacent to B.

Here, we have two possible cases i.e. Case 1 and Case 2.

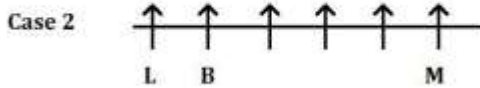
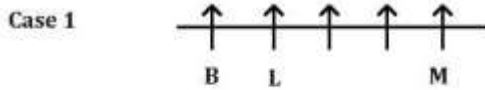

3) Two people sit between B and A who sits at the extreme end.

4) Four people sit between P and L. Here, case 2 gets eliminated.

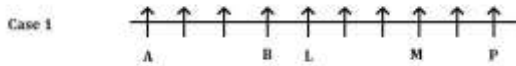

5) Three people sit between P and T.

6) R sits third to the left of P. Here, we have one more case i.e. Case 3.

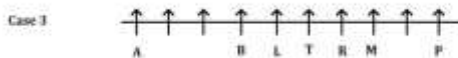
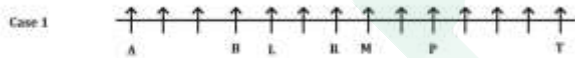

7) N sits adjacent to R. Here, case 3 gets eliminated.

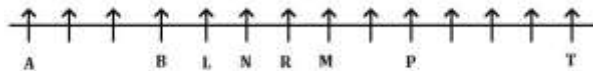

8) Number of people sit to the left of B is half of the number of people sit to the right of T.

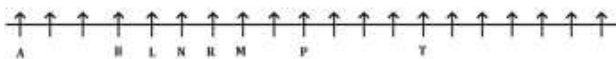

83. Ans. B.

- 1) B sits fourth to the left of M.
- 2) L sits adjacent to B.

Here, we have two possible cases i.e. Case 1 and Case 2.

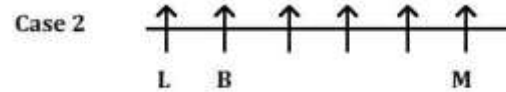
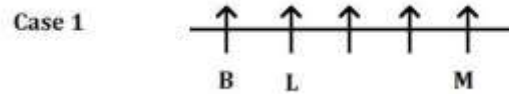

3) Two people sit between B and A who sits at the extreme end.

4) Four people sit between P and L. Here, case 2 gets eliminated.

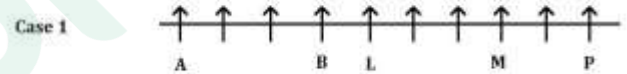

5) Three people sit between P and T.

6) R sits third to the left of P. Here, we have one more case i.e. Case 3.

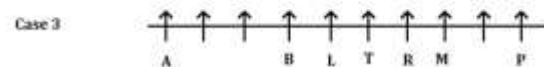
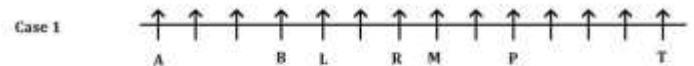

7) N sits adjacent to R. Here, case 3 gets eliminated.

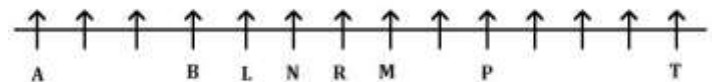

8) Number of people sit to the left of B is half of the number of people sit to the right of T.

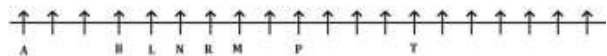

84. Ans. A.

1) B sits fourth to the left of M.

2) L sits adjacent to B.

Here, we have two possible cases i.e. Case 1 and Case 2.

Case 1

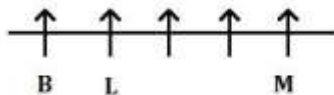

Case 2

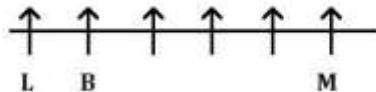

3) Two people sit between B and A who sits at the extreme end.

4) Four people sit between P and L. Here, case 2 gets eliminated.

Case 1

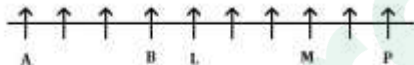

5) Three people sit between P and T.

6) R sits third to the left of P. Here, we have one more case i.e. Case 3.

Case 1

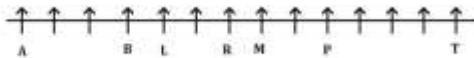

Case 3

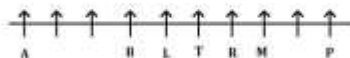

7) N sits adjacent to R.

Here, case 3 gets eliminated.

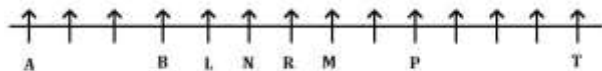

8) Number of people sit to the left of B is half of the number of people sit to the right of T.

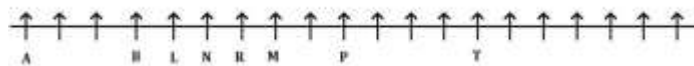

85. Ans. E.

1) B sits fourth to the left of M.

2) L sits adjacent to B.

Here, we have two possible cases i.e. Case 1 and Case 2.

Case 1

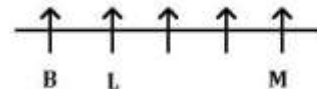

Case 2

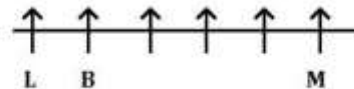

3) Two people sit between B and A who sits at the extreme end.

4) Four people sit between P and L. Here, case 2 gets eliminated.

Case 1

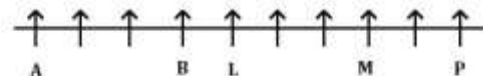

5) Three people sit between P and T.

6) R sits third to the left of P. Here, we have one more case i.e. Case 3.

Case 1

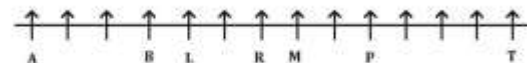

Case 3

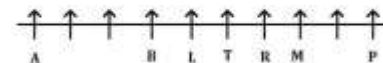

7) N sits adjacent to R.

Here, case 3 gets eliminated.

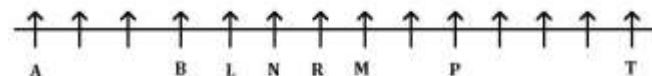

8) Number of people sit to the left of B is half of the number of people sit to the right of T.

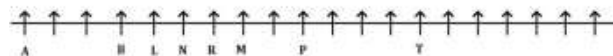

86. Ans. D.

1) Box B kept just below to the box which belongs to Japan.

2) Box B kept at even numbered position.

Here, we have two possible cases i.e. case 1 and Case 2.

	Case 1		Case 2	
	Box	Country	Box	Country
6				
5		Japan		
4	B			
3				Japan
2			B	
1				

3) Two boxes kept between Box B and Box D which belongs to Poland.

4) Box F kept just above Box D.

5) The box which belongs to India kept at odd numbered position.

	Case 1		Case 2	
	Box	Country	Box	Country
6			F	
5		Japan	D	Poland
4	B			
3		India		Japan
2	F		B	
1	D	Poland		India

6) Two boxes kept between the box which belongs to India and Box C.

7) Number of boxes kept below Box C is two more than number of boxes kept above Box A.

Here, case 2 gets eliminated.

	Case 1	
	Box	Country
6	C	
5	E	Japan
4	B	
3	A	India
2	F	
1	D	Poland

8) Box F and C does not belong to China.

9) The box belongs to Norway kept above the box belongs to China.

	Box	Country
6	C	Norway
5	E	Japan
4	B	China
3	A	India
2	F	Germany
1	D	Poland

87. Ans. A.

1) Box B kept just below to the box which belongs to Japan.

2) Box B kept at even numbered position.

Here, we have two possible cases i.e. case 1 and Case 2.

	Case 1		Case 2	
	Box	Country	Box	Country
6				
5		Japan		
4	B			
3				Japan
2			B	
1				

3) Two boxes kept between Box B and Box D which belongs to Poland.

4) Box F kept just above Box D.

5) The box which belongs to India kept at odd numbered position.

	Case 1		Case 2	
	Box	Country	Box	Country
6			F	
5		Japan	D	Poland
4	B			
3		India		Japan
2	F		B	
1	D	Poland		India

6) Two boxes kept between the box which belongs to India and Box C.

7) Number of boxes kept below Box C is two more than number of boxes kept above Box A.

Here, case 2 gets eliminated.

	Case 1	
	Box	Country
6	C	
5	E	Japan
4	B	
3	A	India
2	F	
1	D	Poland

8) Box F and C does not belong to China.

9) The box belongs to Norway kept above the box belongs to China.

	Box	Country
	6	C
5	E	Japan
4	B	China
3	A	India
2	F	Germany
1	D	Poland

88. Ans. B.

1) Box B kept just below to the box which belongs to Japan.

2) Box B kept at even numbered position.

Here, we have two possible cases i.e. case 1 and Case 2.

	Case 1		Case 2	
	Box	Country	Box	Country
6				
5		Japan		
4	B			
3				Japan
2			B	
1				

- 3) Two boxes kept between Box B and Box D which belongs to Poland.
 4) Box F kept just above Box D.
 5) The box which belongs to India kept at odd numbered position.

	Case 1		Case 2	
	Box	Country	Box	Country
6			F	
5		Japan	D	Poland
4	B			
3		India		Japan
2	F		B	
1	D	Poland		India

- 6) Two boxes kept between the box which belongs to India and Box C.
 7) Number of boxes kept below Box C is two more than number of boxes kept above Box A.
 Here, case 2 gets eliminated.

	Case 1	
	Box	Country
6	C	
5	E	Japan
4	B	
3	A	India
2	F	
1	D	Poland

- 8) Box F and C does not belong to China.
 9) The box belongs to Norway kept above the box belongs to China.

	Box	Country
	6	C
5	E	Japan
4	B	China
3	A	India
2	F	Germany
1	D	Poland

89. Ans. D.

- 1) Box B kept just below to the box which belongs to Japan.
 2) Box B kept at even numbered position.
 Here, we have two possible cases i.e. case 1 and Case 2.

	Case 1		Case 2	
	Box	Country	Box	Country
6				
5		Japan		
4	B			
3				Japan
2			B	
1				

- 3) Two boxes kept between Box B and Box D which belongs to Poland.
 4) Box F kept just above Box D.
 5) The box which belongs to India kept at odd numbered position.

	Case 1		Case 2	
	Box	Country	Box	Country
6			F	
5		Japan	D	Poland
4	B			
3		India		Japan
2	F		B	
1	D	Poland		India

- 6) Two boxes kept between the box which belongs to India and Box C.
 7) Number of boxes kept below Box C is two more than number of boxes kept above Box A.
 Here, case 2 gets eliminated.

	Case 1	
	Box	Country
6	C	
5	E	Japan
4	B	
3	A	India
2	F	
1	D	Poland

- 8) Box F and C does not belong to China.
 9) The box belongs to Norway kept above the box belongs to China.

	Box	Country
	6	C
5	E	Japan
4	B	China
3	A	India
2	F	Germany
1	D	Poland

90. Ans. C.

- 1) Box B kept just below to the box which belongs to Japan.
 2) Box B kept at even numbered position.
 Here, we have two possible cases i.e. case 1 and Case 2.

	Case 1		Case 2	
	Box	Country	Box	Country
6				
5		Japan		
4	B			
3				Japan
2			B	
1				

- 3) Two boxes kept between Box B and Box D which belongs to Poland.
 4) Box F kept just above Box D.
 5) The box which belongs to India kept at odd numbered position.

	Case 1		Case 2	
	Box	Country	Box	Country
6			F	
5		Japan	D	Poland
4	B			
3		India		Japan
2	F		B	
1	D	Poland		India

- 6) Two boxes kept between the box which belongs to India and Box C.
 7) Number of boxes kept below Box C is two more than number of boxes kept above Box A.
 Here, case 2 gets eliminated.

	Case 1	
	Box	Country
6	C	
5	E	Japan
4	B	
3	A	India
2	F	
1	D	Poland

- 8) Box F and C does not belong to China.
 9) The box belongs to Norway kept above the box belongs to China.

	Box	Country
6	C	Norway
5	E	Japan
4	B	China
3	A	India
2	F	Germany
1	D	Poland

91. Ans. B.

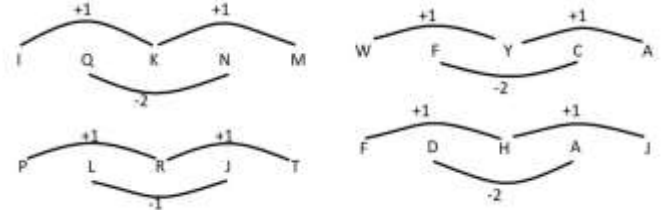

92. Ans. C.

Meaningful word – COPY

First letter – C

93. Ans. C.

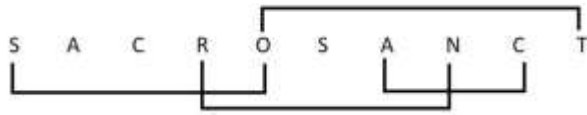

94. Ans. E.

1) Only three persons are there between E and F, who is either the heaviest or the lightest among all.

CASE 1:

$F > ___ > ___ > ___ > E > ___$

CASE 2:

$___ > E > ___ > ___ > ___ > F$

2) A is lighter than C but heavier than B, whose weight is 33.

i.e. $C > A > B$

3) E's weight is 58Kg.

CASE 1(a):

$F > C > A > ___ > E (58) > B (33)$

CASE 1(b):

$F > C > ___ > A > E (58) > B (33)$

CASE 2 (a):

$C > E (58) > A > B > ___ > F$

CASE 2 (b):

$___ > E (58) > C > A > B (33) > F$

CASE 2 (c):

$C > E (58) > ___ > A > B (33) > F$

CASE 2 (d):

$C > E (58) > A > ___ > B (33) > F$

4) Difference between the weight of A and D is 5, which is the difference between the weight of D and B.

i.e. $A > D > B$

Hence, CASE 1(b), CASE 2(a, b and c) eliminated.

5) C, whose weight is the multiple of 13 and 5.

i.e. $C = 65$

CASE 1(a):

$F > C (65) > A > D > E (58) > B (33)$

CASE 2 (d):

$C (65) > E (58) > A > D > B (33) > F$

6) Total weight of C and F is 86.

i.e. $C + F = 86$, $F = 86 - 65 = 21$

Hence, F is lighter among all. CASE 1(a) eliminated.

$A = 43$ $D = 38$

Final Solution

$C (65) > A (43) > D (38) > E (58) > B (33) > F (21)$

Hence, If the weight of G and F is 103kg then the difference between the weights of G and C is 17.

95. Ans. D.

1) Only three persons are there between E and F, who is either the heaviest or the lightest among all.

CASE 1:

$F > ___ > ___ > ___ > E > ___$

CASE 2:

$___ > E > ___ > ___ > ___ > F$

2) A is lighter than C but heavier than B, whose weight is 33.

i.e. $C > A > B$

3) E's weight is 58Kg.

CASE 1(a):

$F > C > A > ___ > E (58) > B (33)$

CASE 1(b):

$F > C > ___ > A > E (58) > B (33)$

CASE 2 (a):

$C > E (58) > A > B > ___ > F$

CASE 2 (b):

$___ > E (58) > C > A > B (33) > F$

CASE 2 (c):

$C > E (58) > ___ > A > B (33) > F$

CASE 2 (d):

$C > E (58) > A > ___ > B (33) > F$

4) Difference between the weight of A and D is 5, which is the difference between the weight of D and B.

i.e. $A > D > B$

Hence, CASE 1(b), CASE 2(a, b and c) eliminated.

5) C, whose weight is the multiple of 13 and 5.

i.e. $C = 65$

CASE 1(a):

$F > C (65) > A > D > E (58) > B (33)$

CASE 2 (d):

$C (65) > E (58) > A > D > B (33) > F$

6) Total weight of C and F is 86.

i.e. $C + F = 86, F = 86 - 65 = 17$

Hence, F is lighter among all. CASE 1(a) eliminated.

$A = 43, D = 38$

Final Solution

$C (65) > A (43) > D (38) > E (58) > B (33) > F (17)$

Hence, C is the heaviest among all.

96. Ans. B.

1) Only three persons are there between E and F, who is either the heaviest or the lightest among all.

CASE 1:

$F > ___ > ___ > ___ > E > ___$

CASE 2:

$___ > E > ___ > ___ > ___ > F$

2) A is lighter than C but heavier than B, whose weight is 33.

i.e. $C > A > B$

3) E's weight is 58Kg.

CASE 1(a):

$F > C > A > ___ > E (58) > B (33)$

CASE 1(b):

$F > C > ___ > A > E (58) > B (33)$

CASE 2 (a):

$C > E (58) > A > B > ___ > F$

CASE 2 (b):

$___ > E (58) > C > A > B (33) > F$

CASE 2 (c):

$C > E (58) > ___ > A > B (33) > F$

CASE 2 (d):

$C > E (58) > A > ___ > B (33) > F$

4) Difference between the weight of A and D is 5, which is the difference between the weight of D and B.

i.e. $A > D > B$

Hence, CASE 1(b), CASE 2(a, b and c) eliminated.

5) C, whose weight is the multiple of 13 and 5.

i.e. $C = 65$

CASE 1(a):

$F > C (65) > A > D > E (58) > B (33)$

CASE 2 (d):

$C (65) > E (58) > A > D > B (33) > F$

6) Total weight of C and F is 86.

i.e. $C + F = 86, F = 86 - 65 = 17$

Hence, F is lighter among all. CASE 1(a) eliminated.

$A = 43, D = 38$

Final Solution

$C (65) > A (43) > D (38) > E (58) > B (33) > F (17)$

Hence, E is the fourth heaviest.

97. Ans. B.

C sits second to the left of A who faces inside the table.

F sits third to the right of C.

C and F face opposite directions.

B faces A.

Case I

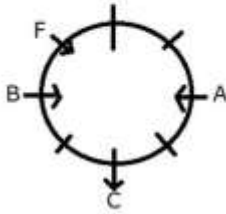

Case II

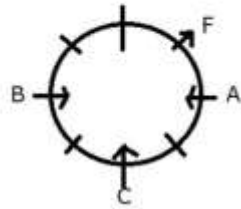

G sits second to the left of F and faces opposite direction of B.

D is not adjacent to C.

Case I

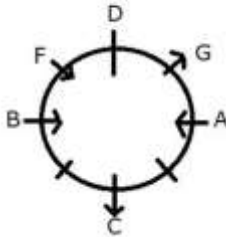

Case II

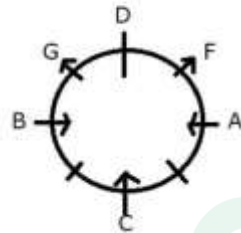

C does not face D.

Hence, case II is eliminated.

E sits second to the left of H, who faces outside the table.

Case I

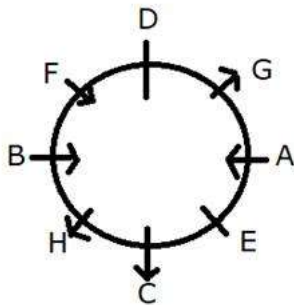

Number of persons facing inside and outside is odd and number of persons facing outside is larger than

the number of persons facing inside the table.

Hence, the only right combination is 3 persons facing inside and 5 persons facing outside.

Case I

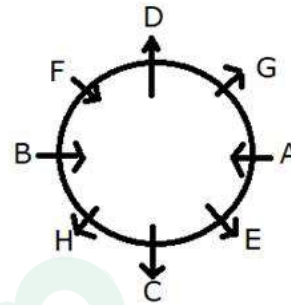

Therefore, this is the final arrangement.

Hence, five persons are facing outside the table.

98. Ans. A.

C sits second to the left of A who faces inside the table.

F sits third to the right of C.

C and F face opposite directions.

B faces A.

Case I

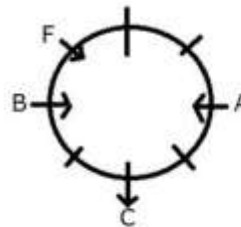

Case II

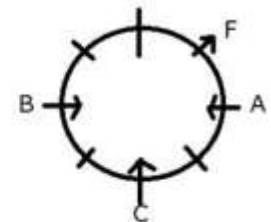

G sits second to the left of F and faces opposite direction of B.

D is not adjacent to C.

Case I

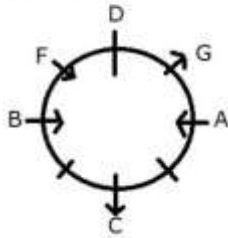

Case II

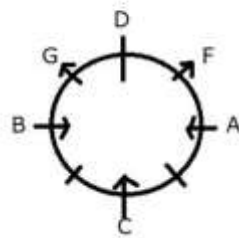

C does not face D.
Hence, case II is eliminated.
E sits second to the left of H, who
faces outside the table.

Case I

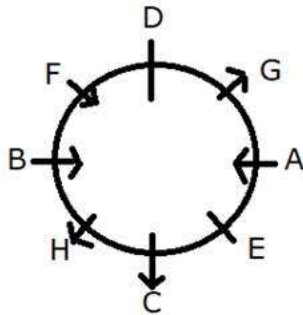

Number of persons facing inside and
outside is odd and number of
persons facing outside is larger than
the number of persons facing inside
the table.

Hence, the only right combination is
3 persons facing inside and 5
persons facing outside.

Case I

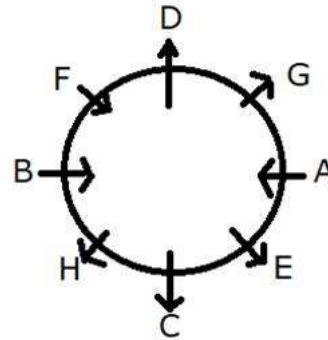

Therefore, this is the final
arrangement.

Hence, F sits opposite of E.

99. Ans. D.

C sits second to the left of A who
faces inside the table.

F sits third to the right of C.

C and F face opposite directions.

B faces A.

Case I

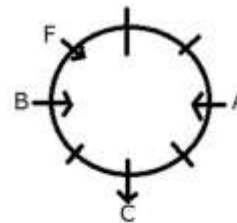

Case II

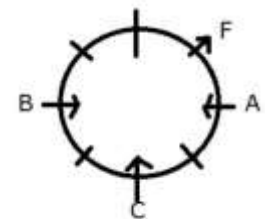

G sits second to the left of F and
faces opposite direction of B.

D is not adjacent to C.

Case I

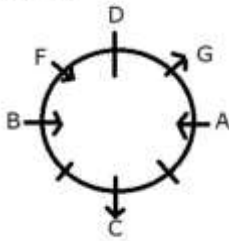

Case II

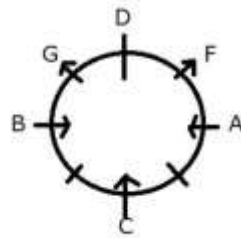

C does not face D.
Hence, case II is eliminated.
E sits second to the left of H, who faces outside the table.

Case I

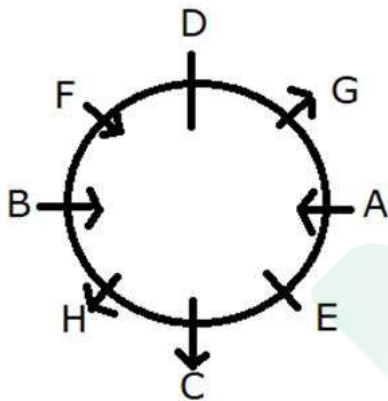

Number of persons facing inside and outside is odd and number of persons facing outside is larger than the number of persons facing inside the table.
Hence, the only right combination is 3 persons facing inside and 5 persons facing outside.

Case I

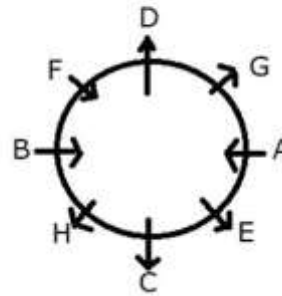

Therefore, this is the final arrangement.

Hence, four persons are seated between A and F when counted clockwise counted from A.

100. Ans. A.

C sits second to the left of A who faces inside the table.

F sits third to the right of C.

C and F face opposite directions.

B faces A.

Case I

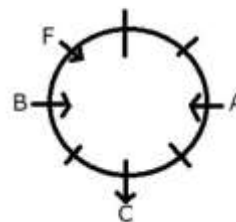

Case II

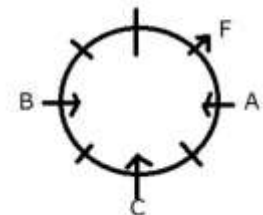

G sits second to the left of F and faces opposite direction of B.

D is not adjacent to C.

Case I

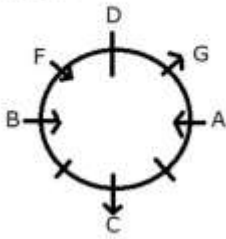

Case II

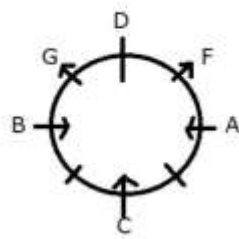

C does not face D.
Hence, case II is eliminated.
E sits second to the left of H, who faces outside the table.

Case I

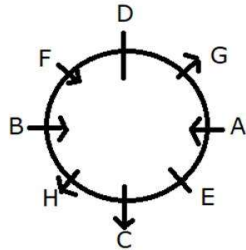

Number of persons facing inside and outside is odd and number of persons facing outside is larger than the number of persons facing inside the table.
Hence, the only right combination is 3 persons facing inside and 5 persons facing outside.

Case I

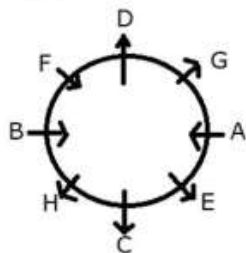

Therefore, this is the final arrangement.

Hence, H sits immediate right of B.
101. Ans. E.

C sits second to the left of A who faces inside the table.

F sits third to the right of C.

C and F face opposite directions.

B faces A.

Case I

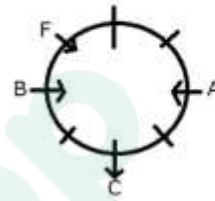

Case II

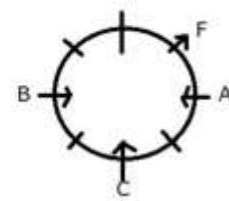

G sits second to the left of F and faces opposite direction of B.
D is not adjacent to C.

Case I

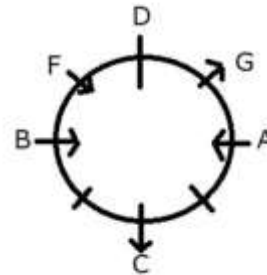

Case II

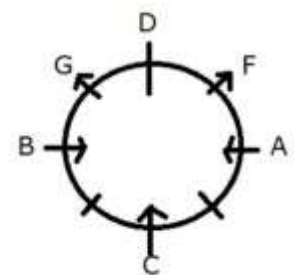

C does not face D.

Hence, case II is eliminated.

E sits second to the left of H, who faces outside the table.

Case I

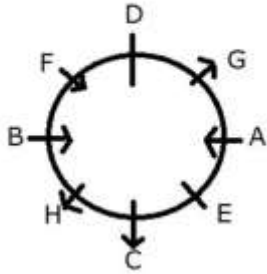

Number of persons facing inside and outside is odd and number of persons facing outside is larger than the number of persons facing inside the table.

Hence, the only right combination is 3 persons facing inside and 5 persons facing outside.

Case I

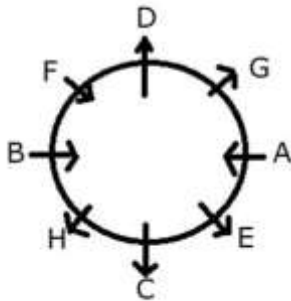

Therefore, this is the final arrangement.

Hence, all except F are facing outside the table.

102. Ans. C.

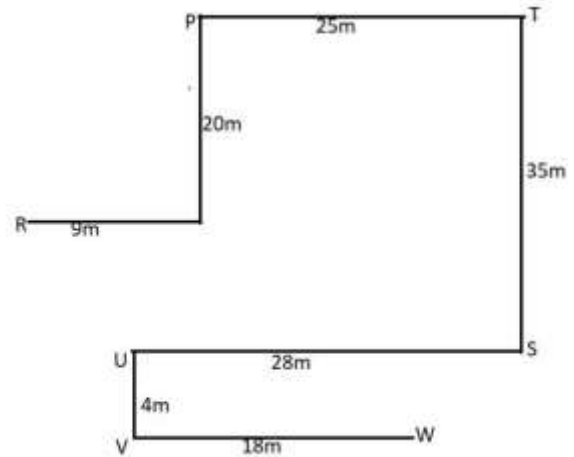

103. Ans. D.

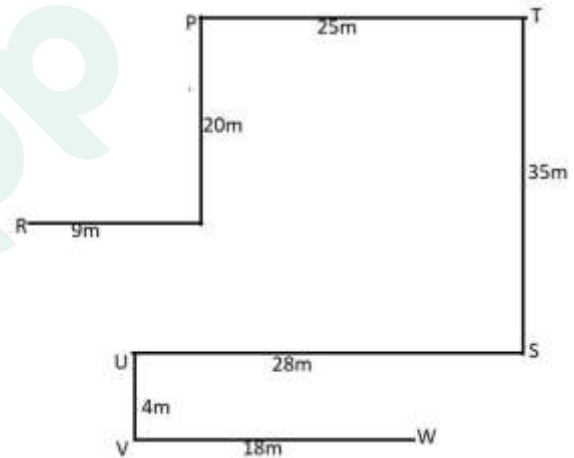

104. Ans. D.

Words	Codes
Group	jb
Ideal	wo
Famous	ts
Country	mn
Movement	xk
Point	ya
Summit	qd
Actual	ut
Affection	df

105. Ans. D.

Words	Codes
Group	jb
Ideal	wo
Famous	ts
Country	mn
Movement	xk
Point	ya
Summit	qd
Actual	ut
Affection	df

106. Ans. A.

Words	Codes
Group	jb
Ideal	wo
Famous	ts
Country	mn
Movement	xk
Point	ya
Summit	qd
Actual	ut
Affection	df

107. Ans. D.

Words	Codes
Group	jb
Ideal	wo
Famous	ts
Country	mn
Movement	xk
Point	ya
Summit	qd
Actual	ut
Affection	df

108. Ans. B.

Words	Codes
Group	jb
Ideal	wo
Famous	ts
Country	mn
Movement	xk
Point	ya
Summit	qd
Actual	ut
Affection	df

109. Ans. E.

Symbol in Diagram	Meaning
○	Female
□	Male
══	Married couple
—	Siblings
	Difference of a Generation

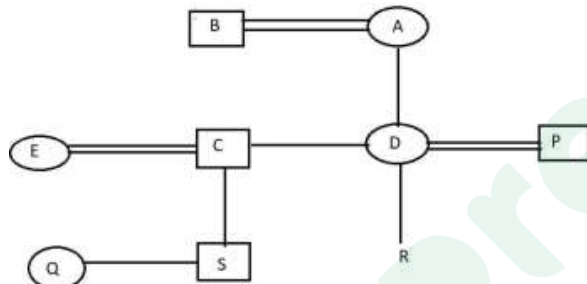

110. Ans. C.

Symbol in Diagram	Meaning
○	Female
□	Male
══	Married couple
—	Siblings
	Difference of a Generation

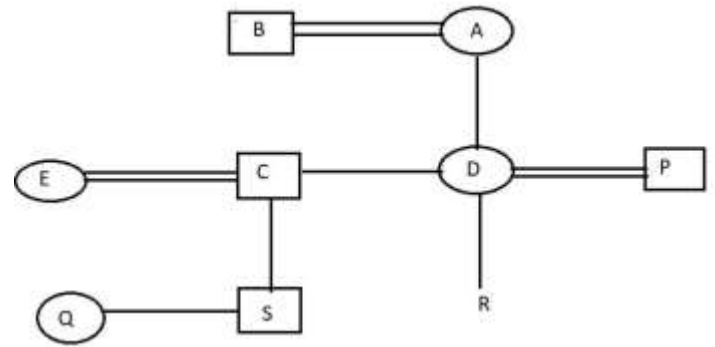

111. Ans. B.

Symbol in Diagram	Meaning
○	Female
□	Male
══	Married couple
—	Siblings
	Difference of a Generation

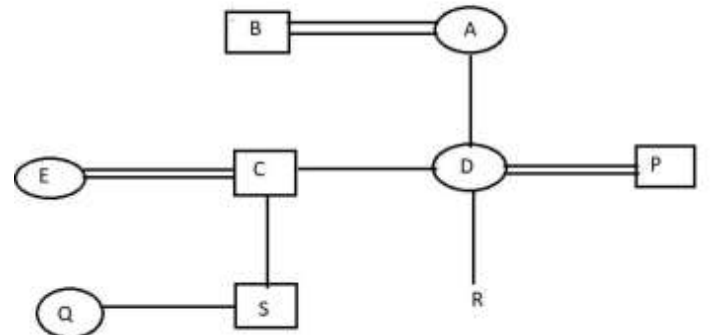

112. Ans. D.

From statement I:

D was born in a month having 30 days before the month September.

B was born in a month having neither 30 nor 31 days.

G was born immediately after H, who was born in a month after July.

People	Months
A	
B	Feb
C	
D	June/April
E	
F	
G	Sept/Oct
H	Oct/Nov

Hence, statement I alone is not sufficient to answer the question.

From statement II:

C was born immediately before D.

A was born in a month that has the same number of days that the month in which H was born has.

E was born in July.

People	Months
A	
B	
C	
D	
E	July
F	
G	
H	

Hence, statement II alone is not sufficient to answer the question.

From statement I and II:

People	Months
A	Jan/Sept
B	Feb
C	April
D	June
E	July
F	
G	Sept/Oct
H	Oct/Nov

Hence, data in statement I and II are not sufficient to answer the question.

113. Ans. D.

Q stands immediate left of L.

An even number of people stands to the right of L.

Case I:

___ Q L ___

Case II:

___ Q L ___

Case III:

Q L ___

From statement I:

Three people stand between K and Q.

R stands at an extreme end of the row.

Case I:

K ___ Q L ___ R

Case II:

R/ ___ Q L ___ K R/

Case III:

Q L ___ K ___ R

Data in statement I is insufficient to answer the question.

From statement II:

M stands immediate left of O, who is not adjacent to K or R.

Data in statement II is insufficient to answer the question.

From statement I and II:

Three people stand between K and Q.

R stands at an extreme end of the row.

M stands immediate left of O, who is not adjacent to K or R.

Case IA:

K _ M O Q L _ R

Case IB:

K M O _ Q L _ R

Case II:

M O Q L _ _ K R

Data in both statement I and II are not sufficient to answer the question.

114. Ans. C.

From statement I:

Two people sit between Q and T, who does not sit at an extreme end of the row.

A, who sits at an extreme end of the row, sits second to the right of E, who sits opposite of P. R sits diagonally opposite of C, who is not adjacent to B.

 A B E D C

 R T P S Q

Hence, data in statement I is sufficient to answer the question.

From statement II:

P sits second to the left of Q, who sits opposite of C.

Four people sit to the left right of C.

E sits in the middle of the row.

B sits opposite of T, who is not adjacent to Q.

T does not sit at the extreme end of the row.

 A/D B E A/D C

 R/S T P R/S Q

Hence, data in statement I is sufficient to answer the question.

115. Ans. B.

From statement I:

In an artificial language,

(i) "pocket red blank" is coded as "kt bl dr";

(ii) "red word small" is coded as "dr os la";

(iii) "pocket blank brown" is coded as "kt wn bl".

Comparing (i) and (iii), we have point blank = bl/kt (but not necessarily in the order)

Comparing (i) and (ii), we have red = dr

Hence, data in statement I is not sufficient to answer the question.

From statement II:

In an artificial language,

"blank fill point" is coded as "bl nt lf";

"point brown fill" is coded as "nt wn lo";

"red point doll" is coded as "dr lo nt";

"doll red brown" is coded as "lo wn dr".

Comparing (i), (ii) and (iii), we have
point = nt

Comparing (i) and (ii), we have fill
= lf

Hence, blank (from (i)) = bl

Comparing (iii) and (iv), we have
red = dr

Hence, red blank = dr bl or bl dr

Thus, data in statement II is alone
sufficient to answer the question.

116. Ans. A.

B sits immediate right of D, who sits
opposite of P.

Case I

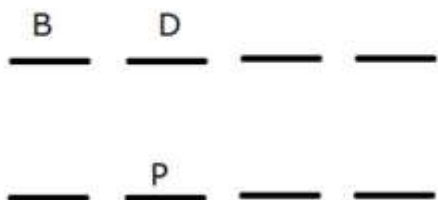

Case II

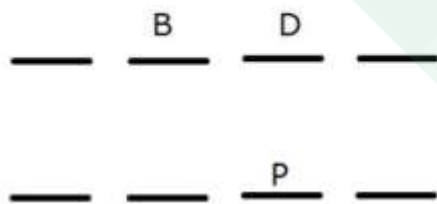

Case III

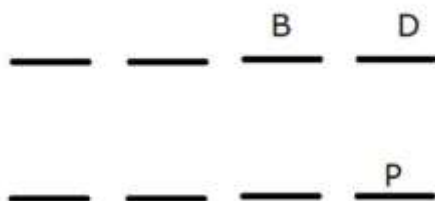

A and C are adjacent to each other.
Hence, case II is eliminated.
Q sits opposite of C.

Case IA

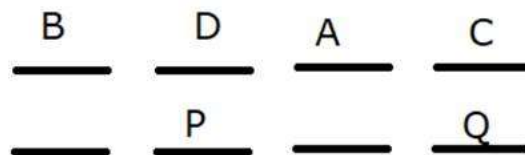

Case IB

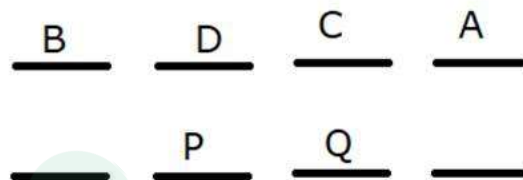

Case IIIA

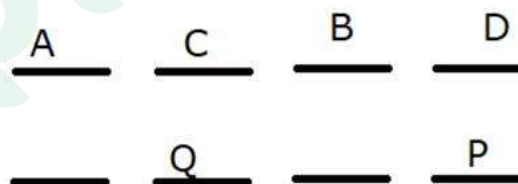

Case IIIB

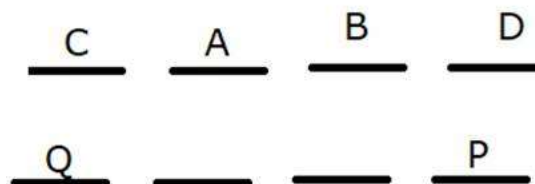

S is adjacent to P.

R is not adjacent to Q.

Hence, case IB, IIIA and IIIB are
eliminated.

Case IA

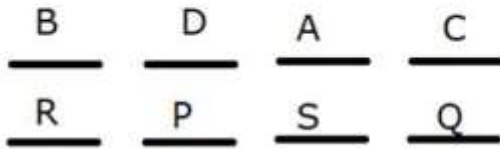

Therefore, this is the final arrangement.

B sits opposite of R.

117. Ans. C.

B sits immediate right of D, who sits opposite of P.

Case I

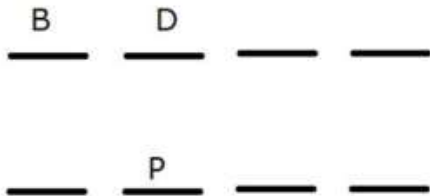

Case II

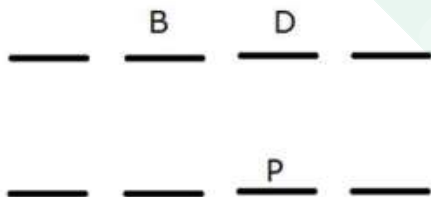

Case III

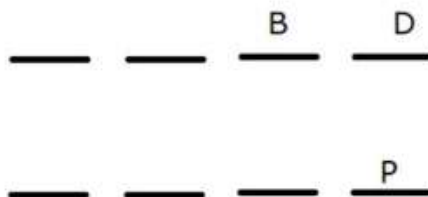

A and C are adjacent to each other. Hence, case II is eliminated.

Q sits opposite of C.

Case IA

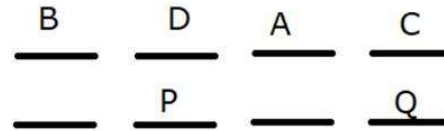

Case IB

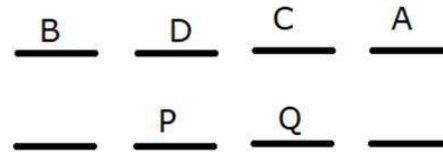

Case IIIA

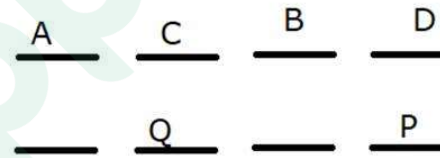

Case IIIB

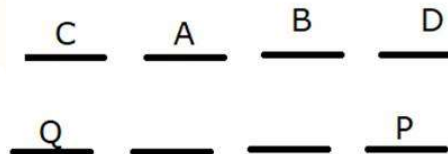

S is adjacent to P.

R is not adjacent to Q.

Hence, case IB, IIIA and IIIB are eliminated.

Case IA

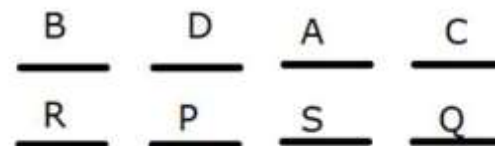

Therefore, this is the final arrangement.

One person sits between B and A, who sits opposite of S.

118. Ans. E.

B sits immediate right of D, who sits opposite of P.

Case I

B	D		
_____	_____	_____	_____

	P		
_____	_____	_____	_____

Case II

	B	D	
_____	_____	_____	_____

		P	
_____	_____	_____	_____

Case III

		B	D
_____	_____	_____	_____

			P
_____	_____	_____	_____

A and C are adjacent to each other.
Hence, case II is eliminated.
Q sits opposite of C.

Case IA

B	D	A	C
_____	_____	_____	_____
	P		Q
_____	_____	_____	_____

Case IB

B	D	C	A
_____	_____	_____	_____
	P	Q	
_____	_____	_____	_____

Case IIIA

A	C	B	D
_____	_____	_____	_____
	Q		P
_____	_____	_____	_____

Case IIIB

C	A	B	D
_____	_____	_____	_____
Q			P
_____	_____	_____	_____

S is adjacent to P.

R is not adjacent to Q.

Hence, case IB, IIIA and IIIB are eliminated.

Case IA

B	D	A	C
_____	_____	_____	_____
R	P	S	Q
_____	_____	_____	_____

Therefore, this is the final arrangement.

All except A sits at extreme ends of the rows.

119. Ans. A.

B sits immediate right of D, who sits opposite of P.

Case I

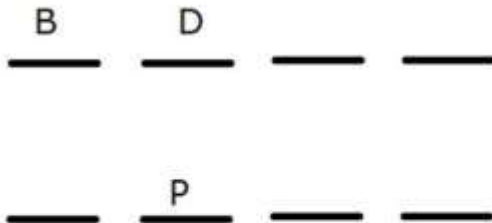

Case II

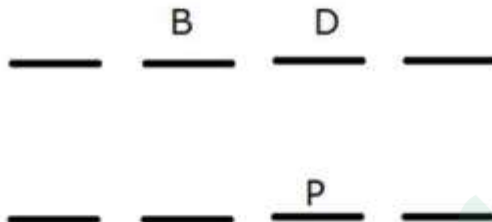

Case III

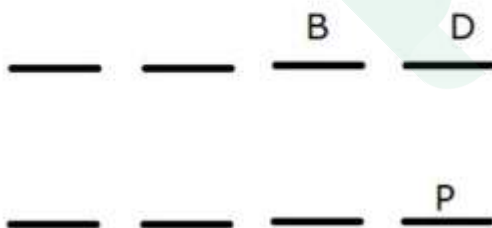

A and C are adjacent to each other.
Hence, case II is eliminated.
Q sits opposite of C.

Case IA

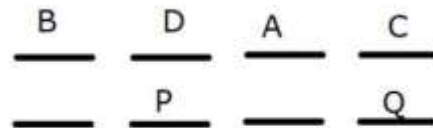

Case IB

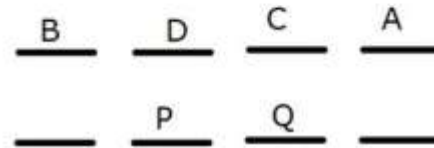

Case IIIA

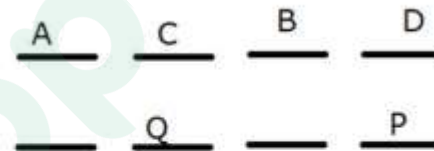

Case IIIB

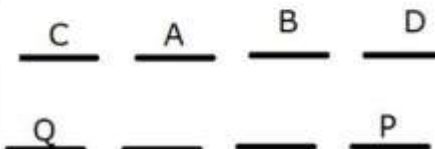

S is adjacent to P.

R is not adjacent to Q.

Hence, case IB, IIIA and IIIB are eliminated.

Case IA

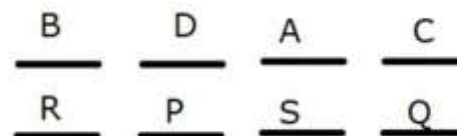

Therefore, this is the final arrangement.

Q sits 3rd to the right of the one who sits at the left end of the row-1.

120. Ans. D.

B sits immediate right of D, who sits opposite of P.

Case I

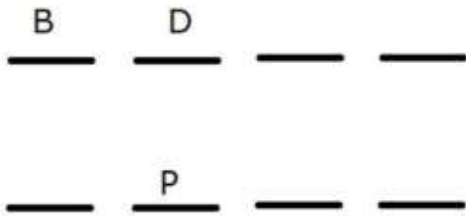

Case II

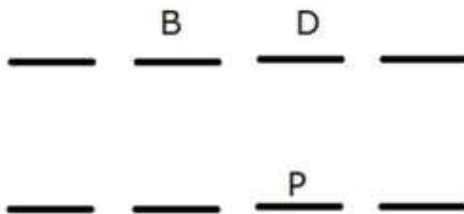

Case III

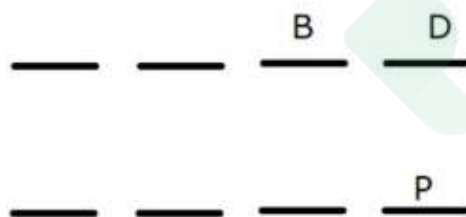

A and C are adjacent to each other.
Hence, case II is eliminated.
Q sits opposite of C.

Case IA

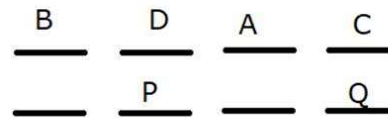

Case IB

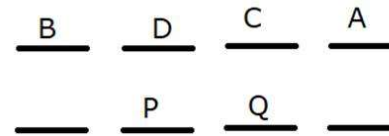

Case IIIA

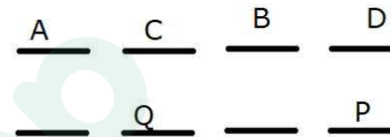

Case IIIB

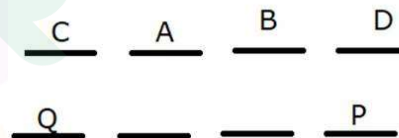

S is adjacent to P.

R is not adjacent to Q.

Hence, case IB, IIIA and IIIB are eliminated.

Case IA

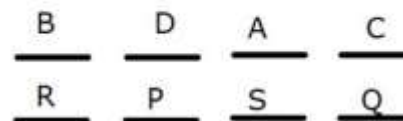

Therefore, this is the final arrangement.

Both A and B are two immediate neighbours of the person who sits opposite of the one who is immediate left of S, i.e. D.

121. Ans. D.

- Economic development , Caring Society and Aspirational India are the themes of Budget 2020-2021.
- In this Budget our finance focuses on the economic development of the country with people care for one another.

122. Ans. D.

In India, the Civil Service Day is celebrated on **21 April every year**. The day is observed by all Civil Services. The main objective of this day to rededicate and recommit themselves to the cause of the people.

123. Ans. B.

Certificate of deposit market deals with the certificate of deposits issued by commercial banks.

- A certificate of deposit is a document of title to a time deposit.
 - The minimum amount of investment should not be less than Rs. 1 lakh and in the multiples of 1 lakh thereafter.
 - The maturity period of CDs issued by banks should not be less than seven days and not more than one year.
 - They are freely transferable by endorsement and delivery.
- Certificate of deposits provides greater flexibility to an investor in the deployment of their short-term funds.

Note:

- Certificate of Deposit (CD) is a negotiable money market instrument and issued in dematerialised form or as a Usance

Promissory Note against funds deposited at a bank or other eligible financial institution for a specified time period.

- CDs can be issued by (i) scheduled commercial banks {excluding Regional Rural Banks and Local Area Banks}; and (ii) select All-India Financial Institutions (FIs) that have been permitted by RBI to raise short-term resources within the umbrella limit fixed by RBI.

124. Ans. A.

• The Reserve Bank of India has approved the appointment of Sashidhar Jagdishan as the next managing director of HDFC Bank, succeeding veteran Aditya Puri. He will take charge in October when Puri retires.

• Aditya Puri was the CEO of HDFC Bank since September 1994. He is the longest-serving head of any private bank in India.

• Sashidhar Jagdishan is a chartered accountant. He holds a Master's degree in Economics of money, banking and finance. He joined the Bank in 1996 and heads finance, human resources, and other departments.

125. Ans. D.

• Tamal Bandyopadhyay has authored a book titled "Pandemonium: The Great Indian Banking Tragedy" and will be released on November 09, 2020.

• This book, published by Roli Books, provides an understanding of the challenges and economic potential of India.

• The book "Pandemonium" accounts how many promoters had swapped equity with debt while the managements of the banks were finding a way to protect their balance sheets until the intervention of the Reserve Bank of India (RBI) against their bad loans.

126. Ans. A.

* The Veteran Violinist and Padama Shri & Padma Bhushan Awardee Tripunithura Narayanaiyer Krishnan (T N Krishnan) passed away at the age of 92 at Chennai, Tamil Nadu. He was born in 1928 in Kerala.

* T N Krishnan was a child prodigy who made his first solo violin concert in Triruvantahpuran in 1939.

* ii. He was mentored by Alleppy K. Parthasarathy and had accompanied numerous musicians like Ariyakudi Ramanuja Iyengar, Musiri Subramania Iyer, Alathur Brothers, Madurai Mani Iyer, Chembai Vaidyanatha Bhagavatar among others.

127. Ans. C.

* India's largest lender State Bank of India has entered into a partnership with FMCG major Hindustan Unilever to offer corporate solutions to its trade partners.

* The partnership aims to make availing of credit easy for channel partners, provides UPI based payment solutions and PoS terminals to retailers & distributors

* The objective of the partnership is to augment the width of credit and

will be beginning a pilot in Mumbai and Bengaluru.

128. Ans. B.

* Abu Dhabi's Sovereign Wealth Fund (SWF) - MIC Redwood 1 RSC Limited - has become the first foreign SWF that has been notified and granted 100% income-tax exemption for the long-term investments to be made in the specified priority sectors in India.

* This decision is on the lines of July 6, 2020 government notification regarding to broaden the scope of this exemption and to expedite foreign investment in the country's priority areas during the Covid-19 pandemic.

129. Ans. B.

• Vigilance Awareness Week, 2020 will be observed from 27th October till 2nd November.

• Vigilance Awareness Week 2020 Theme: Satark Bharat, Samriddh Bharat (Vigilant India, Prosperous India).

• It is commemorated to affirm our commitment towards promotion of integrity and probity in public life through citizen participation.

130. Ans. D.

Exercise Malabar is a trilateral naval exercise involving the United States, Japan and India as permanent partners. The past non-permanent members are Australia and Singapore.

131. Ans. B.

Kanha Tiger Reserve also called Kanha National Park is one of the **tiger reserves** of India and the

largest national park of Madhya Pradesh state in India.

Note:-Kanha national park cum Tiger reserve extends over an area of over **1,940-sq-kms**.

132. Ans. B.

- In Madhya Pradesh, the Panna Tiger Reserve has been included in the 'World Network of Biosphere Reserves' list of the UNESCO.

- This is the 12th biosphere reserve from India to be included in the 'World Network of Biosphere Reserves', and third from Madhya Pradesh, after Pachmarhi and Amarkantak. Currently, Panna Tiger Reserve is home to 54 tigers.

- The UNESCO World Network of Biosphere Reserves (WNBR) covers internationally designated protected areas (known as biosphere reserves) that demonstrate a balanced relationship between people and nature (like encourage sustainable development).

133. Ans. C.

- State Bank of India (SBI), the country's largest lender by assets, on Wednesday reported a net profit of Rs 4,574.16 crore in the July-September period.

- That marked an increase of 52 per cent compared to its profit of ₹ 3,011.73 crore in the corresponding period a year ago.

- Lower provisioning for non-performing assets - or bad loans - boosted Mumbai-based SBI's profitability in the second quarter of current financial year.

- The bank's net interest income - or the difference between interest earned and interest paid - grew 14.55 per cent to ₹ 28,181.50 crore in the quarter ended September 30, from ₹ 24,600.32 crore in the year-ago period.

134. Ans. B.

- Portugal MP, Duarte Pacheco has won the elections for the post the President of the Inter-Parliamentary Union (IPU).

- The term of the Duarte Pacheco will be from 2020-2023.

- He will be the 30th President of the IPU and will succeed Mexican MP Gabriela Cuevas Barron who completed the tenure in October 2020.

135. Ans. B.

- The 40th Meeting of the SAARCFINANCE Governors' Group was held virtually, under the Chairmanship of Shri Shaktikanta Das, Governor, RBI.

- The meeting was attended by the Governors from SAARC central banks. During the meeting, Mr Das also inaugurated the SAARCFINANCE Sync, a closed user group secure communication network.

- The central bank of Bhutan is not correctly matched as its name is Royal monetary authority of Bhutan.

136. Ans. A.

- The Reserve Bank of India has prescribed that housing finance companies should have atleast 60%

of total assets towards housing finance by 31 March 2024.

- Following the review of the regulatory framework for HFCs, the central bank said that these HFCs should have minimum ₹20 crore as the minimum net owned funds (NOFO requirement for a company to commence housing finance as its principal business or carry on the business of housing finance as its principal business.

- The revision in rules are based on the recommendations made in July this year following RBI's taking over as the regulator of mortgage lenders from National Housing Bank (NHB) in August 2019.

- Following the review of the rules, home financiers will now be regulated as a category of non-banking financial companies.

137. Ans. A.

- Congress has 535 voting members: 100 senators and 435 representatives, the latter defined by the Reapportionment Act of 1929.

- In addition, the House of Representatives has six non-voting members, bringing the total membership of the US Congress to 541 or fewer in the case of vacancies.

138. Ans. D.

- Finance minister Nirmala Sitharaman on Saturday launched a common online platform named eBkay to auction assets attached by various state-run banks, seeking to bring in transparency in the sale

of 35,000 properties currently available and many more in future.

- After a meeting with chiefs of state-run banks on Saturday, ahead of the Budget, the minister also announced that the revenue department will notify RuPay and UPI as the prescribed mode of payment for undertaking digital transactions without any MDR charges from January 1, 2020.

- Accordingly, all companies with a turnover of Rs 50 crore and above will be required to offer payment facility through RuPay debit card and UPI QR code to their customers, in sync with a Budget proposal.

139. Ans. B.

- The Scottish actor was best known for his portrayal of James Bond, being the first to bring the role to the big screen and appearing in seven of the spy thrillers.

- Sir Sean died peacefully in his sleep in the Bahamas, having been "unwell for some time".

- His acting career spanned seven decades and he won an Oscar in 1988 for his role in The Untouchables.

- Sir Sean's other films included The Hunt for Red October, Highlander, Indiana Jones and the Last Crusade and The Rock.

140. Ans. A.

- Kia Motors Corporation, commonly known as Kia Motors is a South Korean company.

- Kia Motors Corporation was founded in May 1944 and is Korea's

oldest manufacturer of motor vehicles.

- From humble origins making bicycles and motorcycles, Kia has grown – as part of the dynamic, global Hyundai-Kia Automotive Group – to become the world's fifth largest vehicle manufacturer.

141. Ans. D.

- The issue price for the sovereign gold bond has been fixed at Rs 5,051 per gram of gold.

- The Sovereign Gold Bond Scheme 2020-21-Series VII will be opened for subscription from October 12 to October 16.

- The bonds are denominated in multiples of grams of gold with a basic unit of 1 gram and the tenure of the SGB will be eight years with exit option after fifth year to be exercised on the interest payment dates.

- The bonds are restricted for sale to resident individuals, Hindu Undivided Families (HUFs), trusts, universities and charitable institutions.

- The minimum permissible investment will be 1 gram of gold and the maximum limit of subscription shall be 4 kg for individual, 4 kg for HUF and 20 kg for trusts and similar entities per fiscal (April-March).

142. Ans. B.

- Machu Picchu, the ancient city high in the Andes mountains, has reopened after nearly eight months of closure due to the coronavirus pandemic.

- Peruvian authorities organised an Incan ritual to thank the gods on Sunday as the major tourist attraction once again allowed visitors.

- But numbers will be restricted to just 675 tourists a day for safety reasons, around 30% of previous capacity.

- The citadel was designated a Unesco World Heritage site in 1983.

- Rediscovered in 1911 by a US explorer, the site is the most recognisable ruin from the Inca Empire, which dominated the Andes from the 1430s until the 1530s.

- Archaeologists believe Machu Picchu, meaning old mountain in Quechua, was built as an estate in the 15th century for the Incan emperor Pachacuti.

- It was abandoned a century later when Spanish invaders conquered and colonised the region.

143. Ans. A.

- The RBI mandated a move towards interoperable QR codes. Bharat QR and UPI QR—the two interoperable codes available—will continue, any proprietary codes will need to be phased out by March 2022, and any new QR codes introduced will need to be accepted across payment options.

- The RBI's decisions followed the recommendations of a committee set up to assess the potential of QR-code payments.

- The committee, in its report in July, cited China's successful experience with QR codes.

- In India, QR codes gained popularity in the months after demonetisation, when Paytm rolled out its code-based payments across the country.

- Except Paytm's QR codes were proprietary and could be used only via the Paytm app. Since then, PhonePe, Mobikwik, Razorpay, Freecharge and many others have pushed QR code-based payments to capture transactions made by small and informal merchants, like kir

144. Ans. A.

- The world's longest serving warship, INS Viraat, which has been the Indian Navy's prized asset for decades, will be dismantled at Alang, three years after it was decommissioned by the Indian Navy.

- This Centaur-class aircraft carrier of Indian Navy that remained in service for three decades and holds the Guinness record for the world's longest-serving warship will be dismantled at the world's largest ship breaking yard Alang in Gujarat.

145. Ans. B.

- Distributed ledger technology (DLT) is a digital system for recording the transaction of assets in which the transactions and their details are recorded in multiple places at the same time. Unlike traditional databases, distributed ledgers have no central data store or administration functionality.

- In a distributed ledger, each node processes and verifies every item, thereby generating a record of each

item and creating a consensus on each item's veracity.

- A distributed ledger can be used to record static data, such as a registry, and dynamic data, i.e., transactions.

- This computer architecture represents a significant revolution in record-keeping by changing how information is gathered and communicated.

146. Ans. A.

- As per the RBI, SBICAP, the capital markets wing of State Bank of India (SBI), will set up a special purpose vehicle (SPV) to purchase the short-term papers, maturing within three months and rated as investment grade, from non-banking financial companies (NBFCs).

147. Ans. A.

- Lewis Hamilton is a formula one driver from United Kingdom

- Lewis Hamilton started dreaming about becoming a Formula One driver at the age of six, when his father Anthony bought him his first go-kart for Christmas. His passion for racing only grew stronger after that, and his dad supported him every step of the way.

- He used to work as IT manager at the time, but decided to bet on his son after seeing how determined and passionate he was. After taking redundancy from his job, Anthony invested all his hard-earned money into his son's future, and often worked three jobs to make ends meet.

148. Ans. B.

- The solicitor general of India is appointed to assist the attorney general along with four additional solicitors general by the Appointments Committee of the Cabinet.
- The proposal for appointment of Solicitor General, Additional Solicitor General is generally moved at the, level of Joint secretary/Law Secretary in the Department of Legal Affairs and after obtaining the approval of the Minister of Law & Justice, the proposal is sent to the Appointments Committee of the Cabinet for its approval.
- He is appointed by the President of India.

149. Ans. A.

- Manipal Hospitals, the multi-specialty healthcare providers, today announced its intent to acquire 100% stake in Columbia Asia Hospitals Private Limited for over Rs 2000 crore, sources told ET.
- The integrated entity will ensure improved access and address the growing demand for high quality tertiary and quaternary healthcare in the country.

150. Ans. B.

Interceptor Boat 'ICGS C-454', that has been built by Larsen and Toubro, was launched into the service of the Coast Guard. The newly-built boat of the Indian Coast Guard (ICG) was launched in Surat, as per the recent notification from the Defence Ministry. It has a length of 27 meters and a maximum speed

of 45 nautical miles or 83 kilometers per hour.

151. Ans. E.

* Indian Coast Guard's (ICG) ship C-452, designed and built by Larsen & Toubro was commissioned on 3 November 2020.

* The ICGS C-452 ship was indigenously built in India under the Make in India initiative.

* Indian Coast Guard is an armed force and maritime law enforcement agency established in 1978 under the Coast Guard Act 1978.

* CG operates under Ministry of Defence.

* Indian Coast Guard works in close operation with the State Police Forces (SPF), Department of Revenue, Department of Fisheries and Indian Navy.

* The 4 main regional headquarters of Indian Coast Guard are located in Port Blair (South Andaman Island), Mumbai, Kolkata, Chennai and Gandhinagar (Gujarat).

152. Ans. A.

*** IDFC First Bank is an Indian banking company with headquarters in Mumbai that forms part of IDFC, an integrated infrastructure finance company.**

*** The bank started operations on 1 October 2015. IDFC FIRST received a universal banking licence from the Reserve Bank of India in July 2015.**

153. Ans. D.

The authorised capital of a company (sometimes referred to as the authorised share capital, registered capital or nominal capital, particularly in the United States) is the maximum amount of share capital that the company is authorised by its constitutional documents to issue (allocate) to shareholders.

154. Ans. B.

*** CSIR Institute of Genomics and Integrative Biology is a scientific research institute devoted primarily to biological research.**

*** It is a part of Council of Scientific and Industrial Research, India.**

*** The main IGIB campus is located at Mall Road, New Delhi near Delhi University North Campus.**

155. Ans. B.

*** As per the announcement made by the Reserve Bank of India (RBI) the India Post Payment Bank (IPPB) has been included in the Second Schedule to the Reserve Bank of India Act, 1934 vide Notification DBR.**

156. Ans. A.

* Reserve Bank of India (RBI) has issued a draft framework for grant of recognition to an industry association as a Self-Regulatory Organisation (SRO) for Payment System Operators (PSOs).

*** The SRO shall cover operators in all segments of payment**

systems and will be expected to observe best practices on security, customer protection and competitiveness.

*** The SRO shall serve as a two-way communication channel between the PSOs and Reserve Bank and work towards establishing minimum benchmarks and standards in the payments space, apart from helping disciplined behaviour by members.**

157. Ans. A.

*** The Securities and Exchange Board of India (Sebi) has enhanced the penalty against three rating agencies- ICRA, CARE and India Ratings and Research to Rs 1 crore each for their lapses in giving credit rating to non-convertible debentures of IL&FS.**

*** It has shaken up the investors' faith in the reliability of credit ratings in the context of the corporate debt market. Had the Noticee downgraded the ratings at the appropriate time and thereby forewarned the investors, the impact of the default on investors who invested in AAA rated instruments, could not have been this severe," Sebi whole time member G Mahalingam said in his order. Sebi passed three separate orders on Tuesday in the matter.**

158. Ans. B.

*** The Cabinet Committee on Economic Affairs chaired by Prime Minister Shri Narendra Modi has approved the investment of Rs. 1810.56 crore for 210 MW Luhri Stage-I Hydro Electric Project located on river Satluj which is situated in Shimla & Kullu districts of Himachal Pradesh.**

159. Ans. B.

* The Goods and Services Tax (GST) has come into force w.e.f. 1st July, 2017. GST is a tax on supply of Goods or Services or both except on supply of alcoholic liquor for human consumption.

* Revised Estimate of CGST and IGST for FY 2019-20 are..`5,14,000 Crore and 'nil' respectively as against their

* BE of Rs 5,26,000 crore and Rs. 28,000 Crore respectively.

* B.E. for FY 2020-21 of CGST and IGST are Rs. 5,80,000 Crore and 'nil' respectively.

* IGST revenue is subject to apportionment and fund settlement between Centre and States, as a result of crossutilization of credits.

* RE 2019-20 and BE 2020-21 with regard to GST compensation cess are Rs 98,327 crore and Rs 1,10,500 crore respectively.

160. Ans. B.

• In India, the National Pollution Control Day is observed every year on December 2 to commemorate the life of people lost in the unfortunate incident of Bhopal Gas

Tragedy that occurred in the year 1984 on the night of 2-3 December.

• The year 2020 marks the 36th anniversary of the Bhopal Gas Tragedy.

• Through this day, awareness is created about the rising pollution of air, water, and soil, as well as shifts the attention of people with regards to the pollution control acts.

161. Ans. B.

Disk formatting is the process of preparing a **data storage** device such as a **hard disk drive** for initial use.

It is the process of **dividing** the disk into tracks and sectors.

162. Ans. C.

The shortcut key - F7 helps the user to check spelling and grammar of the selected text or document.

163. Ans. D.

• Ctrl+C is used to copy selected item.

• Ctrl+B is used to change selected text to be bold.

• Ctrl+N is used to create a new or blank document in some software, or open a new tab in most Internet browsers.

• Ctrl+A is used to select all text.

164. Ans. D.

• The protocol used for sending an email is **SMTP - Simple Mail Transfer Protocol.**

• HTTP - Hyper Text Transfer Protocol is used for data communication.

• FTP - File Transfer Protocol is used for the transfer of computer files

between a client and a server on a computer network.

- POP-3: Post Office Protocol, the most recent version, is used to retrieve e-mail from a server in an Internet Protocol network.

165. Ans. B.

Hypertext transfer control protocol is an application for an information system based on distributed, collaborative and hypermedia. It is used in web server applications.

Wireless application protocol is a standard protocol for accessing any information from a wireless mobile network.

File transfer protocol is a network protocol to transfer computer files in any computer network between any client and server.

Transmission control protocol is a basic communication language or protocol of the internet. It is having two version of internet protocol four and six.

166. Ans. A.

The **Hypertext Transfer Protocol** (HTTP) is an **application protocol** for distributed, collaborative, hypermedia information systems. HTTP is the foundation of **data communication** for the World Wide Web.

167. Ans. A.

- For converting decimal to binary number the decimal number is to be divide-by-2 to give a result and a remainder of either a "1" or a "0" until the remainder equals zero.

- On converting decimal number 101, we get 1100101 binary number.

168. Ans. D.

The **control unit** (CU) is a component of a computer's **central processing unit** (CPU) that directs operation of the processor. It tells the computer's **memory, arithmetic/logic unit, input and output** devices how to respond to a program's instructions.

169. Ans. C.

Electrically **erasable programmable read-only memory** (EEPROM) is a special type of **PROM** that can be erased by exposing it to an electrical charge. Like other types of PROM, **EEPROM retains its contents** even when the power is turned off.

170. Ans. B.

Half-duplex data transmission means that data can be transmitted in **both directions** on a signal carrier, **but not at the same time.**

171. Ans. D.

The control unit (CU) is a component of a computer's central processing unit that directs operation of the processor. It tells the computer's memory, arithmetic/logic unit and input and output devices how to respond to a program's instructions.

172. Ans. A.

A set of step-by-step procedures for accomplishing a task is known as an **algorithm.**

An **algorithm** is a procedure or **formula for solving a problem.**

Note:- The word derives from the name of the **mathematician**, Mohammed ibn-Musa al-Khwarizmi.
173. Ans. B.

BIOS (basic input/output system) is the program a personal computer's microprocessor uses to get the computer system started after you turn it on. It also manages data flow between the computer's operating system and attached devices such as the hard disk, video adapter, keyboard, mouse and printer.
174. Ans. C.

Data **processing** is, broadly, the collection and manipulation of items of data to produce meaningful information.
175. Ans. C.

An **Operating System** (OS) is the system software that manages computer hardware and software resources and provides common services for computer programs. The **operating system** is a component of the system software in a computer system. Application programs usually require an operating system to function.
176. Ans. C.

Index sequential files are ordered sequentially on some search key and a primary index is associated with it.
177. Ans. B.

Rich text supports text formatting, such as bold, italics, and underlining, as well as different fonts, font sizes, and colored text.

Note: Rich text documents can also include page formatting options,

such as custom page margins, line spacing, and tab widths.

178. Ans. B.

A **motherboard** is one of the most essential parts of a computer system. It holds together many of the crucial components of a computer, including the central processing unit (CPU), memory and connectors for input and output devices.

Note: The base of a motherboard consists of a very firm sheet of non-conductive material, typically some sort of rigid plastic.

179. Ans. C.

Software Processes include those activities, methods, practices and transformations that are used to create and maintain software products.

180. Ans. B.

A page has 4 margins – Top, bottom, right and left. These margins can be adjusted according to the user's requirements.

181. Ans. E.

• **Optical character recognition (OCR)** is the mechanical or electronic conversion of images of typed, handwritten or printed text into machine-encoded text.

• It is widely used as a **form of data entry** from printed paper data records, whether passport documents, invoices, bank statements, computerized receipts, business cards, mail, printouts of static-data or any suitable documentation.

182. Ans. B.

A **supercomputer** is a computer with **great speed** and **memory**. This kind of computer can do jobs **faster** than any other computer of its generation. They are usually **thousands of times faster** than ordinary personal computers made at that time.

183. Ans. C.

A **password** is an unspaced sequence of characters used to **determine** that a computer user requesting access to a computer system is really that **particular user**.

Note:- In order to **verify** that someone entering that **user ID** really is that person, a **second** identification, the **password** known only to **that person** and to the system itself, is entered by the **user**.

184. Ans. A.

The main purpose software **QA testing** is to find **error** and bugs in the code and eliminate them. In doing so, this assures the solution designed will not fail and work effectively and carry out the functions needed by the client to fulfill the need for the solution.

185. Ans. A.

Cookies are small files which are stored on a **user's computer**. They are designed to hold a **modest amount of data** specific to a **particular client** and website, and can be accessed either by the **web server** or the client computer.

186. Ans. B.

The main purpose of a **primary key** is to implement a relationship between two tables in a **relational database**.

187. Ans. A.

Access control based on a person's fingerprints is an example of **biometric identification**. **Biometrics** refers to metrics related to human characteristics. Biometrics authentication is used in computer science as a form of identification and access. It is also used to identify individuals in groups that are under surveillance.

188. Ans. B.

Query and reporting components implement the functionality to select, filter, view and present business data in a variety of readable formats.

189. Ans. C.

A **graphical user interface** (GUI) is a type of interface that allows users to interact with electronic devices through graphical icons and visual indicators such as secondary notation, as opposed to text-based interfaces typed command labels.

190. Ans. E.

Access Speed is the average amount of time it takes for a floppy drive, hard drive, CD drive, or other drive to find any particular piece of data on a disk and send it to your PC.

Note: Access speed is typically listed in milliseconds (ms).

191. Ans. E.

"Unsolicited Email" is **Spam**, which means an **unwanted email message** that forcing the recipient to assume the **cost of receiving**, storing and removing it from **one's email** box.

192. Ans. C.

In computer science, the general meaning of **input** is to provide or give something to the computer. Input devices are used for **sending instructions** to the computer.

193. Ans. E.

Main objective of the firewall is to control the incoming and outgoing network traffic by analyzing the data packets and determining whether it should be allowed through or not, based on the predetermined rule set.

194. Ans. A.

Toolbars contain small outlined areas called buttons that provide shortcuts for quick access to commonly used commands.

195. Ans. E.

ToggleKeys is a feature of **Microsoft Windows**. It is an accessibility function which is designed for people who have vision impairment or cognitive disabilities. When **ToggleKeys is turned on**, the computer will provide sound cues when the locking keys (Caps Lock, Num Lock, and Scroll Lock) are pressed. A high-pitched sound plays when the keys are switched on and a low-pitched sound plays when they are switched off.

196. Ans. A.

Microsoft **Windows** is a meta family of graphical **operating systems** developed, marketed and sold by **Microsoft**. It consists of several families of operating systems, each of which cater to a certain sector of the computing industry.

197. Ans. D.

HTML (**Hypertext Markup Language**) is the set of **markup symbols** inserted in a file intended for display on a World Wide Web browser page.

Note:- The markup tells the **Web browser** how to display a Web page's words and images for the user.

198. Ans. D.

The **Program counter** is an incrementing counter that **keeps track** of the **memory address** of the instruction that is to be executed next.

199. Ans. B.

To connect networks of similar protocols **Bridges** are used.

A **network bridge** is a **network device** that connects multiple **network** segments. In the OSI model, bridging is performed in the first two layers, below the **network** layer.

200. Ans. A.

The advantage of a LAN is sharing **peripherals**. Workstations can share peripheral devices like printers. This is cheaper than buying a printer for every workstation.



Latest Sarkari jobs, Govt Exam alerts, Results and Vacancies

- ▶ Latest News and Notification
- ▶ Exam Paper Analysis
- ▶ Topic-wise weightage
- ▶ Previous Year Papers with Answer Key
- ▶ Preparation Strategy & Subject-wise Books

To know more [Click Here](#)



www.prepp.in