

NEET 2023 Question Paper (Code H1)

Test Booklet No. **ENGLISH** Test Booklet Code **H1**

ADI

This Booklet contains **32** pages, including Rough Page.

Do not open this Test Booklet until you are asked to do so.

Important Instructions:

1. The Answer Sheet is inside this Test Booklet. When you are directed to open the Test Booklet, take out the Answer Sheet and fill in the particulars on ORIGINAL Copy carefully with **blue/black** ball point pen only.
2. The test is of **3 hours 20 minutes** duration and the Test Booklet contains **200** multiple-choice questions (four options with a single correct answer) from **Physics, Chemistry and Biology (Botany and Zoology)**. **50** questions in each subject are divided into **two Sections (A and B)** as per details given below:
 - (a) **Section A** shall consist of **35 (Thirty-five)** Questions in each subject (Question Nos – 1 to 35, 51 to 85, 101 to 135 and 151 to 185). All questions are compulsory.
 - (b) **Section B** shall consist of **15 (Fifteen)** questions in each subject (Question Nos – 36 to 50, 86 to 100, 136 to 150 and 186 to 200). In Section B, a candidate needs to **attempt any 10 (Ten)** questions out of **15 (Fifteen)** in each subject.

Candidates are advised to read all 15 questions in each subject of Section B before they start attempting the question paper. In the event of a candidate attempting more than ten questions, **the first ten questions answered by the candidate shall be evaluated.**
3. Each question carries **4** marks. For each correct response, the candidate will get **4** marks. For each incorrect response, **one** mark will be deducted from the total scores. **The maximum marks are 720.**
4. Use **Blue/Black Ball Point Pen only** for writing particulars on this page/markings responses on Answer Sheet.
5. Rough work is to be done in the space provided for this purpose in the Test Booklet only.
6. On completion of the test, the candidate **must hand over the Answer Sheet (ORIGINAL and OFFICE Copy) to the Invigilator** before leaving the Room/Hall. The candidates are allowed to take away this Test Booklet with them.
7. **The CODE for this Booklet is H1. Make sure that the CODE printed on the Original Copy of the Answer Sheet is the same as that on this Test Booklet.** In case of discrepancy, the candidate should immediately report the matter to the Invigilator for replacement of both the Test Booklet and the Answer Sheet.
8. The candidates should ensure that the Answer Sheet is not folded. Do not make any stray marks on the Answer Sheet. Do not write your Roll No. anywhere else except in the specified space in the Test Booklet/Answer Sheet.
9. Use of white fluid for correction is **NOT** permissible on the Answer Sheet.
10. Each candidate must show on-demand his/her Admit Card to the Invigilator.
11. No candidate, without special permission of the centre Superintendent or Invigilator, would leave his/her seat.
12. The candidates should not leave the Examination Hall without handing over their Answer Sheet to the Invigilator on duty and sign (with time) the Attendance Sheet **twice. Cases, where a candidate has not signed the Attendance Sheet second time, will be deemed not to have handed over the Answer Sheet and dealt with as an Unfair Means case.**
13. Use of Electronic/Manual Calculator is prohibited.
14. The candidates are governed by all Rules and Regulations of the examination with regard to their conduct in the Examination Room/Hall. All cases of unfair means will be dealt with as per the Rules and Regulations of this examination.
15. **No part of the Test Booklet and Answer Sheet shall be detached under any circumstances.**
16. The candidates will write the Correct Test Booklet Code as given in the Test Booklet/Answer Sheet in the Attendance Sheet.
17. Compensatory time of one hour five minutes will be provided for the examination of three hours and 20 minutes duration, whether such candidate (having a physical limitation to write) uses the facility of Scribe or not.

Name of the Candidate (in Capitals): _____

Roll Number : In figures _____

: In words _____

Centre of Examination (in Capitals): _____

Candidate's Signature: _____ Invigilator's Signature: _____

Facsimile signature stamp of Centre Superintendent

H1_English]

1

[Contd...

Physics : Section-A (Q. No. 1 to 35)

- 1 The ratio of radius of gyration of a solid sphere of mass M and radius R about its own axis to the radius of gyration of the thin hollow sphere of same mass and radius about its axis is :
- (1) 2 : 5 (2) 5 : 2
(3) 3 : 5 (4) 5 : 3
- 2 The magnetic energy stored in an inductor of inductance $4 \mu\text{H}$ carrying a current of 2 A is :
- (1) 8 mJ (2) $8 \mu\text{J}$
(3) $4 \mu\text{J}$ (4) 4 mJ
- 3 A full wave rectifier circuit consists of two p-n junction diodes, a centre-tapped transformer, capacitor and a load resistance. Which of these components remove the ac ripple from the rectified output?
- (1) Capacitor
(2) Load resistance
(3) A centre-tapped transformer
(4) p-n junction diodes
- 4 An electric dipole is placed at an angle of 30° with an electric field of intensity $2 \times 10^5 \text{ N C}^{-1}$. It experiences a torque equal to 4 N m . Calculate the magnitude of charge on the dipole, if the dipole length is 2 cm .
- (1) 4 mC (2) 2 mC
(3) 8 mC (4) 6 mC
- 5 The equivalent capacitance of the system shown in the following circuit is :

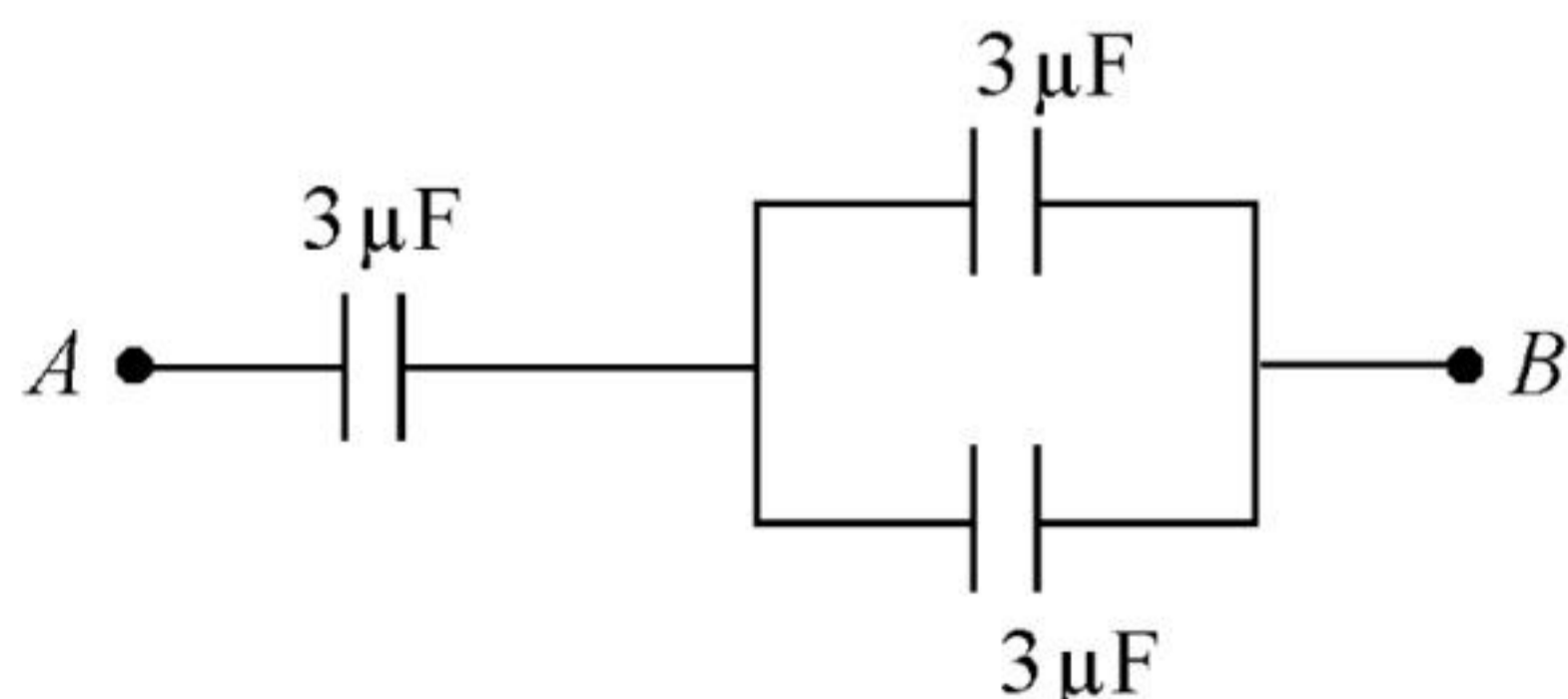

- (1) $6 \mu\text{F}$ (2) $9 \mu\text{F}$
(3) $2 \mu\text{F}$ (4) $3 \mu\text{F}$

- 6 In hydrogen spectrum, the shortest wavelength in the Balmer series is λ . The shortest wavelength in the Bracket series is :
- (1) 9λ (2) 16λ
(3) 2λ (4) 4λ
- 7 Resistance of a carbon resistor determined from colour codes is $(22000 \pm 5\%) \Omega$. The colour of third band must be :
- (1) Orange (2) Yellow
(3) Red (4) Green
- 8 Two bodies of mass m and $9m$ are placed at a distance R . The gravitational potential on the line joining the bodies where the gravitational field equals zero, will be ($G =$ gravitational constant) :
- (1) $-\frac{16 Gm}{R}$ (2) $-\frac{20 Gm}{R}$
(3) $-\frac{8 Gm}{R}$ (4) $-\frac{12 Gm}{R}$
- 9 If the galvanometer G does not show any deflection in the circuit shown, the value of R is given by :

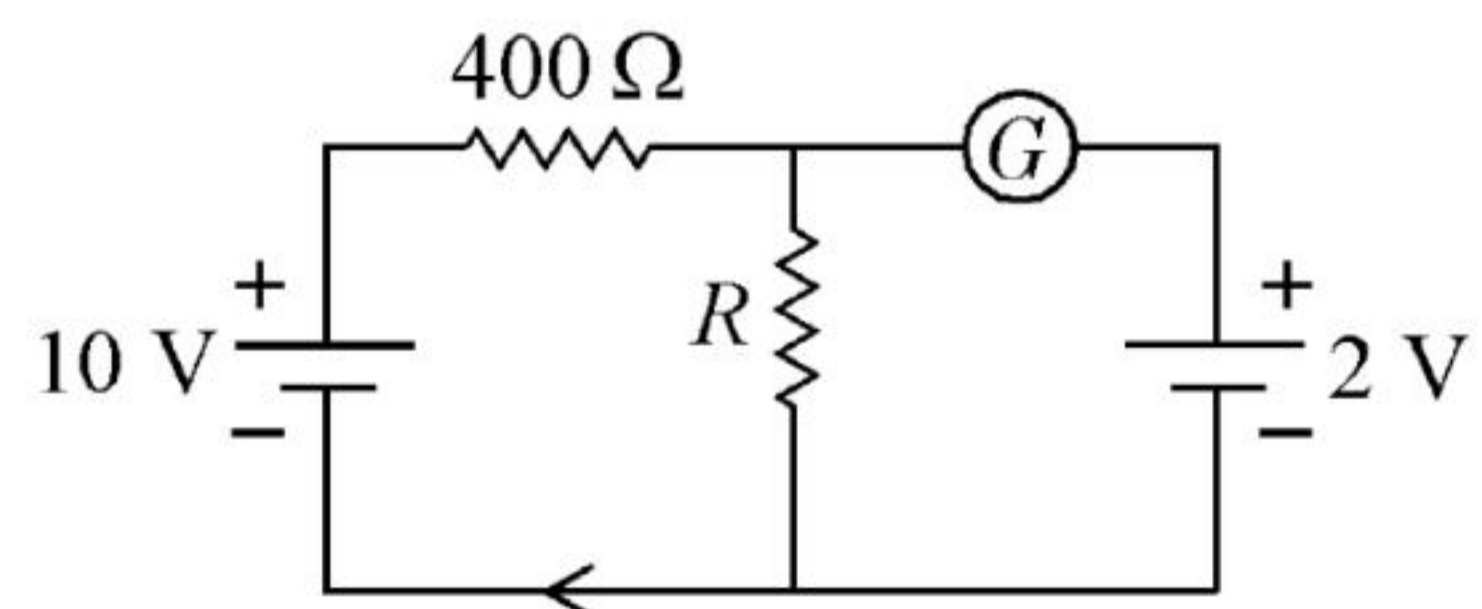

- (1) 100Ω (2) 400Ω
(3) 200Ω (4) 50Ω

- 10 For Young's double slit experiment, two statements are given below:
Statement I : If screen is moved away from the plane of slits, angular separation of the fringes remains constant.
Statement II : If the monochromatic source is replaced by another monochromatic source of larger wavelength, the angular separation of fringes decreases.
 In the light of the above statements, choose the *correct* answer from the options given below:
- (1) **Statement I** is true but **Statement II** is false.
 - (2) **Statement I** is false but **Statement II** is true.
 - (3) Both **Statement I** and **Statement II** are true.
 - (4) Both **Statement I** and **Statement II** are false.
- 11 The venturi-meter works on :
- (1) The principle of parallel axes
 - (2) The principle of perpendicular axes
 - (3) Huygen's principle
 - (4) Bernoulli's principle
- 12 Let a wire be suspended from the ceiling (rigid support) and stretched by a weight W attached at its free end. The longitudinal stress at any point of cross-sectional area A of the wire is :
- (1) $W/2A$ (2) Zero
 - (3) $2W/A$ (4) W/A
- 13 The angular acceleration of a body, moving along the circumference of a circle, is :
- (1) along the tangent to its position
 - (2) along the axis of rotation
 - (3) along the radius, away from centre
 - (4) along the radius towards the centre
- 14 The temperature of a gas is -50°C . To what temperature the gas should be heated so that the rms speed is increased by 3 times?
- (1) 3097 K (2) 223 K
 - (3) 669°C (4) 3295°C
- 15 The work functions of Caesium (Cs), Potassium (K) and Sodium (Na) are 2.14 eV, 2.30 eV and 2.75 eV respectively. If incident electromagnetic radiation has an incident energy of 2.20 eV, which of these photosensitive surfaces may emit photoelectrons?
- (1) K only
 - (2) Na only
 - (3) Cs only
 - (4) Both Na and K
- 16 An ac source is connected to a capacitor C . Due to decrease in its operating frequency :
- (1) displacement current decreases.
 - (2) capacitive reactance remains constant
 - (3) capacitive reactance decreases.
 - (4) displacement current increases.
- 17 Light travels a distance x in time t_1 in air and $10x$ in time t_2 in another denser medium. What is the critical angle for this medium?
- (1) $\sin^{-1}\left(\frac{t_1}{10t_2}\right)$ (2) $\sin^{-1}\left(\frac{10t_1}{t_2}\right)$
 - (3) $\sin^{-1}\left(\frac{t_2}{t_1}\right)$ (4) $\sin^{-1}\left(\frac{10t_2}{t_1}\right)$
- 18 The net magnetic flux through any closed surface is :
- (1) Infinity (2) Negative
 - (3) Zero (4) Positive

- 19 A 12 V, 60 W lamp is connected to the secondary of a step down transformer, whose primary is connected to ac mains of 220 V. Assuming the transformer to be ideal, what is the current in the primary winding?
 (1) 3.7 A (2) 0.37 A
 (3) 0.27 A (4) 2.7 A
- 20 A metal wire has mass (0.4 ± 0.002) g, radius (0.3 ± 0.001) mm and length (5 ± 0.02) cm. The maximum possible percentage error in the measurement of density will nearly be:
 (1) 1.6% (2) 1.4%
 (3) 1.2% (4) 1.3%
- 21 Given below are two statements:
Statement I : Photovoltaic devices can convert optical radiation into electricity.
Statement II : Zener diode is designed to operate under reverse bias in breakdown region.
 In the light of the above statements, choose the *most appropriate* answer from the options given below :
 (1) **Statement I** is correct but **Statement II** is incorrect.
 (2) **Statement I** is incorrect but **Statement II** is correct.
 (3) Both **Statement I** and **Statement II** are correct.
 (4) Both **Statement I** and **Statement II** are incorrect.
- 22 A bullet is fired from a gun at the speed of 280 m s^{-1} in the direction 30° above the horizontal. The maximum height attained by the bullet is $(g = 9.8 \text{ m s}^{-2}, \sin 30^\circ = 0.5)$:
 (1) 1000 m (2) 3000 m
 (3) 2800 m (4) 2000 m
- 23 A Carnot engine has an efficiency of 50% when its source is at a temperature 327° C . The temperature of the sink is :
 (1) 100° C (2) 200° C
 (3) 27° C (4) 15° C
- 24 The amount of energy required to form a soap bubble of radius 2 cm from a soap solution is nearly : (surface tension of soap solution = 0.03 N m^{-1})
 (1) $3.01 \times 10^{-4} \text{ J}$ (2) $50.1 \times 10^{-4} \text{ J}$
 (3) $30.16 \times 10^{-4} \text{ J}$ (4) $5.06 \times 10^{-4} \text{ J}$
- 25 The minimum wavelength of X-rays produced by an electron accelerated through a potential difference of V volts is proportional to:
 (1) $\frac{1}{\sqrt{V}}$ (2) V^2
 (3) \sqrt{V} (4) $\frac{1}{V}$
- 26 In a series LCR circuit, the inductance L is 10 mH, capacitance C is $1 \mu\text{F}$ and resistance R is 100Ω . The frequency at which resonance occurs is :
 (1) 1.59 rad/s (2) 1.59 kHz
 (3) 15.9 rad/s (4) 15.9 kHz
- 27 The potential energy of a long spring when stretched by 2 cm is U . If the spring is stretched by 8 cm, potential energy stored in it will be :
 (1) $8U$ (2) $16U$
 (3) $2U$ (4) $4U$



28 The half life of a radioactive substance is 20 minutes. In how much time, the activity of substance drops to $\left(\frac{1}{16}\right)^{th}$ of its initial value?

- (1) 60 minutes (2) 80 minutes
(3) 20 minutes (4) 40 minutes

29 If $\oint_s \vec{E} \cdot d\vec{S} = 0$ over a surface, then :

- (1) all the charges must necessarily be inside the surface.
(2) the electric field inside the surface is necessarily uniform.
(3) the number of flux lines entering the surface must be equal to the number of flux lines leaving it.
(4) the magnitude of electric field on the surface is constant.

30 The ratio of frequencies of fundamental harmonic produced by an open pipe to that of closed pipe having the same length is :

- (1) 1 : 3 (2) 3 : 1
(3) 1 : 2 (4) 2 : 1

31 The errors in the measurement which arise due to unpredictable fluctuations in temperature and voltage supply are :

- (1) Least count errors
(2) Random errors
(3) Instrumental errors
(4) Personal errors

32 In a plane electromagnetic wave travelling in free space, the electric field component oscillates sinusoidally at a frequency of 2.0×10^{10} Hz and amplitude 48 V m^{-1} . Then the amplitude of oscillating magnetic field is : (Speed of light in free space = $3 \times 10^8 \text{ m s}^{-1}$)

- (1) $1.6 \times 10^{-7} \text{ T}$ (2) $1.6 \times 10^{-6} \text{ T}$
(3) $1.6 \times 10^{-9} \text{ T}$ (4) $1.6 \times 10^{-8} \text{ T}$

33 A football player is moving southward and suddenly turns eastward with the same speed to avoid an opponent. The force that acts on the player while turning is :

- (1) along north-east
(2) along south-west
(3) along eastward
(4) along northward

34 The magnitude and direction of the current in the following circuit is

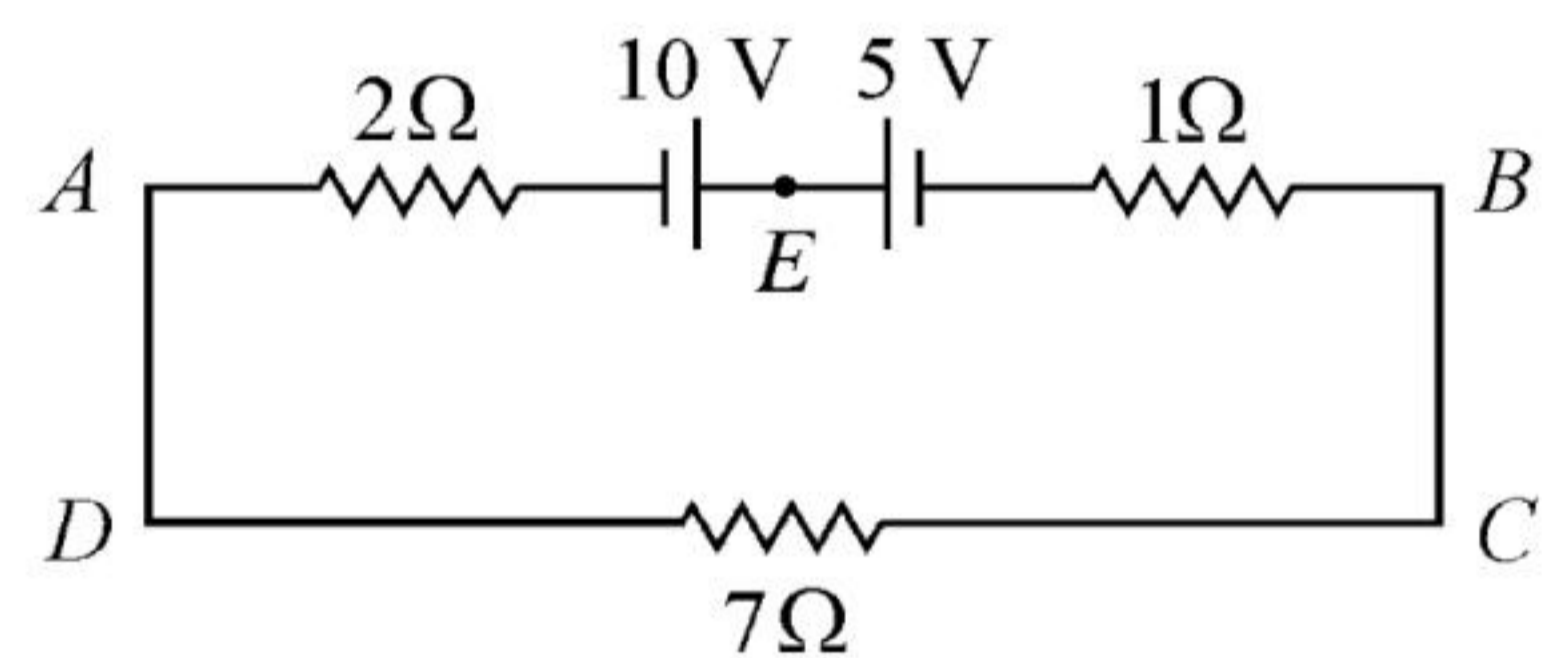

- (1) $\frac{5}{9}$ A from A to B through E
(2) 1.5 A from B to A through E
(3) 0.2 A from B to A through E
(4) 0.5 A from A to B through E

35 A vehicle travels half the distance with speed ϑ and the remaining distance with speed 2ϑ . Its average speed is:

- (1) $\frac{4\vartheta}{3}$ (2) $\frac{3\vartheta}{4}$
(3) $\frac{\vartheta}{3}$ (4) $\frac{2\vartheta}{3}$

Physics : Section-B (Q. No. 36 to 50)

36 The radius of inner most orbit of hydrogen atom is 5.3×10^{-11} m. What is the radius of third allowed orbit of hydrogen atom?

- (1) 1.59 \AA (2) 4.77 \AA
 (3) 0.53 \AA (4) 1.06 \AA

37 10 resistors, each of resistance R are connected in series to a battery of emf E and negligible internal resistance. Then those are connected in parallel to the same battery, the current is increased n times. The value of n is :

- (1) 1 (2) 1000
 (3) 10 (4) 100

38 The $x-t$ graph of a particle performing simple harmonic motion is shown in the figure. The acceleration of the particle at $t = 2$ s is :

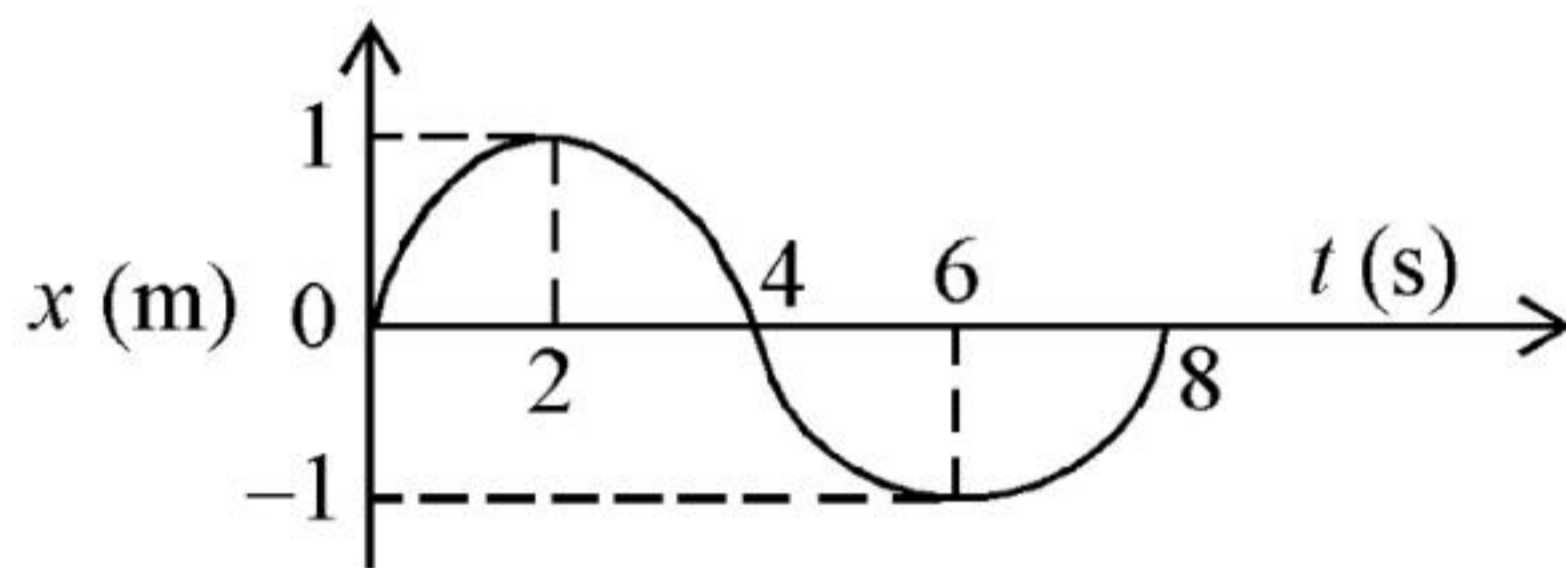

- (1) $\frac{\pi^2}{16} \text{ m s}^{-2}$ (2) $-\frac{\pi^2}{16} \text{ m s}^{-2}$
 (3) $\frac{\pi^2}{8} \text{ m s}^{-2}$ (4) $-\frac{\pi^2}{8} \text{ m s}^{-2}$

39 Two thin lenses are of same focal lengths (f), but one is convex and the other one is concave. When they are placed in contact with each other, the equivalent focal length of the combination will be :

- (1) $f/2$ (2) Infinite
 (3) Zero (4) $f/4$

40 A satellite is orbiting just above the surface of the earth with period T . If d is the density of the earth and G is the universal constant of gravitation, the quantity $\frac{3\pi}{Gd}$ represents :

- (1) T^3 (2) \sqrt{T}
 (3) T (4) T^2

41 Calculate the maximum acceleration of a moving car so that a body lying on the floor of the car remains stationary. The coefficient of static friction between the body and the floor is 0.15 ($g = 10 \text{ m s}^{-2}$).

- (1) 1.5 m s^{-2} (2) 50 m s^{-2}
 (3) 1.2 m s^{-2} (4) 150 m s^{-2}

42 An electric dipole is placed as shown in the figure.

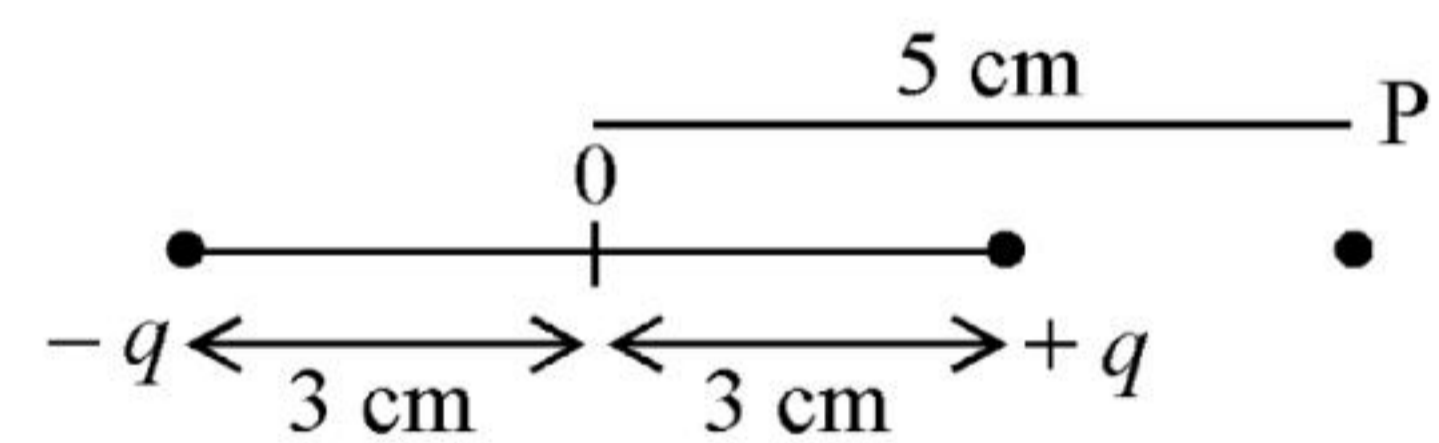

The electric potential (in 10^2 V) at point P due to the dipole is ($\epsilon_0 =$ permittivity of free space and $\frac{1}{4\pi\epsilon_0} = K$):

- (1) $\left(\frac{8}{5}\right) qK$ (2) $\left(\frac{8}{3}\right) qK$
 (3) $\left(\frac{3}{8}\right) qK$ (4) $\left(\frac{5}{8}\right) qK$

43 The net impedance of circuit (as shown in figure) will be :

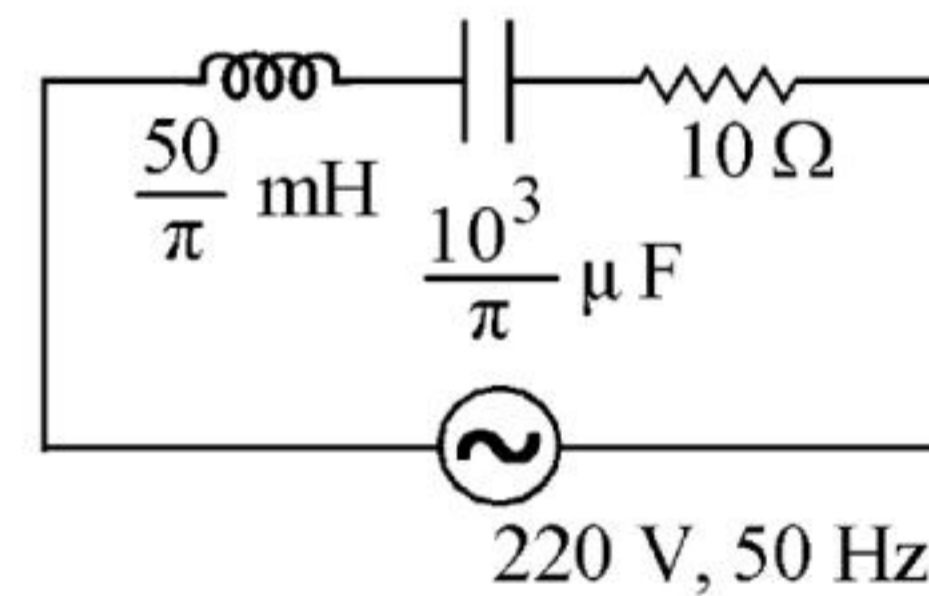

- (1) $5\sqrt{5} \Omega$ (2) 25Ω
 (3) $10\sqrt{2} \Omega$ (4) 15Ω

- 44 For the following logic circuit, the truth table is:

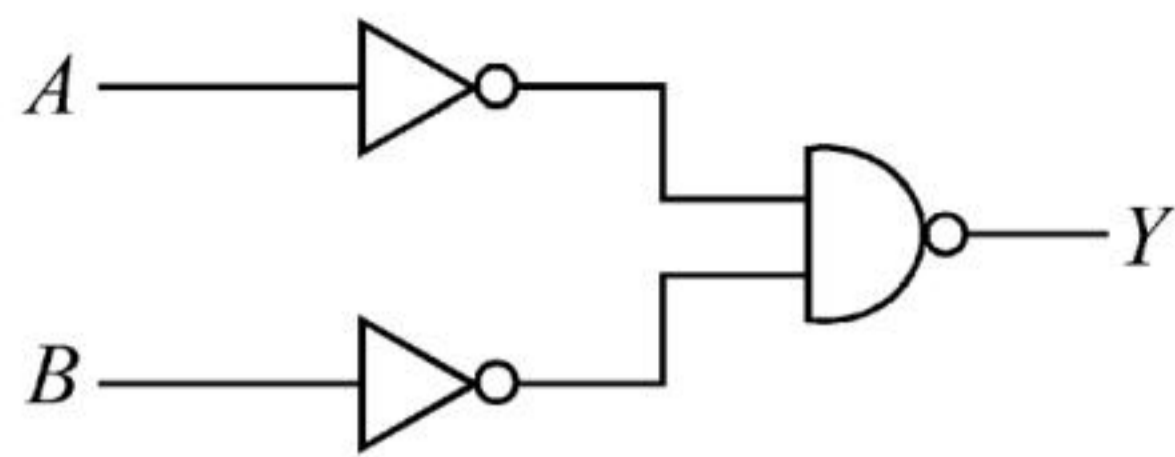

- (1)

A	B	Y
0	0	1
0	1	0
1	0	1
1	1	0
- (2)

A	B	Y
0	0	0
0	1	0
1	0	0
1	1	1
- (3)

A	B	Y
0	0	1
0	1	1
1	0	1
1	1	0
- (4)

A	B	Y
0	0	0
0	1	1
1	0	1
1	1	1

- 45 In the figure shown here, what is the equivalent focal length of the combination of lenses (Assume that all layers are thin)?

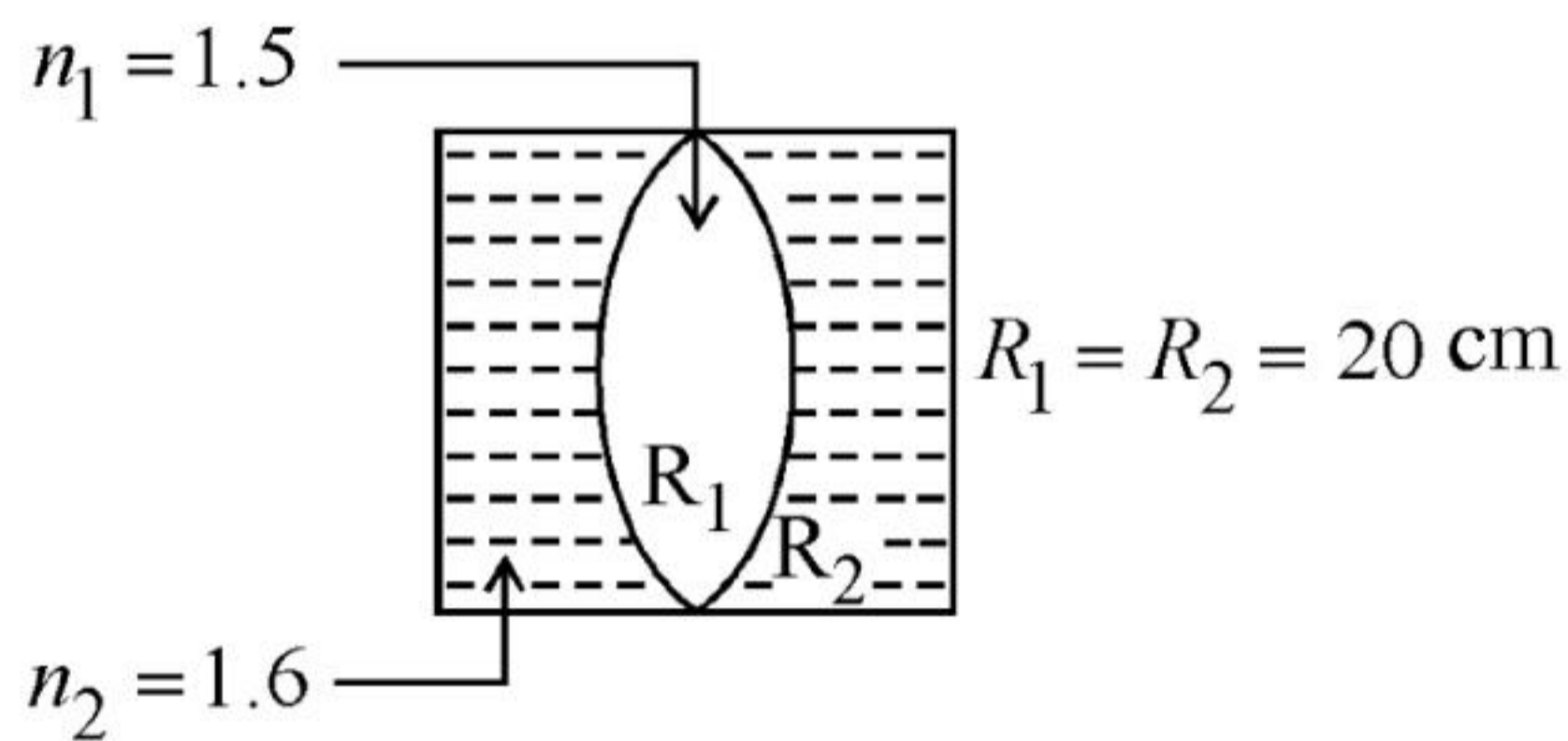

- (1) -100 cm (2) -50 cm
(3) 40 cm (4) -40 cm
- 46 A bullet from a gun is fired on a rectangular wooden block with velocity u . When bullet travels 24 cm through the block along its length horizontally, velocity of bullet becomes $\frac{u}{3}$. Then it further penetrates into the block in the same direction before coming to rest exactly at the other end of the block. The total length of the block is :
- (1) 28 cm (2) 30 cm
(3) 27 cm (4) 24 cm
- 47 The resistance of platinum wire at 0°C is 2Ω and 6.8Ω at 80°C . The temperature coefficient of resistance of the wire is :
- (1) $3 \times 10^{-2} \text{ }^\circ\text{C}^{-1}$ (2) $3 \times 10^{-1} \text{ }^\circ\text{C}^{-1}$
(3) $3 \times 10^{-4} \text{ }^\circ\text{C}^{-1}$ (4) $3 \times 10^{-3} \text{ }^\circ\text{C}^{-1}$

- 48 A horizontal bridge is built across a river. A student standing on the bridge throws a small ball vertically upwards with a velocity 4 m s^{-1} . The ball strikes the water surface after 4 s. The height of bridge above water surface is (Take $g = 10 \text{ m s}^{-2}$) :

- (1) 64 m (2) 68 m
(3) 56 m (4) 60 m

- 49 A very long conducting wire is bent in a semi-circular shape from A to B as shown in figure. The magnetic field at point P for steady current configuration is given by :

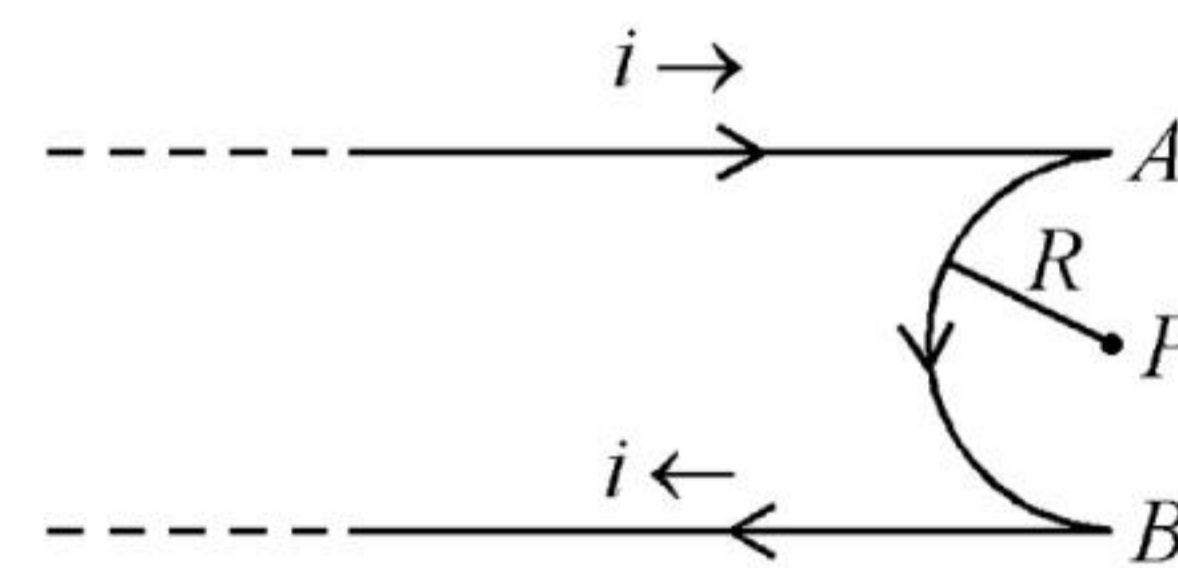

- (1) $\frac{\mu_0 i}{4R} \left[1 - \frac{2}{\pi} \right]$ pointed away from page
(2) $\frac{\mu_0 i}{4R} \left[1 - \frac{2}{\pi} \right]$ pointed into the page
(3) $\frac{\mu_0 i}{4R}$ pointed into the page
(4) $\frac{\mu_0 i}{4R}$ pointed away from the page

- 50 A wire carrying a current I along the positive x -axis has length L . It is kept in a magnetic field $\vec{B} = (2\hat{i} + 3\hat{j} - 4\hat{k}) \text{ T}$. The magnitude of the magnetic force acting on the wire is :

- (1) $5 IL$ (2) $\sqrt{3} IL$
(3) $3 IL$ (4) $\sqrt{5} IL$

Chemistry : Section-A (Q. No. 51 to 85)

- 51** Given below are two statements : one is labelled as **Assertion A** and the other is labelled as **Reason R** :

Assertion A : A reaction can have zero activation energy.

Reasons R : The minimum extra amount of energy absorbed by reactant molecules so that their energy becomes equal to threshold value, is called activation energy.

In the light of the above statements, choose the **correct** answer from the options given below :

- (1) **A** is true but **R** is false.
- (2) **A** is false but **R** is true.
- (3) Both **A** and **R** are true and **R** is the correct explanation of **A**.
- (4) Both **A** and **R** are true and **R** is **NOT** the correct explanation of **A**.

- 52** The **correct** order of energies of molecular orbitals of N_2 molecule, is :

- (1) $\sigma 1s < \sigma^* 1s < \sigma 2s < \sigma^* 2s < \sigma 2p_z < \sigma^* 2p_z < (\pi 2p_x = \pi 2p_y) < (\pi^* 2p_x = \pi^* 2p_y)$
- (2) $\sigma 1s < \sigma^* 1s < \sigma 2s < \sigma^* 2s < (\pi 2p_x = \pi 2p_y) < (\pi^* 2p_x = \pi^* 2p_y) < \sigma 2p_z < \sigma^* 2p_z$
- (3) $\sigma 1s < \sigma^* 1s < \sigma 2s < \sigma^* 2s < (\pi 2p_x = \pi 2p_y) < \sigma 2p_z < (\pi^* 2p_x = \pi^* 2p_y) < \sigma^* 2p_z$
- (4) $\sigma 1s < \sigma^* 1s < \sigma 2s < \sigma^* 2s < \sigma 2p_z < (\pi 2p_x = \pi 2p_y) < (\pi^* 2p_x = \pi^* 2p_y) < \sigma^* 2p_z$

- 53** The given compound

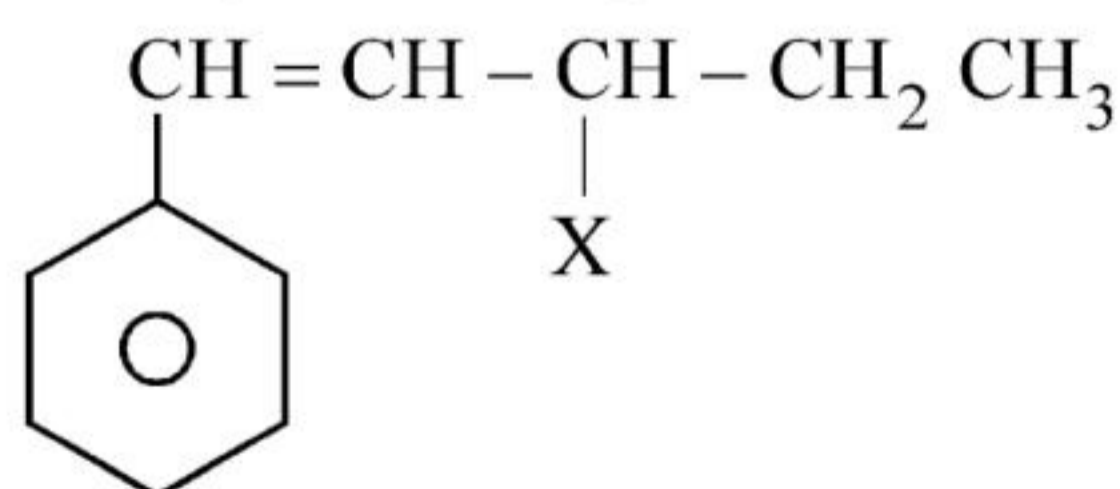

is an example of _____.

- (1) allylic halide
- (2) vinylic halide
- (3) benzylic halide
- (4) aryl halide

- 54** Homoleptic complex from the following complexes is :

- (1) Pentaamminecarbonatocobalt (III) chloride
- (2) Triamminetriaquachromium (III) chloride
- (3) Potassium trioxalatoaluminate (III)
- (4) Diamminechloridonitrito - N - platinum (II)

- 55** The **right** option for the mass of CO_2 produced by heating 20 g of 20% pure limestone is (Atomic mass of Ca = 40)

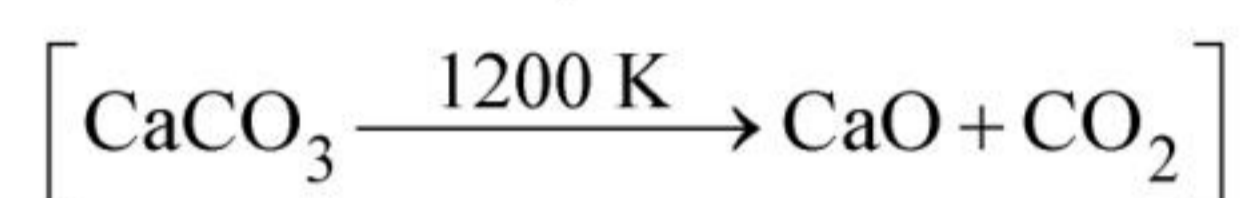

- (1) 2.64 g
- (2) 1.32 g
- (3) 1.12 g
- (4) 1.76 g

- 56** The relation between n_m , (n_m = the number of permissible values of magnetic quantum number (m)) for a given value of azimuthal quantum number (l), is

- (1) $n_m = 2l^2 + 1$
- (2) $n_m = l + 2$
- (3) $l = \frac{n_m - 1}{2}$
- (4) $l = 2n_m + 1$

- 57** Select the **correct** statements from the following :

- A. Atoms of all elements are composed of two fundamental particles.
- B. The mass of the electron is 9.10939×10^{-31} kg.
- C. All the isotopes of a given element show same chemical properties.
- D. Protons and electrons are collectively known as nucleons.
- E. Dalton's atomic theory, regarded the atom as an ultimate particle of matter.

Choose the **correct** answer from the options given below :

- (1) A and E only
- (2) B, C and E only
- (3) A, B and C only
- (4) C, D and E only



58 Which one is an example of heterogenous catalysis?

- (1) Decomposition of ozone in presence of nitrogen monoxide.
- (2) Combination between dinitrogen and dihydrogen to form ammonia in the presence of finely divided iron.
- (3) Oxidation of sulphur dioxide into sulphur trioxide in the presence of oxides of nitrogen.
- (4) Hydrolysis of sugar catalysed by H^+ ions.

59 Weight (g) of two moles of the organic compound, which is obtained by heating sodium ethanoate with sodium hydroxide in presence of calcium oxide is :

- (1) 30
- (2) 18
- (3) 16
- (4) 32

60 The number of σ bonds, π bonds and lone pair of electrons in pyridine, respectively are:

- (1) 11, 3, 1
- (2) 12, 2, 1
- (3) 11, 2, 0
- (4) 12, 3, 0

61 Which amongst the following molecules on polymerization produces neoprene?

- (1) $H_2C = CH - C \equiv CH$
- (2) $H_2C = \overset{\text{CH}_3}{\underset{|}{C}} - CH = CH_2$
- (3) $H_2C = CH - CH = CH_2$
- (4) $H_2C = \overset{\text{Cl}}{\underset{|}{C}} - CH = CH_2$

62 The stability of Cu^{2+} is more than Cu^+ salts in aqueous solution due to -

- (1) hydration energy.
- (2) second ionisation enthalpy.
- (3) first ionisation enthalpy.
- (4) enthalpy of atomization.

63 Complete the following reaction :

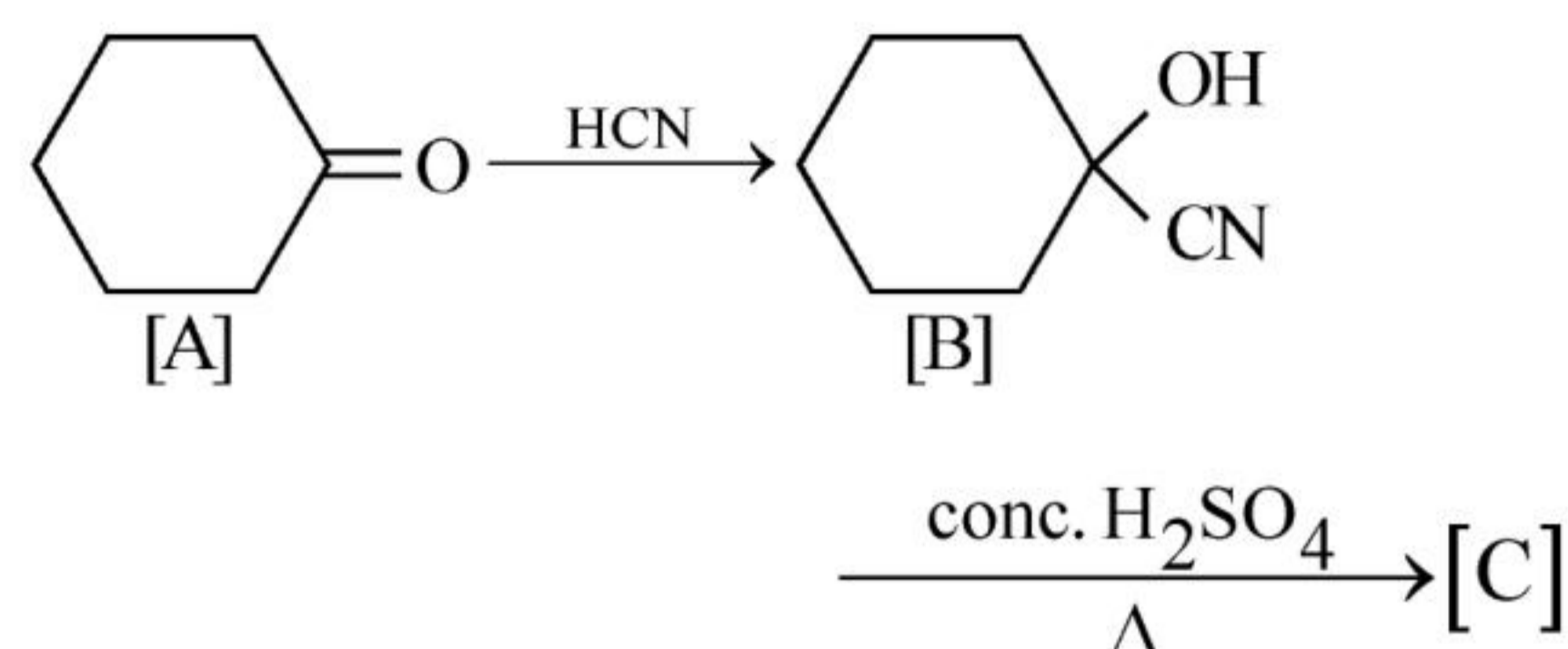

[C] is _____.

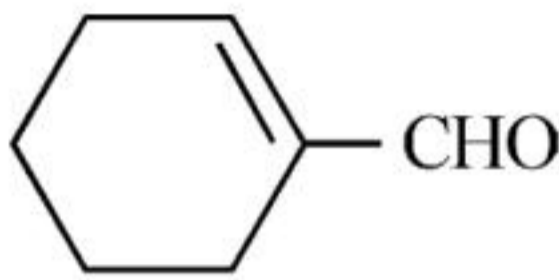
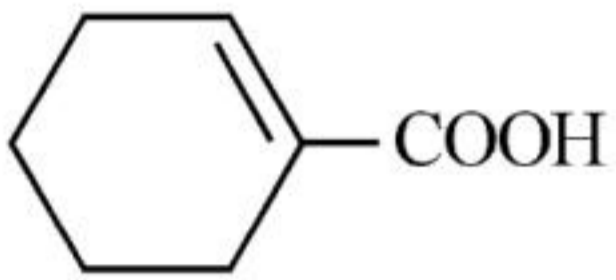
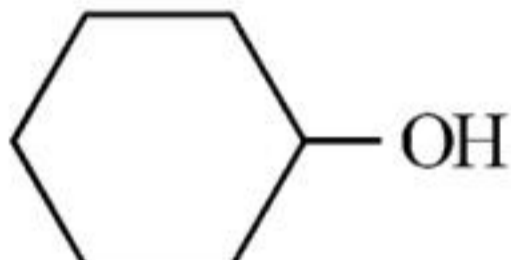
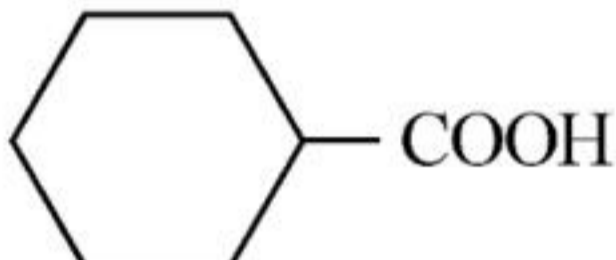
- (1)  (2) 
- (3)  (4) 

64 Which of the following reactions will NOT give primary amine as the product?

- (1) $CH_3NC \xrightarrow[\text{(ii) } H_3O^+]{\text{(i) } LiAlH_4} \text{Product}$
- (2) $CH_3CONH_2 \xrightarrow[\text{(ii) } H_3O^+]{\text{(i) } LiAlH_4} \text{Product}$
- (3) $CH_3CONH_2 \xrightarrow{Br_2 / KOH} \text{Product}$
- (4) $CH_3CN \xrightarrow[\text{(ii) } H_3O^+]{\text{(i) } LiAlH_4} \text{Product}$

65 Given below are two statements : one is labelled as **Assertion A** and the other is labelled as **Reason R** :

Assertion A : Helium is used to dilute oxygen in diving apparatus.



Reasons R : Helium has high solubility in O_2 .

In the light of the above statements, choose the **correct** answer from the options given below :

- (1) **A** is true but **R** is false.
- (2) **A** is false but **R** is true.
- (3) Both **A** and **R** are true and **R** is the correct explanation of **A**.
- (4) Both **A** and **R** are true and **R** is **NOT** the correct explanation of **A**.

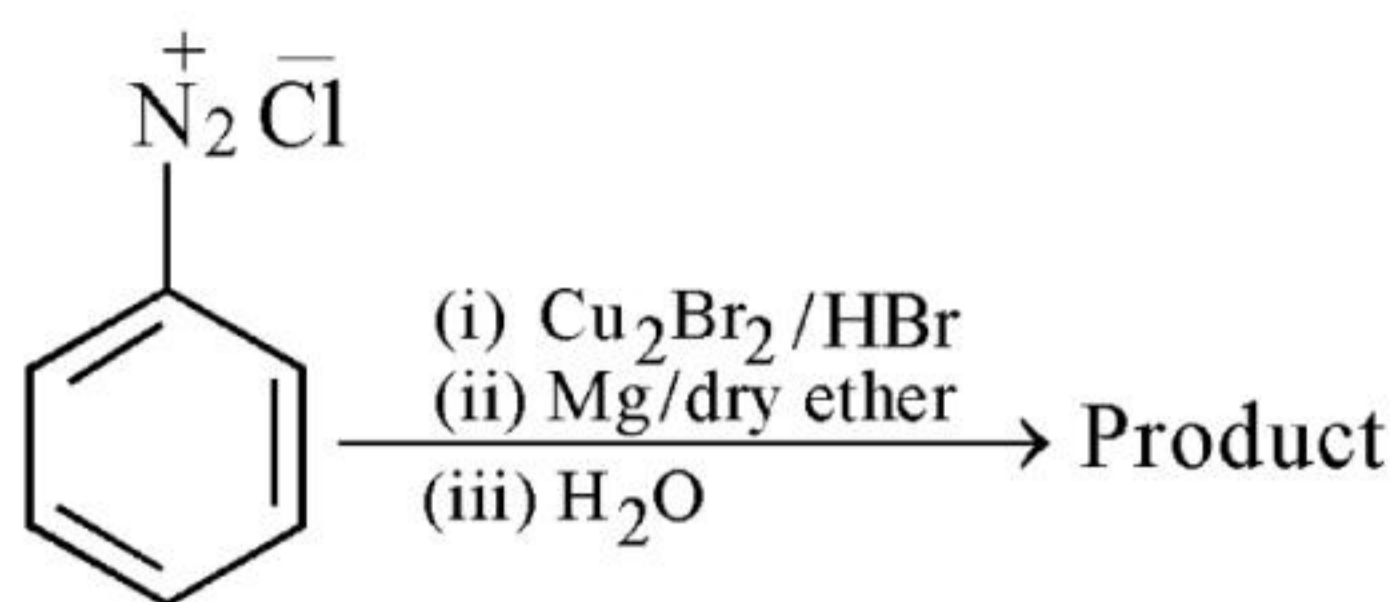
66 Identify the product in the following reaction:

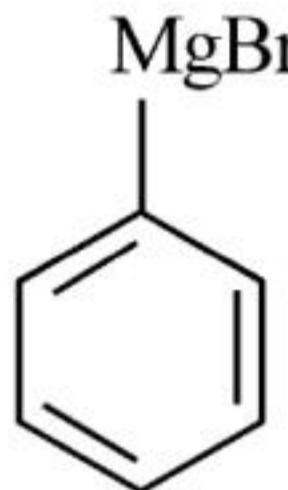
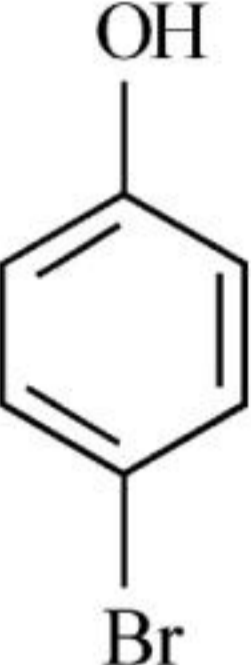
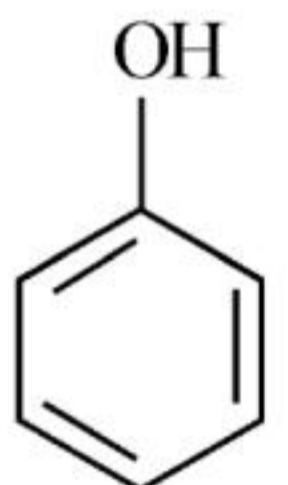

- (1) 
- (2) 
- (3) 
- (4) 

67 Consider the following reaction and identify the product (P).

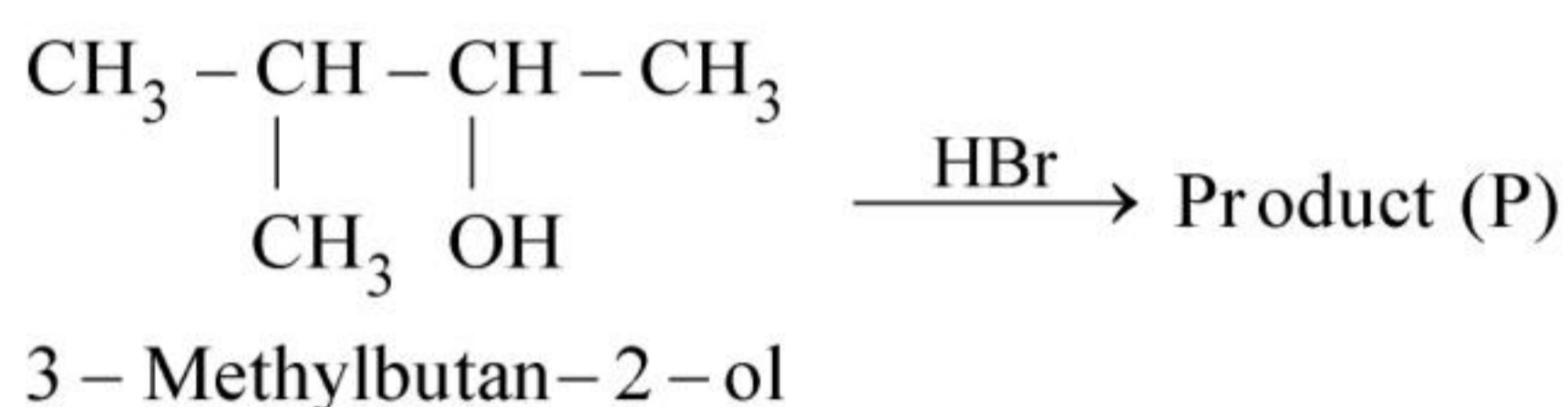

- (1) $\begin{array}{c} \text{CH}_3 - \text{CH} - \text{CH} - \text{CH}_3 \\ | \quad | \\ \text{CH}_3 \quad \text{Br} \end{array}$
- (2) $\begin{array}{c} \text{CH}_3 \\ | \\ \text{CH}_3 - \text{C} - \text{CH}_2 \text{ Br} \\ | \\ \text{CH}_3 \end{array}$
- (3) $\begin{array}{c} \text{Br} \\ | \\ \text{CH}_3 - \text{C} - \text{CH}_2 - \text{CH}_3 \\ | \\ \text{CH}_3 \end{array}$
- (4) $\text{CH}_3 \text{CH} = \text{CH} - \text{CH}_3$

68 Identify product (A) in the following reaction:

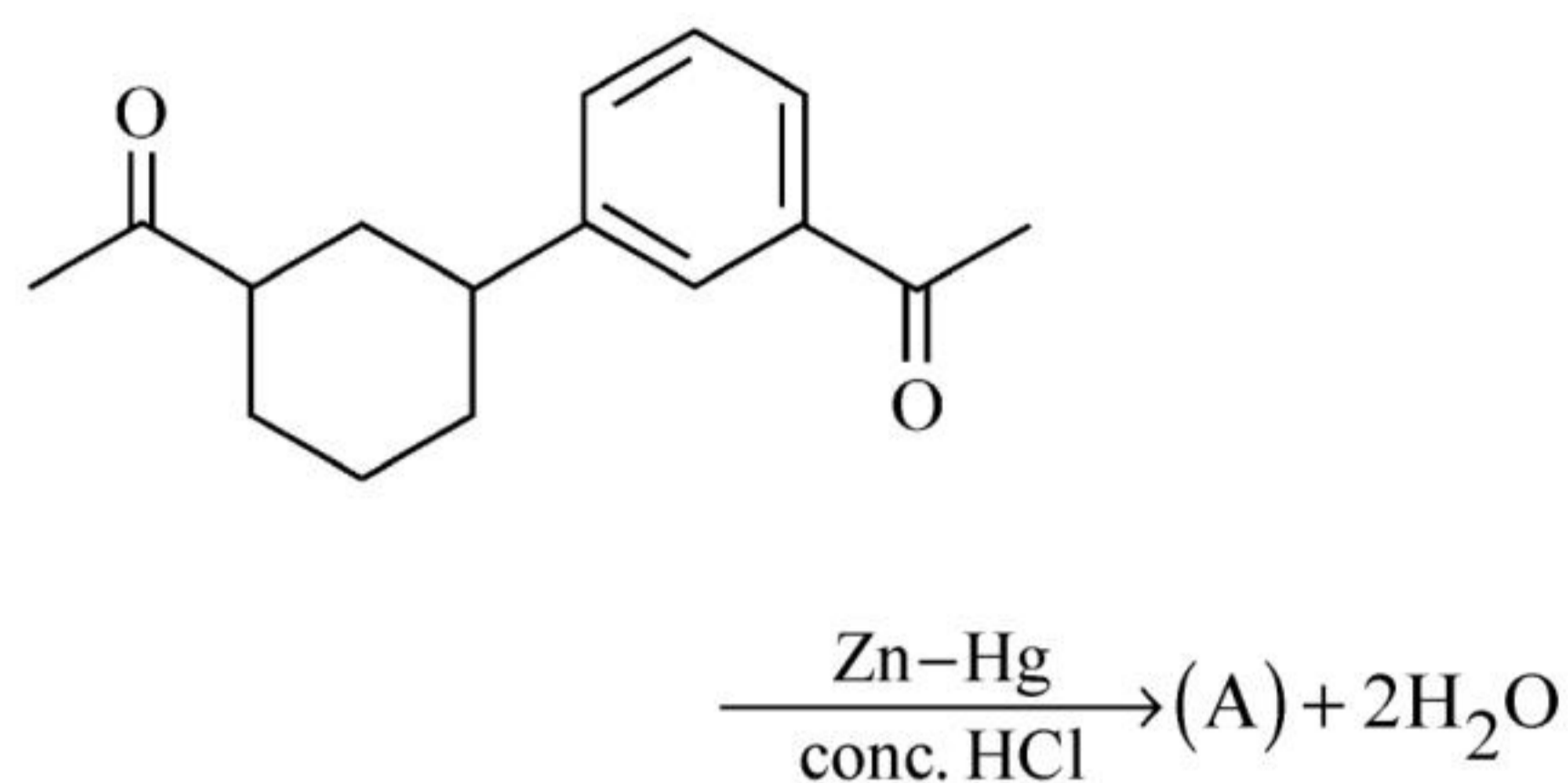

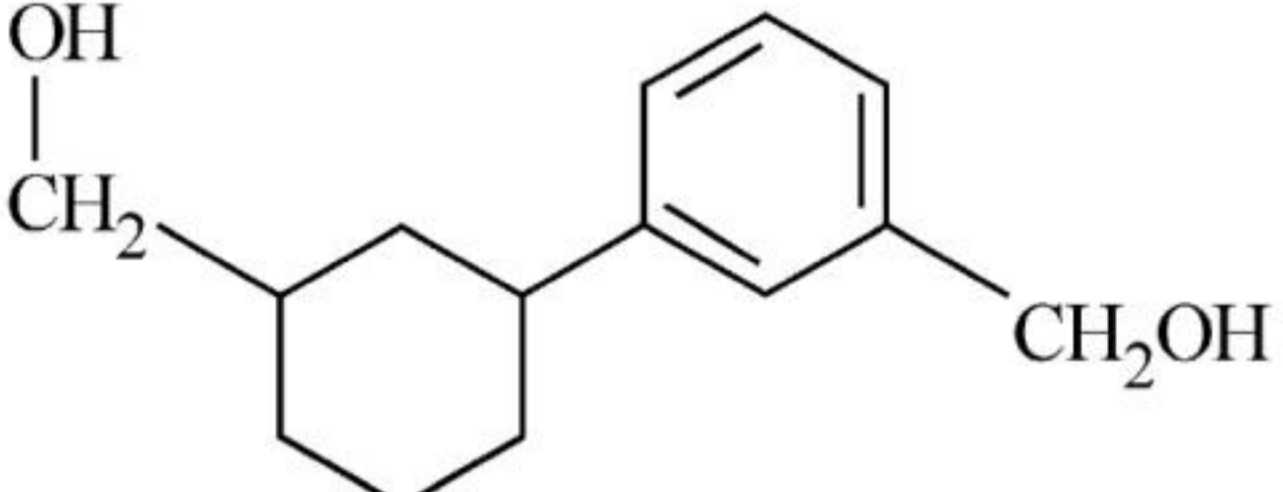
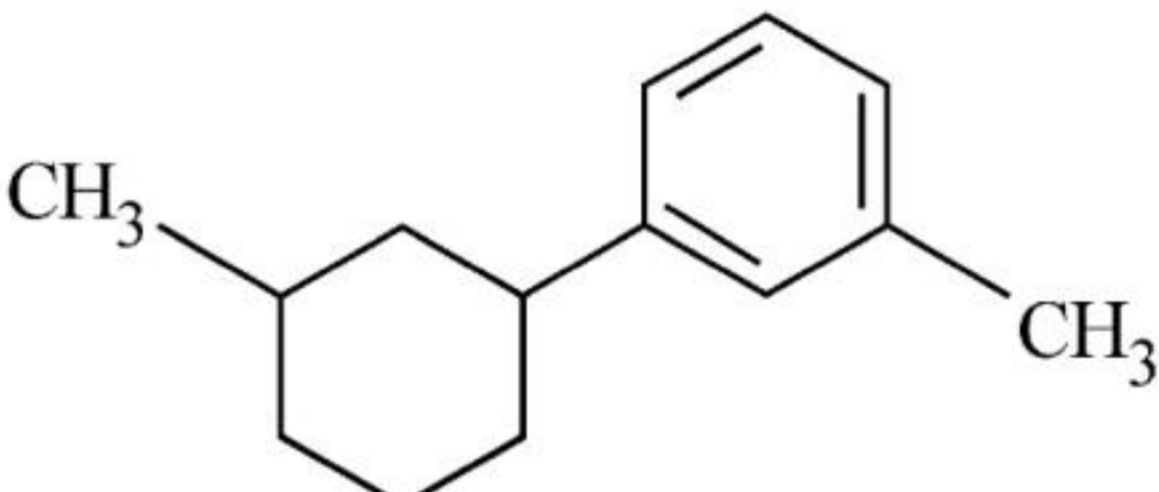
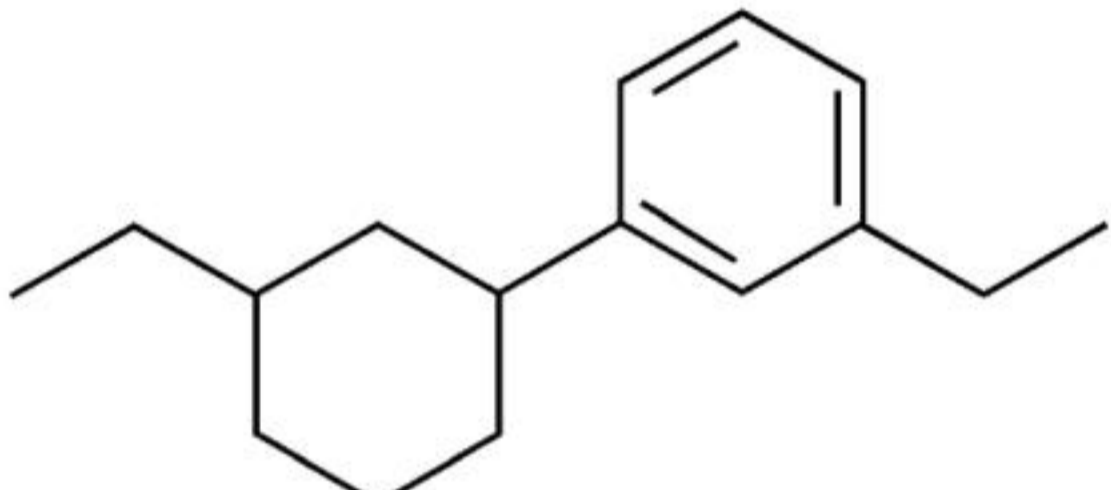
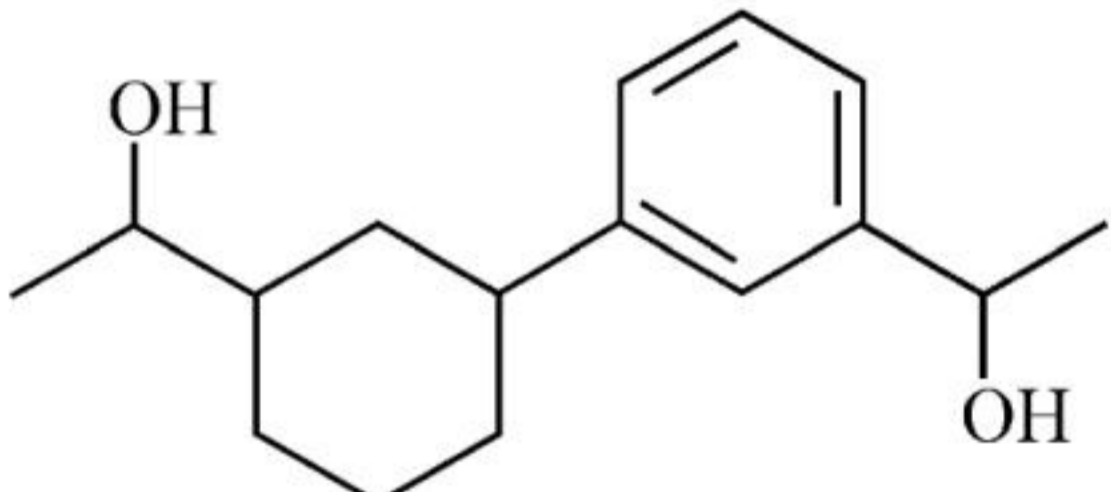
- (1) 
- (2) 
- (3) 
- (4) 

69 Taking stability as the factor, which one of the following represents **correct** relationship?

- (1) $\text{AlCl} > \text{AlCl}_3$
- (2) $\text{TlI} > \text{TlI}_3$
- (3) $\text{TlCl}_3 > \text{TlCl}$
- (4) $\text{InI}_3 > \text{InI}$

70 The conductivity of centimolar solution of KCl at 25°C is $0.0210 \text{ ohm}^{-1} \text{ cm}^{-1}$ and the resistance of the cell containing the solution at 25°C is 60 ohm. The value of cell constant is -

- (1) 1.26 cm^{-1} (2) 3.34 cm^{-1}
(3) 1.34 cm^{-1} (4) 3.28 cm^{-1}

71 Which one of the following statements is **correct**?

- (1) The bone in human body is an inert and unchanging substance.
(2) Mg plays roles in neuromuscular function and interneuronal transmission.
(3) The daily requirement of Mg and Ca in the human body is estimated to be 0.2 - 0.3 g.
(4) All enzymes that utilise ATP in phosphate transfer require Ca as the cofactor.

72 Match **List - I** with **List - II** :

List - I	List - II
A. Coke	I. Carbon atoms are sp^3 hybridised.
B. Diamond	II. Used as a dry lubricant
C. Fullerene	III. Used as a reducing agent
D. Graphite	IV. Cage like molecules

Choose the **correct** answer from the options given below :

- (1) A-III, B-I, C-IV, D-II
(2) A-III, B-IV, C-I, D-II
(3) A-II, B-IV, C-I, D-III
(4) A-IV, B-I, C-II, D-III

73 Given below are two statements : one is labelled as **Assertion A** and the other is labelled as **Reason R** :

Assertion A : Metallic sodium dissolves in liquid ammonia giving a deep blue solution, which is paramagnetic.

Reasons R : The deep blue solution is due to the formation of amide.

In the light of the above statements, choose the **correct** answer from the options given below :

- (1) **A** is true but **R** is false.
(2) **A** is false but **R** is true.
(3) Both **A** and **R** are true and **R** is the correct explanation of **A**.
(4) Both **A** and **R** are true but **R** is **NOT** the correct explanation of **A**.

74 Which of the following statements are **NOT** correct?

- A. Hydrogen is used to reduce heavy metal oxides to metals.
B. Heavy water is used to study reaction mechanism.
C. Hydrogen is used to make saturated fats from oils.
D. The H-H bond dissociation enthalpy is lowest as compared to a single bond between two atoms of any element.
E. Hydrogen reduces oxides of metals that are more active than iron.

Choose the **most appropriate** answer from the options given below :

- (1) D, E only
(2) A, B, C only
(3) B, C, D, E only
(4) B, D only

75 The element expected to form largest ion to achieve the nearest noble gas configuration is :

- (1) N (2) Na
(3) O (4) F

76 In Lassaigne's extract of an organic compound, both nitrogen and sulphur are present, which gives blood red colour with Fe^{3+} due to the formation of -

- (1) $[\text{Fe}(\text{CN})_5\text{NOS}]^{4-}$
- (2) $[\text{Fe}(\text{SCN})]^{2+}$
- (3) $\text{Fe}_4[\text{Fe}(\text{CN})_6]_3 \cdot x\text{H}_2\text{O}$
- (4) NaSCN

77 Intermolecular forces are forces of attraction and repulsion between interacting particles that will include :

- A. dipole - dipole forces.
- B. dipole - induced dipole forces.
- C. hydrogen bonding.
- D. covalent bonding.
- E. dispersion forces.

Choose the **most appropriate** answer from the options given below :

- (1) A, B, C, E are correct.
- (2) A, C, D, E are correct.
- (3) B, C, D, E are correct.
- (4) A, B, C, D are correct.

78 Amongst the following, the total number of species NOT having eight electrons around central atom in its outer most shell, is

$\text{NH}_3, \text{AlCl}_3, \text{BeCl}_2, \text{CCl}_4, \text{PCl}_5$:

- (1) 4
- (2) 1
- (3) 3
- (4) 2

79 A compound is formed by two elements A and B. The element B forms cubic close packed structure and atoms of A occupy $\frac{1}{3}$ of tetrahedral voids. If the formula of the compound is A_xB_y , then the value of $x + y$ is in option

- (1) 3
- (2) 2
- (3) 5
- (4) 4

80 Which amongst the following options is **correct** graphical representation of Boyle's Law?

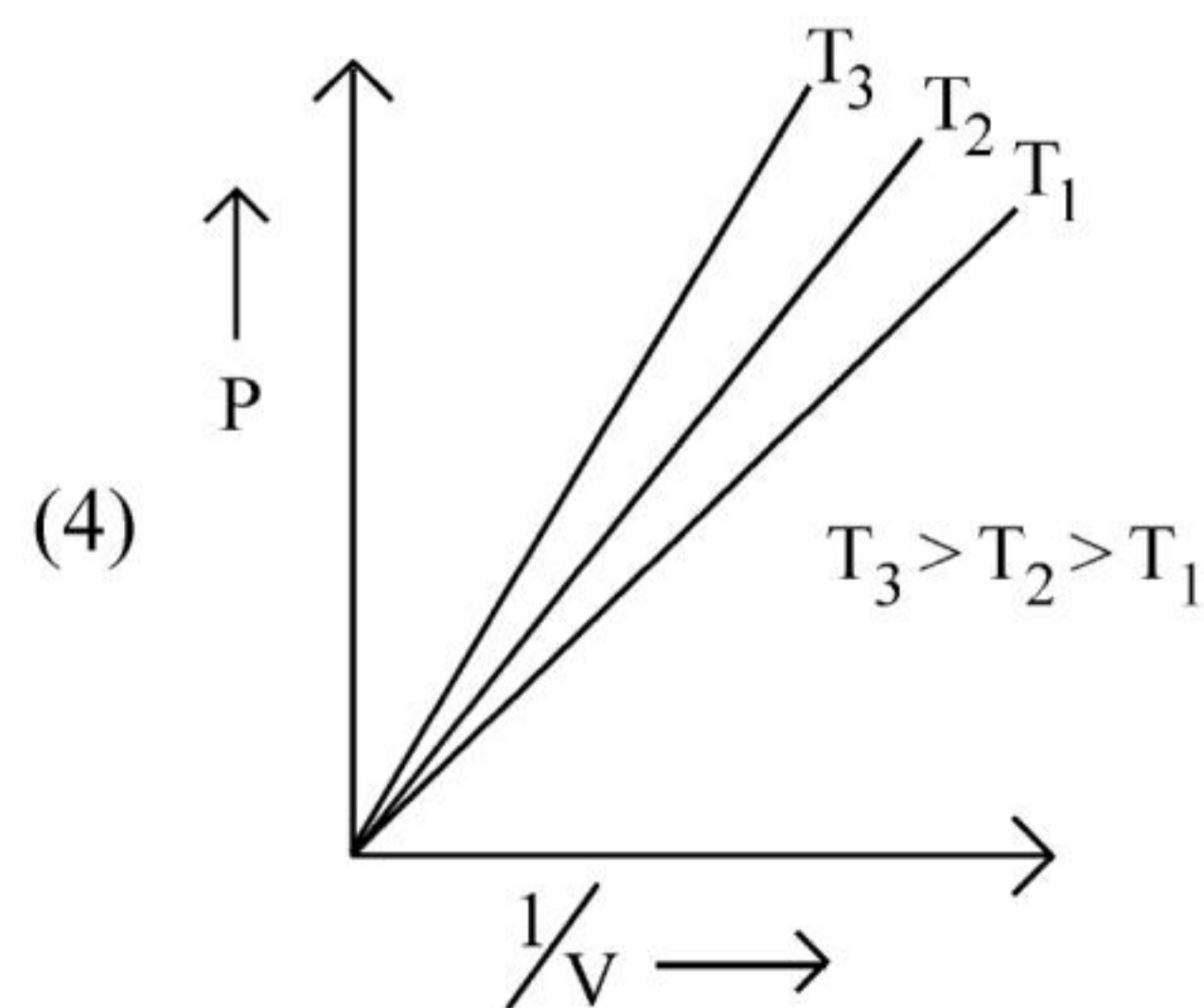
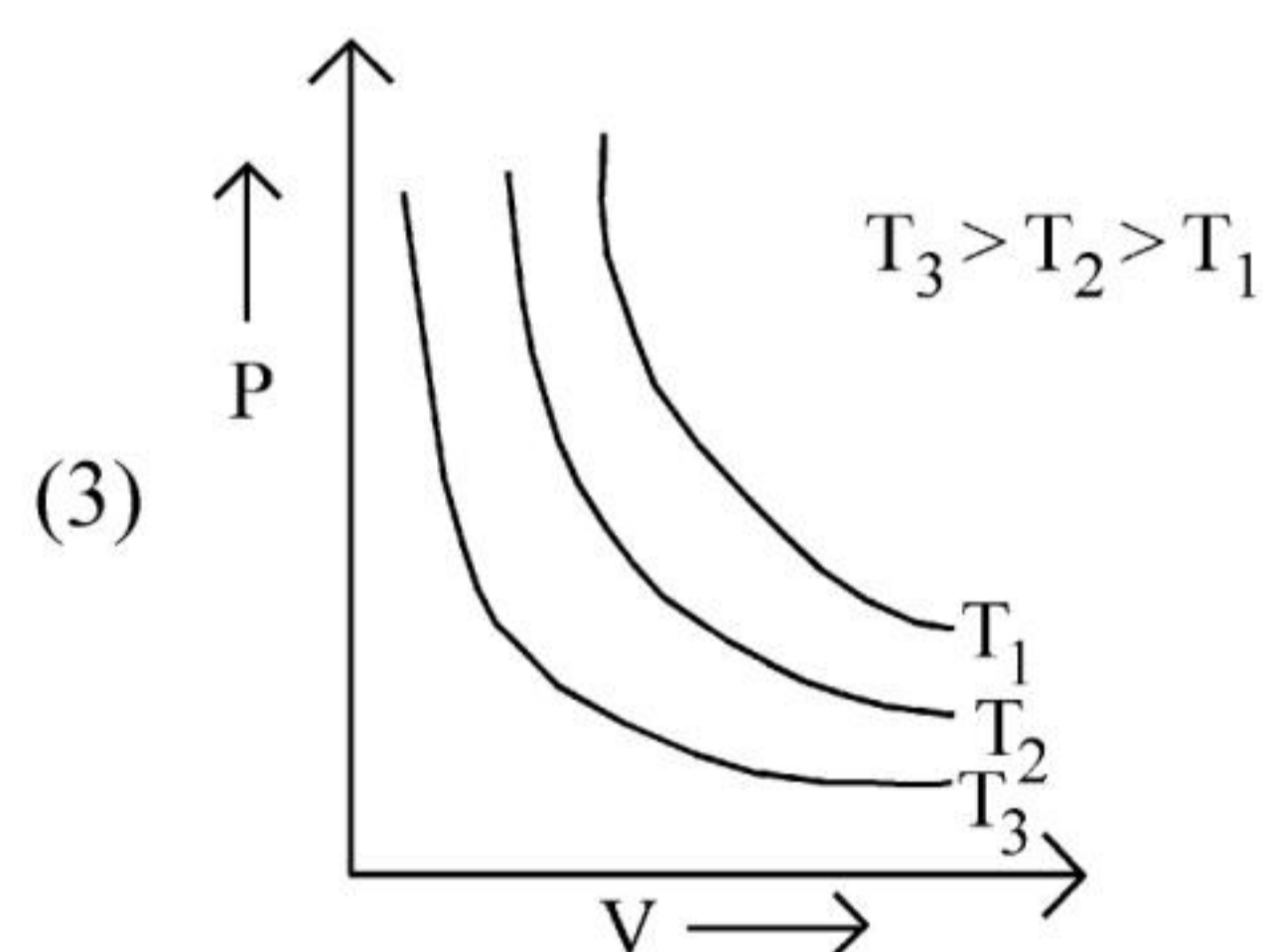
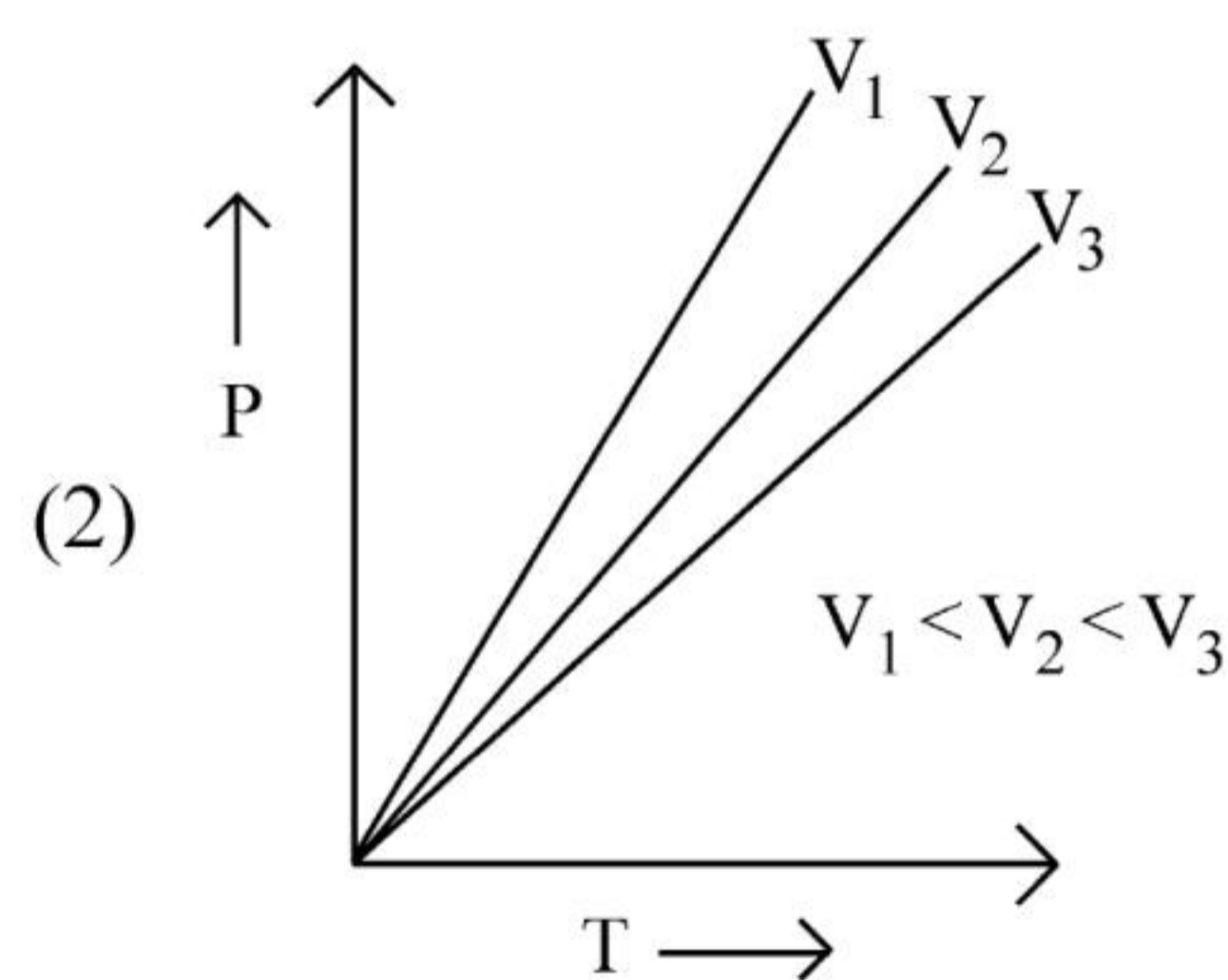
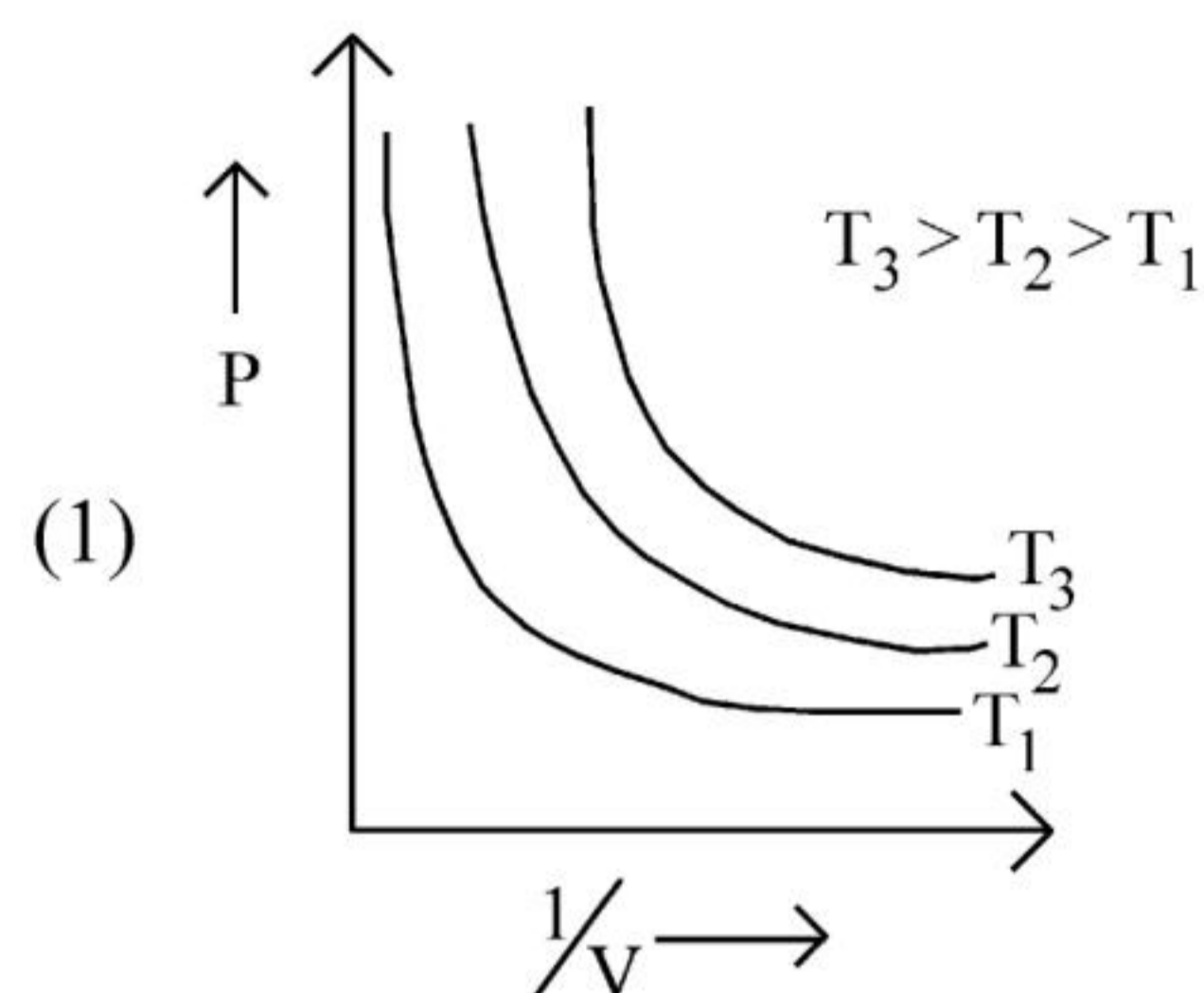

81 Some tranquilizers are listed below. Which one from the following belongs to barbiturates?

- (1) Valium
- (2) Veronal
- (3) Chlordiazepoxide
- (4) Meprobamate

82 Given below are two statements : one is labelled as **Assertion A** and the other is labelled as **Reason R** :

Assertion A : In equation $\Delta_r G = -nFE_{\text{cell}}$, value of $\Delta_r G$ depends on n .

Reasons R : E_{cell} is an intensive property and $\Delta_r G$ is an extensive property.

In the light of the above statements, choose the **correct** answer from the options given below :

- (1) **A** is true but **R** is false.
- (2) **A** is false but **R** is true.
- (3) Both **A** and **R** are true and **R** is the correct explanation of **A**.
- (4) Both **A** and **R** are true and **R** is **NOT** the correct explanation of **A**.

83 Given below are two statements :

Statement I : A unit formed by the attachment of a base to 1' position of sugar is known as nucleoside

Statement II : When nucleoside is linked to phosphorous acid at 5'-position of sugar moiety, we get nucleotide.

In the light of the above statements, choose the **correct** answer from the options given below :

- (1) Statement **I** is true but Statement **II** is false.
- (2) Statement **I** is false but Statement **II** is true.
- (3) Both Statement **I** and Statement **II** are true.
- (4) Both Statement **I** and Statement **II** are false.

84 For a certain reaction, the rate = $k[A]^2[B]$, when the initial concentration of A is tripled keeping concentration of B constant, the initial rate would

- (1) increase by a factor of nine.
- (2) increase by a factor of three.
- (3) decrease by a factor of nine.
- (4) increase by a factor of six.

85 Amongst the given options which of the following molecules / ion acts as a Lewis acid?

- | | |
|-------------------|--------------------------|
| (1) BF_3 | (2) OH^- |
| (3) NH_3 | (4) H_2O |

Chemistry : Section-B (Q. No. 86 to 100)

86 Which of the following statements are **INCORRECT**?

- A. All the transition metals except scandium form MO oxides which are ionic.
- B. The highest oxidation number corresponding to the group number in transition metal oxides is attained in Sc_2O_3 to Mn_2O_7 .
- C. Basic character increases from V_2O_3 to V_2O_4 to V_2O_5 .
- D. V_2O_4 dissolves in acids to give VO_4^{3-} salts.
- E. CrO is basic but Cr_2O_3 is amphoteric. Choose the **correct** answer from the options given below :

- (1) C and D only
 (2) B and C only
 (3) A and E only
 (4) B and D only

87 What fraction of one edge centred octahedral void lies in one unit cell of fcc?

- (1) $\frac{1}{4}$ (2) $\frac{1}{12}$
 (3) $\frac{1}{2}$ (4) $\frac{1}{3}$

88 Match **List - I** with **List - II** :

List - I (Oxoacids of Sulphur) **List - II (Bonds)**

- A. Peroxodisulphuric acid I. Two S-OH, Four S=O, One S-O-S
- B. Sulphuric acid II. Two S-OH, One S=O
- C. Pyrosulphuric acid III. Two S-OH, Four S=O, One S-O-O-S
- D. Sulphurous acid IV. Two S-OH, Two S=O

Choose the **correct** answer from the options given below :

- (1) A-I, B-III, C-IV, D-II
 (2) A-III, B-IV, C-II, D-I
 (3) A-I, B-III, C-II, D-IV
 (4) A-III, B-IV, C-I, D-II

89 Identify the major product obtained in the following reaction :

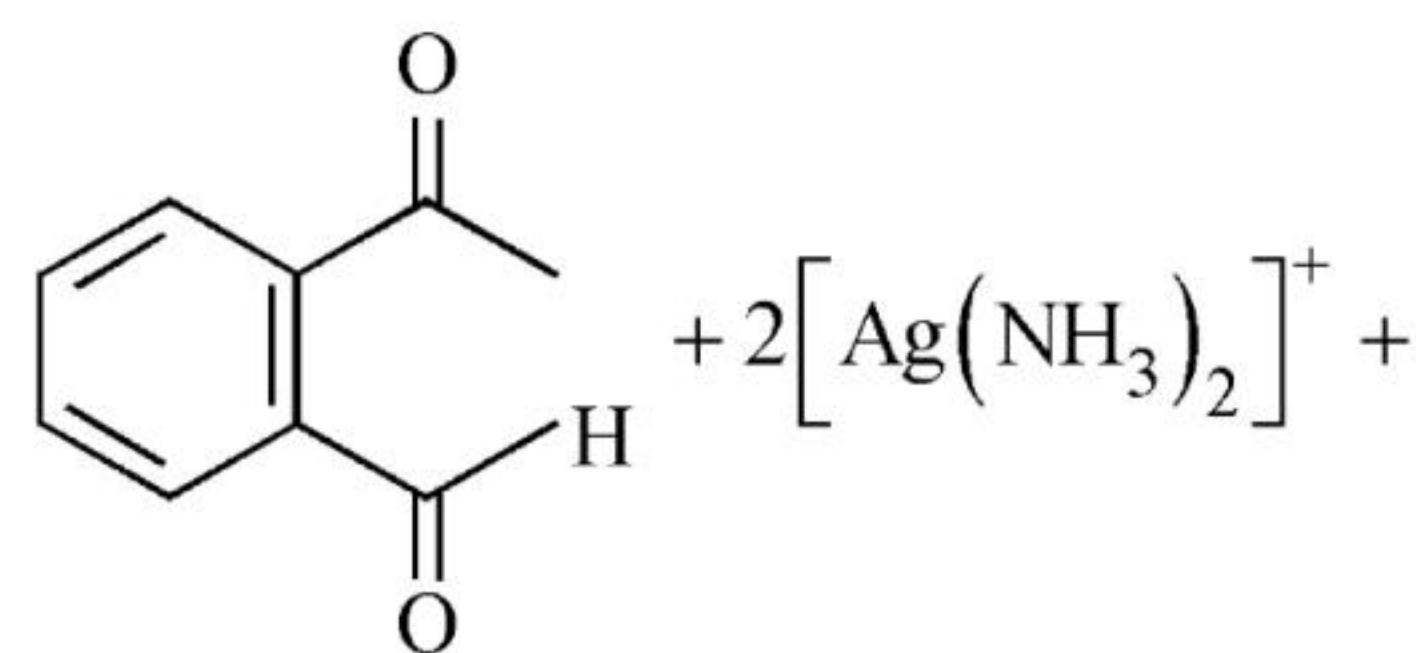

$3^- \text{OH} \xrightarrow{\Delta}$ major product

- (1)
- (2)
- (3)
- (4)

90 Consider the following compounds/species:

- i.
- ii.
- iii.
- iv.
- v.
- vi.
- vii.

The number of compounds/species which obey Huckel's rule is _____.

- (1) 2 (2) 5
 (3) 4 (4) 6

91 Which amongst the following options is the **correct** relation between change in enthalpy and change in internal energy?

- (1) $\Delta H - \Delta U = -\Delta nRT$
- (2) $\Delta H + \Delta U = \Delta nR$
- (3) $\Delta H = \Delta U - \Delta n_g RT$
- (4) $\Delta H = \Delta U + \Delta n_g RT$

92 Given below are two statements :

Statement I : The nutrient deficient water bodies lead to eutrophication.

Statement II : Eutrophication leads to decrease in the level of oxygen in the water bodies.

In the light of the above statements, choose the **correct** answer from the options given below :

- (1) **Statement I** is correct but **Statement II** is false.
- (2) **Statement I** is incorrect but **Statement II** is true.
- (3) Both **Statement I** and **Statement II** are true.
- (4) Both **Statement I** and **Statement II** are false.

93 Pumice stone is an example of -

- (1) solid sol (2) foam
- (3) sol (4) gel

94 Which complex compound is most stable?

- (1) $[\text{CoCl}_2(\text{en})_2]\text{NO}_3$
- (2) $[\text{Co}(\text{NH}_3)_6]_2(\text{SO}_4)_3$
- (3) $[\text{Co}(\text{NH}_3)_4(\text{H}_2\text{O})\text{Br}](\text{NO}_3)_2$
- (4) $[\text{Co}(\text{NH}_3)_3(\text{NO}_3)_3]$

95 The reaction that does **NOT** take place in a blast furnace between 900 K to 1500 K temperature range during extraction of iron is :

- (1) $\text{C} + \text{CO}_2 \rightarrow 2\text{CO}$
- (2) $\text{CaO} + \text{SiO}_2 \rightarrow \text{CaSiO}_3$
- (3) $\text{Fe}_2\text{O}_3 + \text{CO} \rightarrow 2\text{FeO} + \text{CO}_2$
- (4) $\text{FeO} + \text{CO} \rightarrow \text{Fe} + \text{CO}_2$

96 The equilibrium concentrations of the species in the reaction $\text{A} + \text{B} \rightleftharpoons \text{C} + \text{D}$ are 2, 3, 10 and 6 mol L⁻¹, respectively at 300 K. ΔG° for the reaction is (R = 2 cal / mol K)

- (1) -1381.80 cal
- (2) -13.73 cal
- (3) 1372.60 cal
- (4) -137.26 cal

97 Consider the following reaction :

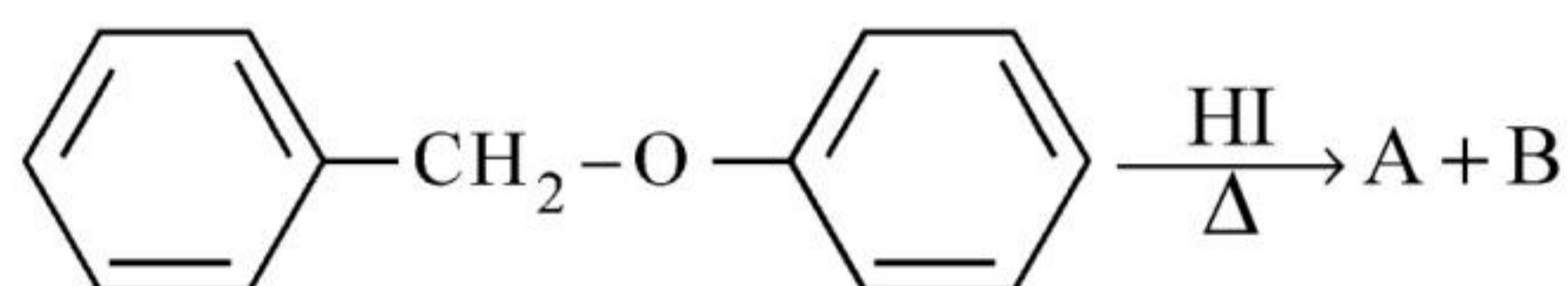

Identify products A and B.

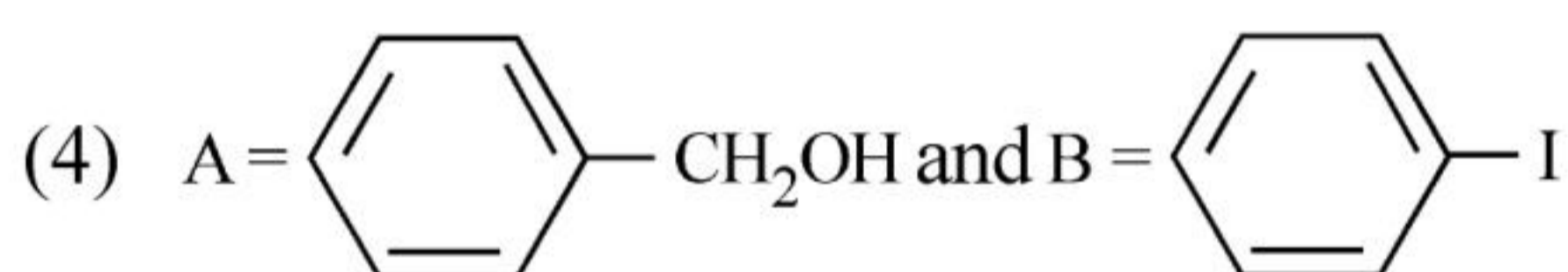
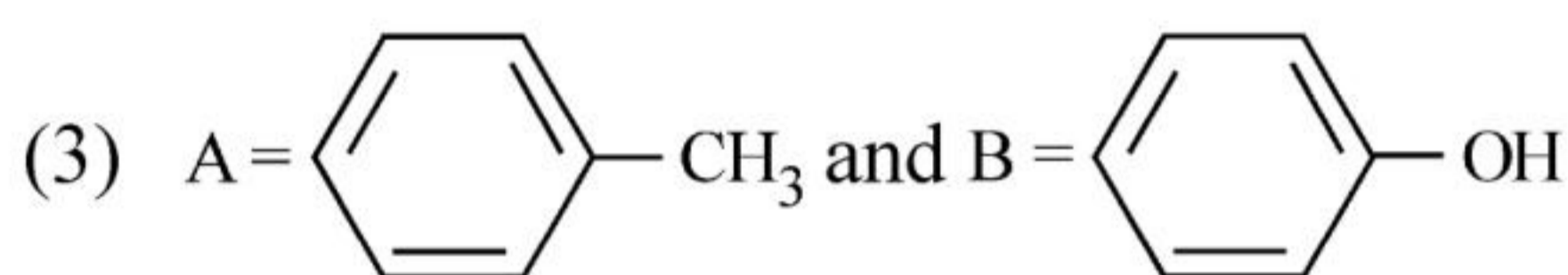
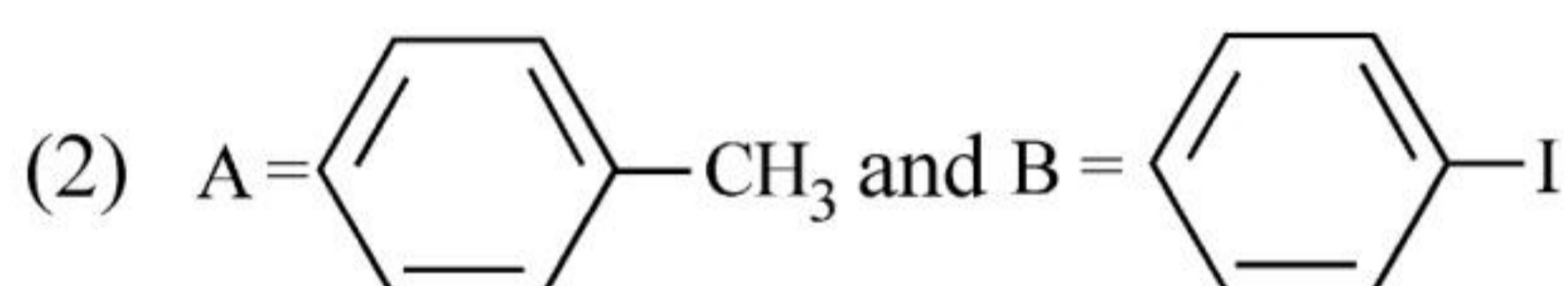
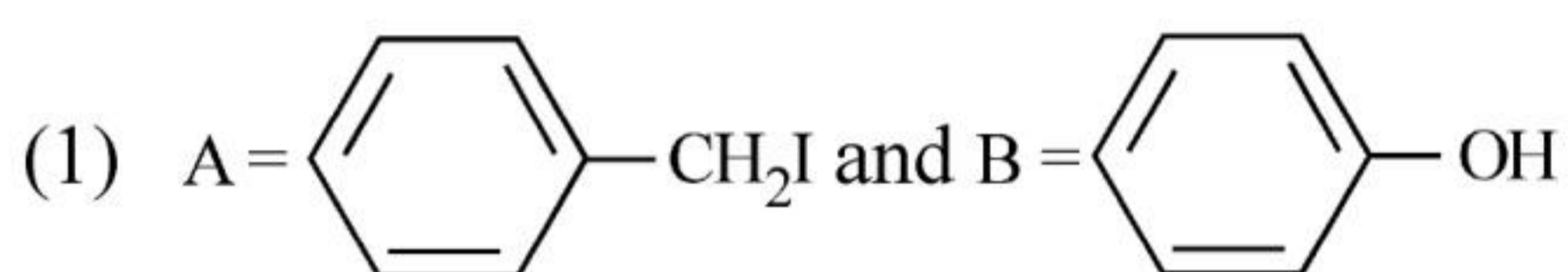

98 Which amongst the following will be most readily dehydrated under acidic conditions ?

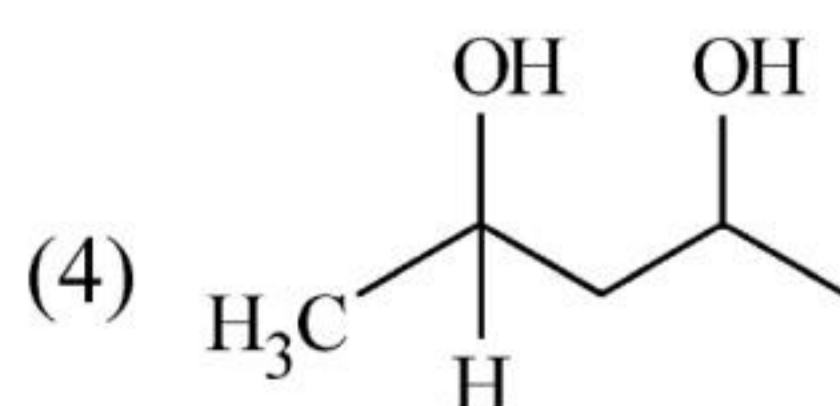
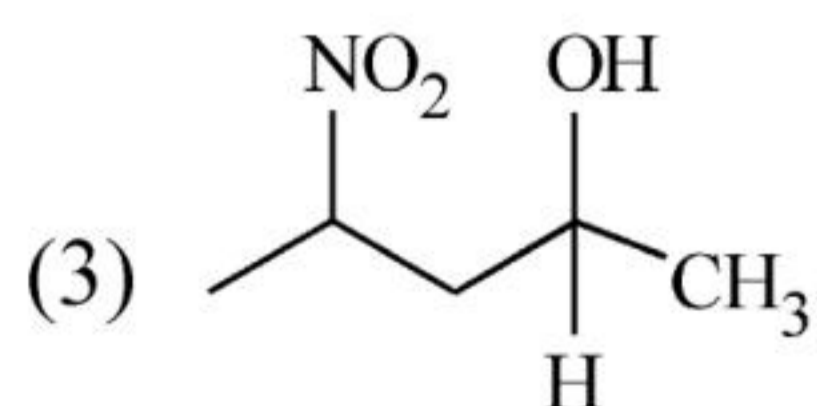
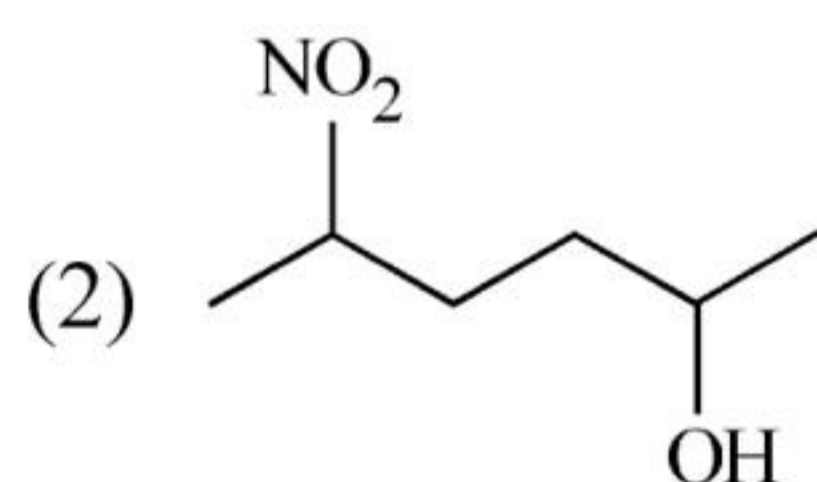
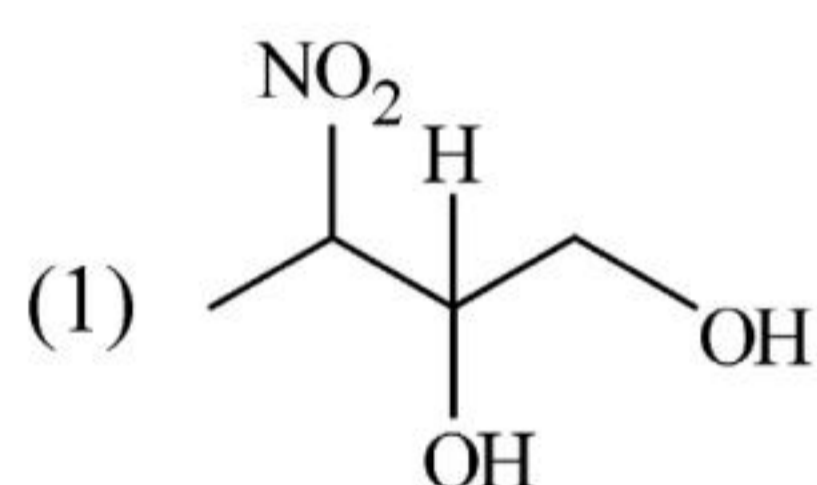

99 Identify the final product [D] obtained in the following sequence of reactions.

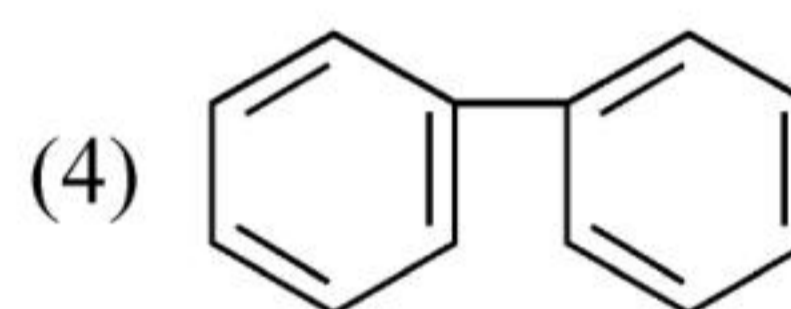
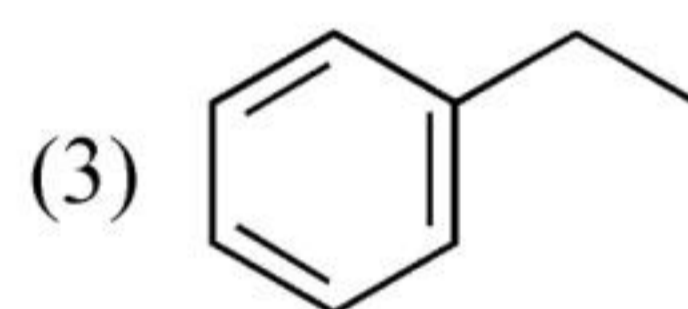
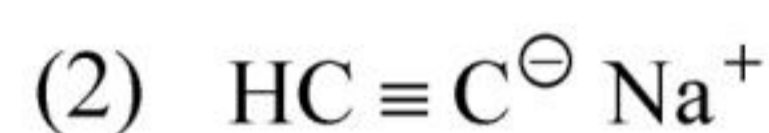
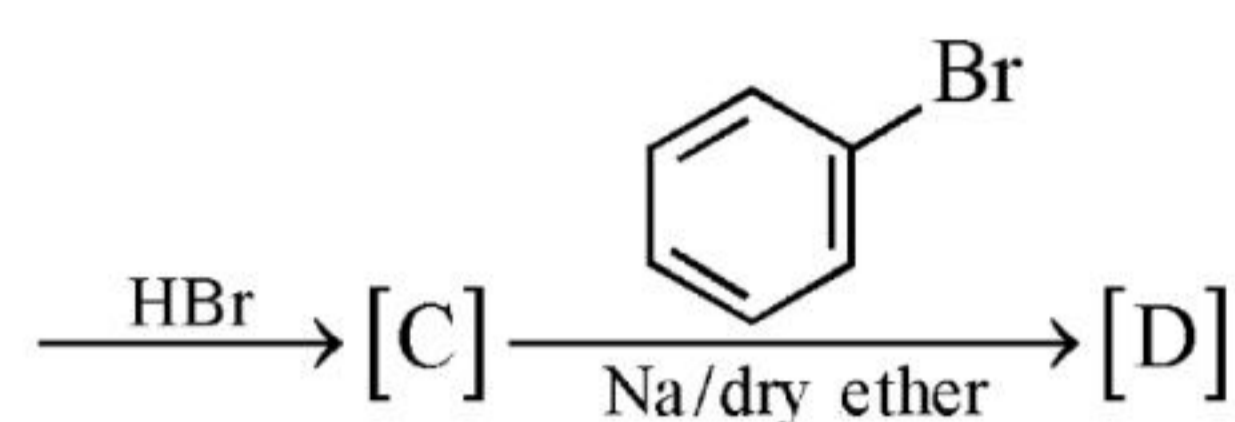
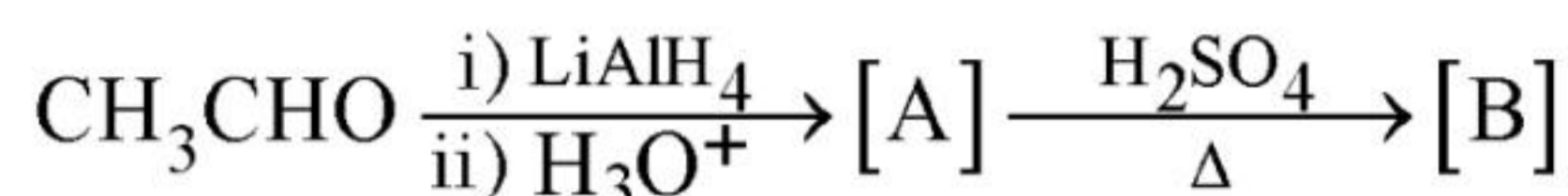

100 On balancing the given redox reaction,

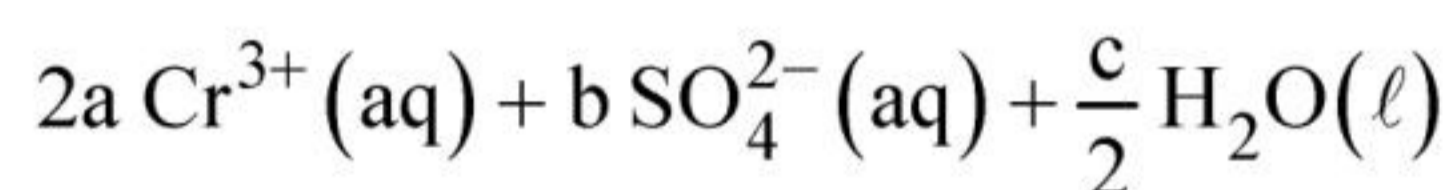
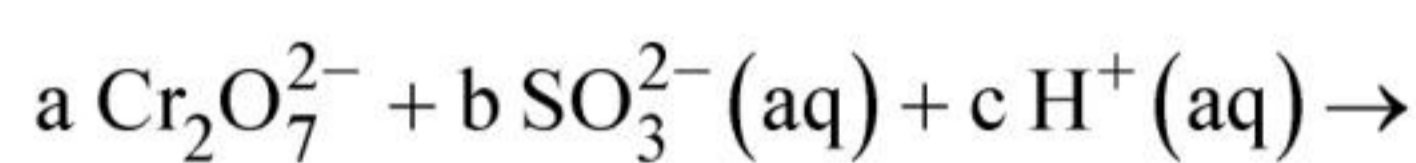

the coefficients a, b and c are found to be, respectively -



Botany : Section-A (Q. No. 101 to 135)

- 101** Given below are two statements : One is labelled as **Assertion A** and the other is labelled as **Reason R** :
Assertion A : Late wood has fewer xylary elements with narrow vessels.
Reason R : Cambium is less active in winters.
In the light of the above statements, choose the **correct** answer from the options given below :
- (1) **A** is true but **R** is false.
 - (2) **A** is false but **R** is true.
 - (3) Both **A** and **R** are true and **R** is the correct explanation of **A**.
 - (4) Both **A** and **R** are true but **R** is NOT the correct explanation of **A**.
- 102** The historic Convention on Biological Diversity, 'The Earth Summit' was held in Rio de Janeiro in the year :
- (1) 1986
 - (2) 2002
 - (3) 1985
 - (4) 1992
- 103** In the equation
- $$\boxed{GPP - R = NPP}$$
- GPP is Gross Primary Productivity
NPP is Net Primary Productivity
R here is _____.
- (1) Respiratory loss
 - (2) Reproductive allocation
 - (3) Photosynthetically active radiation
 - (4) Respiratory quotient
- 104** What is the function of tassels in the corn cob?
- (1) To disperse pollen grains
 - (2) To protect seeds
 - (3) To attract insects
 - (4) To trap pollen grains
- 105** What is the role of RNA polymerase III in the process of transcription in Eukaryotes?
- (1) Transcription of precursor of mRNA
 - (2) Transcription of only snRNAs
 - (3) Transcription of rRNAs (28S, 18S and 5.8S)
 - (4) Transcription of tRNA, 5 srRNA and snRNA
- 106** Upon exposure to UV radiation, DNA stained with ethidium bromide will show
- (1) Bright yellow colour
 - (2) Bright orange colour
 - (3) Bright red colour
 - (4) Bright blue colour
- 107** The thickness of ozone in a column of air in the atmosphere is measured in terms of :
- (1) Decameter
 - (2) Kilobase
 - (3) Dobson units
 - (4) Decibels
- 108** The phenomenon of pleiotropism refers to
- (1) a single gene affecting multiple phenotypic expression.
 - (2) more than two genes affecting a single character.
 - (3) presence of several alleles of a single gene controlling a single crossover.
 - (4) presence of two alleles, each of the two genes controlling a single trait.
- 109** Spraying of which of the following phytohormone on juvenile conifers helps in hastening the maturity period, that leads to early seed production?
- (1) Zeatin
 - (2) Abscisic Acid
 - (3) Indole-3-butyric Acid
 - (4) Gibberellic Acid
- 110** Given below are two statements : One is labelled as **Assertion A** and the other is labelled as **Reason R** :
Assertion A : The first stage of gametophyte in the life cycle of moss is protonema stage.
Reason R : Protonema develops directly from spores produced in capsule.
In the light of the above statements, choose the **most appropriate** answer from the options given below :
- (1) **A** is correct but **R** is not correct.
 - (2) **A** is not correct but **R** is correct.
 - (3) Both **A** and **R** are correct and **R** is the correct explanation of **A**.
 - (4) Both **A** and **R** are correct but **R** is NOT the correct explanation of **A**.

- 111** During the purification process for recombinant DNA technology, addition of chilled ethanol precipitates out
 (1) Histones (2) Polysaccharides
 (3) RNA (4) DNA
- 112** The reaction centre in PS II has an absorption maxima at
 (1) 660 nm (2) 780 nm
 (3) 680 nm (4) 700 nm
- 113** Family Fabaceae differs from Solanaceae and Liliaceae. With respect to the stamens, pick out the characteristics specific to family Fabaceae but not found in Solanaceae or Liliaceae.
 (1) Monoadelphous and Monothealous anthers
 (2) Epiphyllous and Dithealous anthers
 (3) Diadelphous and Dithealous anthers
 (4) Polyadelphous and epipetalous stamens
- 114** Which micronutrient is required for splitting of water molecule during photosynthesis?
 (1) magnesium (2) copper
 (3) manganese (4) molybdenum
- 115** Among 'The Evil Quartet', which one is considered the most important cause driving extinction of species?
 (1) Alien species invasions
 (2) Co-extinctions
 (3) Habitat loss and fragmentation
 (4) Over exploitation for economic gain
- 116** Movement and accumulation of ions across a membrane against their concentration gradient can be explained by
 (1) Passive Transport
 (2) Active Transport
 (3) Osmosis
 (4) Facilitated Diffusion
- 117** In tissue culture experiments, leaf mesophyll cells are put in a culture medium to form callus. This phenomenon may be called as -
 (1) Development
 (2) Senescence
 (3) Differentiation
 (4) Dedifferentiation
- 118** The process of appearance of recombination nodules occurs at which sub stage of prophase I in meiosis?
 (1) Diplotene (2) Diakinesis
 (3) Zygotene (4) Pachytene
- 119** Given below are two statements :
Statement I : The forces generated by transpiration can lift a xylem-sized column of water over 130 meters height.
Statement II : Transpiration cools leaf surfaces sometimes 10 to 15 degrees, by evaporative cooling.
 In the light of the above statements, choose the **most appropriate** answer from the options given below :
 (1) **Statement I** is correct but **Statement II** is incorrect.
 (2) **Statement I** is incorrect but **Statement II** is correct.
 (3) Both **Statement I** and **Statement II** are correct.
 (4) Both **Statement I** and **Statement II** are incorrect.
- 120** Axile placentation is observed in
 (1) Tomato, Dianthus and Pea
 (2) China rose, Petunia and Lemon
 (3) Mustard, Cucumber and Primrose
 (4) China rose, Beans and Lupin
- 121** Which of the following stages of meiosis involves division of centromere?
 (1) Anaphase II (2) Telophase
 (3) Metaphase I (4) Metaphase II
- 122** Frequency of recombination between gene pairs on same chromosome as a measure of the distance between genes to map their position on chromosome, was used for the first time by
 (1) Alfred Sturtevant
 (2) Hanking
 (3) Thomas Hunt Morgan
 (4) Sutton and Boveri

- 123** Cellulose does not form blue colour with Iodine because
- (1) It does not contain complex helices and hence cannot hold iodine molecules.
 - (2) It breaks down when iodine reacts with it.
 - (3) It is a disaccharide.
 - (4) It is a helical molecule.
- 124** In gene gun method used to introduce alien DNA into host cells, microparticles of _____ metal are used.
- (1) Tungsten or gold
 - (2) Silver
 - (3) Copper
 - (4) Zinc
- 125** Identify the pair of heterosporous pteridophytes among the following :
- (1) *Psilotum* and *Salvinia*
 - (2) *Equisetum* and *Salvinia*
 - (3) *Lycopodium* and *Selaginella*
 - (4) *Selaginella* and *Salvinia*
- 126** Unequivocal proof that DNA is the genetic material was first proposed by
- (1) Avery, Macleoid and McCarthy
 - (2) Wilkins and Franklin
 - (3) Frederick Griffith
 - (4) Alfred Hershey and Martha Chase
- 127** How many ATP and NADPH₂ are required for the synthesis of one molecule of Glucose during Calvin cycle?
- (1) 12 ATP and 16 NADPH₂
 - (2) 18 ATP and 16 NADPH₂
 - (3) 12 ATP and 12 NADPH₂
 - (4) 18 ATP and 12 NADPH₂
- 128** Identify the **correct** statements :
- A. Detrivores perform fragmentation.
 - B. The humus is further degraded by some microbes during mineralization.
 - C. Water soluble inorganic nutrients go down into the soil and get precipitated by a process called leaching.
 - D. The detritus food chain begins with living organisms.
 - E. Earthworms break down detritus into smaller particles by a process called catabolism.
- Choose the **correct** answer from the options given below :
- (1) C, D, E only
 - (2) D, E, A only
 - (3) A, B, C only
 - (4) B, C, D only
- 129** In angiosperm, the haploid, diploid and triploid structures of a fertilized embryo sac sequentially are :
- (1) Synergids, Zygote and Primary endosperm nucleus
 - (2) Synergids, antipodals and Polar nuclei
 - (3) Synergids, Primary endosperm nucleus and zygote
 - (4) Antipodals, synergids, and primary endosperm nucleus
- 130** Given below are two statements : One is labelled as **Assertion A** and the other is labelled as **Reason R** :
- Assertion A** : ATP is used at two steps in glycolysis.
- Reason R** : First ATP is used in converting glucose into glucose-6-phosphate and second ATP is used in conversion of fructose-6-phosphate into fructose-1-6-diphosphate.
- In the light of the above statements, choose the **correct** answer from the options given below :
- (1) **A** is true but **R** is false.
 - (2) **A** is false but **R** is true.
 - (3) Both **A** and **R** are true and **R** is the correct explanation of **A**.
 - (4) Both **A** and **R** are true but **R** is NOT the correct explanation of **A**.

- 131** Expressed Sequence Tags (ESTs) refers to
- (1) All genes whether expressed or unexpressed.
 - (2) Certain important expressed genes.
 - (3) All genes that are expressed as RNA.
 - (4) All genes that are expressed as proteins.

- 132** Among eukaryotes, replication of DNA takes place in -
- (1) G₁ phase (2) G₂ phase
 - (3) M phase (4) S phase

- 133** Given below are two statements :
- Statement I** : Endarch and exarch are the terms often used for describing the position of secondary xylem in the plant body.

Statement II : Exarch condition is the most common feature of the root system.

In the light of the above statements, choose the **correct** answer from the options given below :

- (1) **Statement I** is correct but **Statement II** is false.
- (2) **Statement I** is incorrect but **Statement II** is true.
- (3) Both **Statement I** and **Statement II** are true.
- (4) Both **Statement I** and **Statement II** are false.

- 134** Large, colourful, fragrant flowers with nectar are seen in :
- (1) bat pollinated plants
 - (2) wind pollinated plants
 - (3) insect pollinated plants
 - (4) bird pollinated plants

- 135** Which hormone promotes internode/petiole elongation in deep water rice?
- (1) Ethylene (2) 2, 4-D
 - (3) GA₃ (4) Kinetin

- 136** Given below are two statements : One is labelled as **Assertion A** and the other is labelled as **Reason R** :

Assertion A : A flower is defined as modified shoot wherein the shoot apical meristem changes to floral meristem.

Reason R : Internode of the shoot gets condensed to produce different floral appendages laterally at successive nodes instead of leaves.

In the light of the above statements, choose the **correct** answer from the options given below :

- (1) **A** is true but **R** is false.
- (2) **A** is false but **R** is true.
- (3) Both **A** and **R** are true and **R** is the correct explanation of **A**.
- (4) Both **A** and **R** are true but **R** is NOT the correct explanation of **A**.

- 137** Match **List I** with **List II** :

List I	List II
A. M Phase	I. Proteins are synthesized
B. G ₂ Phase	II. Inactive phase
C. Quiescent stage	III. Interval between mitosis and initiation of DNA replication
D. G ₁ Phase	IV. Equational division

Choose the correct answer from the options given below :

- (1) A-IV, B-I, C-II, D-III
- (2) A-II, B-IV, C-I, D-III
- (3) A-III, B-II, C-IV, D-I
- (4) A-IV, B-II, C-I, D-III

- 138** How many different proteins does the ribosome consist of?
- (1) 40 (2) 20
 - (3) 80 (4) 60

139 Which one of the following statements is **NOT** correct?

- (1) Water hyacinth grows abundantly in eutrophic water bodies and leads to an imbalance in the ecosystem dynamics of the water body.
- (2) The amount of some toxic substances of industrial waste water increases in the organisms at successive trophic levels.
- (3) The micro-organisms involved in biodegradation of organic matter in a sewage polluted water body consume a lot of oxygen causing the death of aquatic organisms.
- (4) Algal blooms caused by excess of organic matter in water improve water quality and promote fisheries.

140 Which of the following combinations is required for chemiosmosis?

- (1) proton pump, electron gradient, ATP synthase
- (2) proton pump, electron gradient, NADP synthase
- (3) membrane, proton pump, proton gradient, ATP synthase
- (4) membrane, proton pump, proton gradient, NADP synthase

141 Match **List I** with **List II** :

List I	List II
A. Cohesion	I. More attraction in liquid phase
B. Adhesion	II. Mutual attraction among water molecules
C. Surface tension	III. Water loss in liquid phase
D. Guttation	IV. Attraction towards polar surfaces

Choose the **correct** answer from the options given below :

- (1) A-III, B-I, C-IV, D-II
- (2) A-II, B-I, C-IV, D-III
- (3) A-II, B-IV, C-I, D-III
- (4) A-IV, B-III, C-II, D-I

142 Match **List I** with **List II** :

List I	List II
A. Iron	I. Synthesis of auxin
B. Zinc	II. Component of nitrate reductase
C. Boron	III. Activator of catalase
D. Molybdenum	IV. Cell elongation and differentiation

Choose the correct answer from the options given below :

- (1) A-III, B-I, C-IV, D-II
- (2) A-II, B-IV, C-I, D-III
- (3) A-III, B-II, C-I, D-IV
- (4) A-II, B-III, C-IV, D-I

143 Given below are two statements :

Statement I : Gause's 'Competitive Exclusion Principle' states that two closely related species competing for the same resources cannot co-exist indefinitely and competitively inferior one will be eliminated eventually.

Statement II : In general, carnivores are more adversely affected by competition than herbivores.

In the light of the above statements, choose the **correct** answer from the options given below :

- (1) **Statement I** is correct but **Statement II** is false.
- (2) **Statement I** is incorrect but **Statement II** is true.
- (3) Both **Statement I** and **Statement II** are true.
- (4) Both **Statement I** and **Statement II** are false.

144 Melonate inhibits the growth of pathogenic bacteria by inhibiting the activity of

- (1) Lipase
- (2) Dinitrogenase
- (3) Succinic dehydrogenase
- (4) Amylase

- 145** Identify the **correct** statements :
- Lenticels are the lens-shaped openings permitting the exchange of gases.
 - Bark formed early in the season is called hard bark.
 - Bark is a technical term that refers to all tissues exterior to vascular cambium.
 - Bark refers to periderm and secondary phloem.
 - Phellogen is single-layered in thickness.
- Choose the correct answer from the options given below :
- A, B and D only
 - B and C only
 - B, C and E only
 - A and D only
- 146** Given below are two statements : One is labelled as **Assertion A** and the other is labelled as **Reason R** :
- Assertion A** : In gymnosperms the pollen grains are released from the microsporangium and carried by air currents.
- Reason R** : Air currents carry the pollen grains to the mouth of the archegonia where the male gametes are discharged and pollen tube is not formed.
- In the light of the above statements, choose the **correct** answer from the options given below :
- A is true but R is false.
 - A is false but R is true.
 - Both A and R are true and R is the correct explanation of A.
 - Both A and R are true but R is NOT the correct explanation of A.
- 147** Which of the following statements are correct about Klinefelter's Syndrome?
- This disorder was first described by Langdon Down (1866).
 - Such an individual has overall masculine development. However, the feminine development is also expressed.
 - The affected individual is short statured.
 - Physical, psychomotor and mental development is retarded.
 - Such individuals are sterile.
- Choose the **correct** answer from the options given below :
- B and E only
 - A and E only
 - A and B only
 - C and D only

- 148** Main steps in the formation of Recombinant DNA are given below. Arrange these steps in a correct sequence.
- Insertion of recombinant DNA into the host cell.
 - Cutting of DNA at specific location by restriction enzyme.
 - Isolation of desired DNA fragment.
 - Amplification of gene of interest using PCR.
- Choose the correct answer from the options given below :
- C, B, D, A
 - B, D, A, C
 - B, C, D, A
 - C, A, B, D
- 149** Match **List I** with **List II** :
- | List I | List II |
|------------------------------|--------------------------------|
| A. Oxidative decarboxylation | I. Citrate synthase |
| B. Glycolysis | II. Pyruvate dehydrogenase |
| C. Oxidative phosphorylation | III. Electron transport system |
| D. Tricarboxylic acid cycle | IV. EMP pathway |
- Choose the correct answer from the options given below :
- A-III, B-I, C-II, D-IV
 - A-II, B-IV, C-III, D-I
 - A-III, B-IV, C-II, D-I
 - A-II, B-IV, C-I, D-III
- 150** Match **List I** with **List II** :
- | List I | List II |
|----------------------|--------------------------|
| (Interaction) | (Species A and B) |
| A. Mutualism | I. +(A), O(B) |
| B. Commensalism | II. -(A), O(B) |
| C. Amensalism | III. +(A), -(B) |
| D. Parasitism | IV. +(A), +(B) |
- Choose the **correct** answer from the options given below :
- A-IV, B-III, C-I, D-II
 - A-III, B-I, C-IV, D-II
 - A-IV, B-II, C-I, D-III
 - A-IV, B-I, C-II, D-III

Zoology : Section-A (Q. No. 151 to 185)

- 151** Broad palm with single palm crease is visible in a person suffering from-
- (1) Klinefelter's syndrome
 - (2) Thalassemia
 - (3) Down's syndrome
 - (4) Turner's syndrome

- 152** Given below are two statements:
Statement I: A protein is imagined as a line, the left end represented by first amino acid (C-terminal) and the right end represented by last amino acid (N-terminal)

Statement II: Adult human haemoglobin, consists of 4 subunits (two subunits of α type and two subunits of β type.)

In the light of the above statements, choose the **correct** answer from the options given below:

- (1) **Statement I** is true but **Statement II** is false.
- (2) **Statement I** is false but **Statement II** is true.
- (3) Both **Statement I** and **Statement II** are true.
- (4) Both **Statement I** and **Statement II** are false.

- 153** Given below are statements: one is labelled as **Assertion A** and the other is labelled as **Reason R**.

Assertion A: Nephrons are of two types: Cortical & Juxta medullary, based on their relative position in cortex and medulla.

Reason R: Juxta medullary nephrons have short loop of Henle whereas, cortical nephrons have longer loop of Henle.

In the light of the above statements, choose the **correct** answer from the options given below:

- (1) **A** is true but **R** is false.
- (2) **A** is false but **R** is true.
- (3) Both **A** and **R** are true and **R** is the correct explanation of **A**.
- (4) Both **A** and **R** are true but **R** is NOT the correct explanation of **A**.

- 154** Match **List I** with **List II**.

List I	List II
A. Heroin	I. Effect on cardiovascular system
B. Marijuana	II. Slow down body function
C. Cocaine	III. Painkiller
D. Morphine	IV. Interfere with transport of dopamine

Choose the **correct** answer from the options given below:

- (1) A-IV, B-III, C-II, D-I
- (2) A-III, B-IV, C-I, D-II
- (3) A-II, B-I, C-IV, D-III
- (4) A-I, B-II, C-III, D-IV

- 155** Vital capacity of lung is _____.

- (1) IRV + ERV + TV - RV
- (2) IRV + ERV + TV
- (3) IRV + ERV
- (4) IRV + ERV + TV + RV

- 156** Match **List I** with **List II**.

List I	List II
A. P - wave	I. Beginning of systole
B. Q - wave	II. Repolarisation of ventricles
C. QRS complex	III. Depolarisation of atria
D. T - wave	IV. Depolarisation of ventricles

Choose the **correct** answer from the options given below:

- (1) A-II, B-IV, C-I, D-III
- (2) A-I, B-II, C-III, D-IV
- (3) A-III, B-I, C-IV, D-II
- (4) A-IV, B-III, C-II, D-I

157 Match List I with List II.

List I (Cells)	List II (Secretion)
A. Peptic cells	I. Mucus
B. Goblet cells	II. Bile juice
C. Oxyntic cells	III. Proenzyme pepsinogen
D. Hepatic cells	IV. HCl and intrinsic factor for absorption of vitamin B ₁₂

Choose the **correct** answer from the options given below:

- (1) A-III, B-I, C-IV, D-II
- (2) A-II, B-IV, C-I, D-III
- (3) A-IV, B-III, C-II, D-I
- (4) A-II, B-I, C-III, D-IV

158 Match List I with List II.

List I	List II
A. Vasectomy	I. Oral method
B. Coitus interruptus	II. Barrier method
C. Cervical caps	III. Surgical method
D. Saheli	IV. Natural method

Choose the **correct** answer from the options given below:

- (1) A-II, B-III, C-I, D-IV
- (2) A-IV, B-II, C-I, D-III
- (3) A-III, B-I, C-IV, D-II
- (4) A-III, B-IV, C-II, D-I

159 Which one of the following common sexually transmitted diseases is completely curable when detected early and treated properly?

- (1) Hepatitis-B
- (2) HIV Infection
- (3) Genital herpes
- (4) Gonorrhoea

160 Match List I with List II.

List I	List II
A. Ringworm	I. <i>Haemophilus influenzae</i>
B. Filariasis	II. <i>Trichophyton</i>
C. Malaria	III. <i>Wuchereria bancrofti</i>
D. Pneumonia	IV. <i>Plasmodium vivax</i>

Choose the **correct** answer from the options given below:

- (1) A-III, B-II, C-I, D-IV
- (2) A-III, B-II, C-IV, D-I
- (3) A-II, B-III, C-IV, D-I
- (4) A-II, B-III, C-I, D-IV

161 Which of the following are NOT considered as the part of endomembrane system?

- | | |
|-----------------|--------------------------|
| A. Mitochondria | B. Endoplasmic Reticulum |
| C. Chloroplasts | D. Golgi complex |
| E. Peroxisomes | |

Choose the **most appropriate** answer from the options given below:

- (1) A and D only
- (2) A, D and E only
- (3) B and D only
- (4) A, C and E only

162 Which of the following is not a cloning vector?

- | | |
|------------|-----------|
| (1) pBR322 | (2) Probe |
| (3) BAC | (4) YAC |



163 Match List I with List II.

List I (Interacting species)	List II (Name of Interaction)
A. A Leopard and a Lion in a forest/ grassland	I. Competition
B. A Cuckoo laying egg in a Crow's nest	II. Brood parasitism
C. Fungi and root of a higher plant in Mycorrhizae	III. Mutualism
D. A cattle egret and a Cattle in a field	IV. Commensalism

Choose the **correct** answer from the options given below:

- (1) A-III, B-IV, C-I, D-II
- (2) A-II, B-III, C-I, D-IV
- (3) A-I, B-II, C-III, D-IV
- (4) A-I, B-II, C-IV, D-III

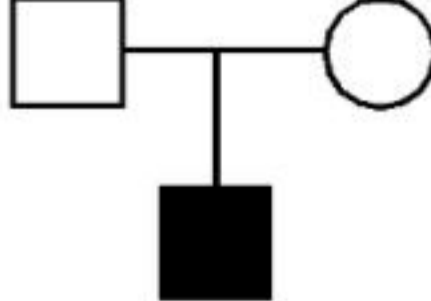
164 Which one of the following symbols represents mating between relatives in human pedigree analysis?

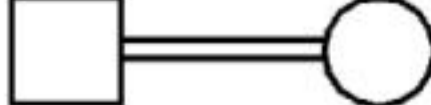
- | | |
|---|---|
| (1)  | (2)  |
| (3)  | (4)  |

165 Match List I with List II.

List I	List II
A. <i>Taenia</i>	I. Nephridia
B. <i>Paramoecium</i>	II. Contractile vacuole
C. <i>Periplaneta</i>	III. Flame cells
D. <i>Pheretima</i>	IV. Urecose gland

Choose the **correct** answer from the options give below:

- (1) A-III, B-II, C-IV, D-I
- (2) A-II, B-I, C-IV, D-III
- (3) A-I, B-II, C-III, D-IV
- (4) A-I, B-II, C-IV, D-III

166 Once the undigested and unabsorbed substances enter the caecum, their backflow is prevented by-

- (1) Gastro - oesophageal sphincter
- (2) Pyloric sphincter
- (3) Sphincter of Oddi
- (4) Ileo - caecal valve

167 Match List I with List II.

List I	List II
A. Gene 'a'	I. β -galactosidase
B. Gene 'y'	II. Transacetylase
C. Gene 'i'	III. Permease
D. Gene 'z'	IV. Repressor protein

Choose the **correct** answer from the options given below:

- (1) A-III, B-IV, C-I, D-II
- (2) A-III, B-I, C-IV, D-II
- (3) A-II, B-I, C-IV, D-III
- (4) A-II, B-III, C-IV, D-I

168 Which one of the following techniques does not serve the purpose of early diagnosis of a disease for its early treatment?

- (1) Polymerase Chain Reaction (PCR) technique
- (2) Enzyme Linked Immuno-Sorbent Assay (ELISA) technique
- (3) Recombinant DNA Technology
- (4) Serum and Urine analysis

169 Given below are two statements:

Statement I: Low temperature preserves the enzyme in a temporarily inactive state whereas high temperature destroys enzymatic activity because proteins are denatured by heat.

Statement II: When the inhibitor closely resembles the substrate in its molecular structure and inhibits the activity of the enzyme, it is known as competitive inhibitor. In the light of the above statements, choose the **correct** answer from the options given below:

- (1) **Statement I** is true but **Statement II** is false.
- (2) **Statement I** is false but **Statement II** is true.
- (3) Both **Statement I** and **Statement II** are true.
- (4) Both **Statement I** and **Statement II** are false.

170 Given below are two statements: one is labelled as **Assertion A** and the other is labelled as **Reason R**.

Assertion A: Endometrium is necessary for implantation of blastocyst.

Reason R: In the absence of fertilization, the corpus luteum degenerates that causes disintegration of endometrium.

In the light of the above statements, choose the **correct** answer from the options given below:

- (1) **A** is true but **R** is false.
- (2) **A** is false but **R** is true.
- (3) Both **A** and **R** are true and **R** is the correct explanation of **A**.
- (4) Both **A** and **R** are true but **R** is NOT the correct explanation of **A**.

171 Given below are two statements: one is labelled as **Assertion A** and the other is labelled as **Reason R**.

Assertion A: Amniocentesis for sex determination is one of the strategies of Reproductive and Child Health Care Programme.

Reason R: Ban on amniocentesis checks increasing menace of female foeticide.

In the light of the above statements, choose the **correct** answer from the options given below:

- (1) **A** is true but **R** is false.
- (2) **A** is false but **R** is true.
- (3) Both **A** and **R** are true and **R** is the correct explanation of **A**.
- (4) Both **A** and **R** are true and **R** is NOT the correct explanation of **A**.

172 Which of the following statements is correct?

- (1) Presence of large amount of nutrients in water restricts 'Algal Bloom'
- (2) Algal Bloom decreases fish mortality
- (3) Eutrophication refers to increase in domestic sewage and waste water in lakes.
- (4) Biomagnification refers to increase in concentration of the toxicant at successive trophic levels.

173 Which of the following statements are correct regarding female reproductive cycle?

- A. In non-primate mammals cyclical changes during reproduction are called oestrus cycle.
- B. First menstrual cycle begins at puberty and is called menopause.
- C. Lack of menstruation may be indicative of pregnancy.
- D. Cyclic menstruation extends between menarche and menopause.

Choose the **most appropriate** answer from the options given below:

- (1) A, B and C only
- (2) A, C and D only
- (3) A and D only
- (4) A and B only

174 Match **List I** with **List II**.

List I	List II
A. CCK	I. Kidney
B. GIP	II. Heart
C. ANF	III. Gastric gland
D. ADH	IV. Pancreas

Choose the **correct** answer from the options given below:

- (1) A-II, B-IV, C-I, D-III
- (2) A-IV, B-II, C-III, D-I
- (3) A-IV, B-III, C-II, D-I
- (4) A-III, B-II, C-IV, D-I

175 Given below are two statements:

Statement I: In prokaryotes, the positively charged DNA is held with some negatively charged proteins in a region called nucleoid.

Statement II: In eukaryotes, the negatively charged DNA is wrapped around the positively charged histone octamer to form nucleosome.

In the light of the above statements, choose the **correct** answer from the options given below:

- (1) **Statement I** is correct but **Statement II** is false.
- (2) **Statement I** incorrect but **Statement II** is true.
- (3) Both **Statement I** and **Statement II** are true.
- (4) Both **Statement I** and **Statement II** are false.

176 Match **List I** with **List II**.

List I (Type of Joint)	List II (Found between)
A. Cartilaginous Joint	I. Between flat skull bones
B. Ball and Socket Joint	II. Between adjacent vertebrae in vertebral column
C. Fibrous Joint	III. Between carpal and metacarpal of thumb
D. Saddle Joint	IV. Between Humerus and Pectoral girdle

Choose the **correct** answer from the options given below:

- (1) A-I, B-IV, C-III, D-II
- (2) A-II, B-IV, C-III, D-I
- (3) A-III, B-I, C-II, D-IV
- (4) A-II, B-IV, C-I, D-III

177 Given below are two statements:

Statement I: Ligaments are dense irregular tissue.

Statement II: Cartilage is dense regular tissue.

In the light of the above statements, choose the **correct** answer from the options given below:

- (1) **Statement I** is true but **Statement II** is false.
- (2) **Statement I** is false but **Statement II** is true.
- (3) Both **Statement I** and **Statement II** are true.
- (4) Both **Statement I** and **Statement II** are false.

178 In which blood corpuscles, the HIV undergoes replication and produces progeny viruses?

- | | |
|--------------------------|-------------------|
| (1) Basophils | (2) Eosinophils |
| (3) T _H cells | (4) B-lymphocytes |

179 Radial symmetry is NOT found in adults of phylum _____.

- | | |
|------------------|-------------------|
| (1) Coelenterata | (2) Echinodermata |
| (3) Ctenophora | (4) Hemichordata |

180 Which of the following functions is carried out by cytoskeleton in a cell?

- (1) Motility
- (2) Transportation
- (3) Nuclear division
- (4) Protein synthesis

181 Given below are two statements:

Statement I: Vas deferens receives a duct from seminal vesicle and opens into urethra as the ejaculatory duct.

Statement II: The cavity of the cervix is called cervical canal which along with vagina forms birth canal.

In the light of the above statements, choose the **correct** answer from the options given below:

- (1) **Statement I** is correct but **Statement II** is false.
- (2) **Statement I** incorrect but **Statement II** is true.
- (3) Both **Statement I** and **Statement II** are true.
- (4) Both **Statement I** and **Statement II** are false.

182 Select the correct group/set of Australian Marsupials exhibiting adaptive radiation.

- (1) Mole, Flying squirrel, Tasmanian tiger cat
- (2) Lemur, Anteater, Wolf
- (3) Tasmanian wolf, Bobcat, Marsupial mole
- (4) Numbat, Spotted cuscus, Flying phalanger

183 Given below are two statements:

Statement I: Electrostatic precipitator is most widely used in thermal power plant.

Statement II: Electrostatic precipitator in thermal power plant removes ionising radiations

In the light of the above statements, choose the **most appropriate** answer from the options given below:

- (1) **Statement I** is correct but **Statement II** is incorrect.
- (2) **Statement I** incorrect but **Statement II** is correct.
- (3) Both **Statement I** and **Statement II** are correct.
- (4) Both **Statement I** and **Statement II** are incorrect.

184 Given below are two statements:

Statement I: RNA mutates at a faster rate.

Statement II: Viruses having RNA genome and shorter life span mutate and evolve faster.

In the light of the above statements, choose the **correct** answer from the options given below:

- (1) **Statement I** is true but **Statement II** is false.
- (2) **Statement I** false but **Statement II** is true.
- (3) Both **Statement I** and **Statement II** are true.
- (4) Both **Statement I** and **Statement II** are false.

185 Match **List I** with **List II** with respect to human eye.

List I		List II
A. Fovea	I.	Visible coloured portion of eye that regulates diameter of pupil.
B. Iris	II.	External layer of eye formed of dense connective tissue.
C. Blind spot	III.	Point of greatest visual acuity or resolution.
D. Sclera	IV.	Point where optic nerve leaves the eyeball and photoreceptor cells are absent.

Choose the **correct** answer from the options given below:

- (1) A-I, B-IV, C-III, D-II
- (2) A-II, B-I, C-III, D-IV
- (3) A-III, B-I, C-IV, D-II
- (4) A-IV, B-III, C-II, D-I

186 Select the correct statements.

- A. Tetrad formation is seen during Leptotene.
- B. During Anaphase, the centromeres split and chromatids separate.
- C. Terminalization takes place during Pachytene.
- D. Nucleolus, Golgi complex and ER are reformed during Telophase.
- E. Crossing over takes place between sister chromatids of homologous chromosome.

Choose the **correct** answer from the options given below:

- (1) A, C and E only
- (2) B and E only
- (3) A and C only
- (4) B and D only

187 Select the correct statements with reference to chordates.

- A. Presence of a mid-dorsal, solid and double nerve cord.
- B. Presence of closed circulatory system.
- C. Presence of paired pharyngeal gillslits.
- D. Presence of dorsal heart
- E. Triploblastic pseudocoelomate animals.

Choose the **correct** answer from the options given below:

- (1) B, D and E only
- (2) C, D and E only
- (3) A, C and D only
- (4) B and C only

188 In cockroach, excretion is brought about by-

- A. Phallic gland B. Ureose gland
- C. Nephrocytes D. Fat body
- E. Collateral glands

Choose the **correct** answer from the options given below:

- (1) B, C and D only
- (2) B and D only
- (3) A and E only
- (4) A, B and E only

189 Match List I with List II.

List I	List II
A. Mast cells	I. Ciliated epithelium
B. Inner surface of bronchiole	II. Areolar connective tissue
C. Blood	III. Cuboidal epithelium
D. Tubular parts of nephron	IV. specialised connective tissue

Choose the **correct** answer from the options give below:

- (1) A-II, B-I, C-IV, D-III
- (2) A-III, B-IV, C-II, D-I
- (3) A-I, B-II, C-IV, D-III
- (4) A-II, B-III, C-I, D-IV

190 Given below are two statements:

Statement I: During G_0 phase of cell cycle, the cell is metabolically inactive.

Statement II: The centrosome undergoes duplication during S phase of interphase.

In the light of the above statements, choose the **most appropriate** answer from the options given below:

- (1) **Statement I** is correct but **Statement II** is incorrect.
- (2) **Statement I** is incorrect but **Statement II** is correct.
- (3) Both **Statement I** and **Statement II** are correct.
- (4) Both **Statement I** and **Statement II** are incorrect.

191 Which one of the following is NOT an advantage of inbreeding?

- (1) Elimination of less desirable genes and accumulation of superior genes takes place due to it.
- (2) It decreases the productivity of inbred population, after continuous inbreeding.
- (3) It decreases homozygosity.
- (4) It exposes harmful recessive genes that are eliminated by selection.

192 Which of the following is characteristic feature of cockroach regarding sexual dimorphism ?

- (1) Presence of sclerites
- (2) Presence of anal cerci
- (3) Dark brown body colour and anal cerci
- (4) Presence of anal styles

193 The parts of human brain that helps in regulation of sexual behaviour, expression of excitement, pleasure, rage, fear etc. are :

- (1) Brain stem & epithalamus
- (2) Corpus callosum and thalamus
- (3) Limbic system & hypothalamus
- (4) Corpora quadrigemina & hippocampus

194 Which of the following statements are correct ?

- A. Basophils are most abundant cells of the total WBCs
- B. Basophils secrete histamine, serotonin and heparin
- C. Basophils are involved in inflammatory response
- D. Basophils have kidney shaped nucleus
- E. Basophils are agranulocytes

Choose the **correct** answer from the options given below:

- (1) B and C only
- (2) A and B only
- (3) D and E only
- (4) C and E only

195 Which one of the following is the sequence on corresponding coding strand, if the sequence on mRNA formed is as follows 5' AUCGAUCGAUCGAUCG AUCG AUCG 3'?

- (1) 5' ATCGATCGATCGATCGATCG ATCGATCG 3'
- (2) 3' ATCGATCGATCGATCGATCG ATCGATCG 5'
- (3) 5' UAGCUAGCUAGCUAGCUA GCUAGC UAGC 3'
- (4) 3' UAGCUAGCUAGCUAGCUA GCUAGCUAGC 5'



196 Match List I with List II.

List I	List II
A. Logistic growth	I. Unlimited resource availability condition
B. Exponential growth	II. Limited resource availability condition
C. Expanding age pyramid	III. The percent individuals of pre-reproductive age is largest followed by reproductive and post reproductive age groups
D. Stable age pyramid	IV. The percent individuals of pre-reproductives and reproductive age group are same

Choose the **correct** answer from the options given below:

- (1) A-II, B-IV, C-I, D-III
- (2) A-II, B-IV, C-III, D-I
- (3) A-II, B-I, C-III, D-IV
- (4) A-II, B-III, C-I, D-IV

197 Which of the following are NOT under the control of thyroid hormone?

- A. Maintenance of water and electrolyte balance
- B. Regulation of basal metabolic rate
- C. Normal rhythm of sleep-wake cycle
- D. Development of immune system
- E. Support the process of R.B.Cs formation

Choose the **correct** answer from the options given below:

- (1) C and D only
- (2) D and E only
- (3) A and D only
- (4) B and C only

198 Which of the following statements are correct?

- A. An excessive loss of body fluid from the body switches off osmoreceptors.
- B. ADH facilitates water reabsorption to prevent diuresis.
- C. ANF causes vasodilation.
- D. ADH causes increase in blood pressure.
- E. ADH is responsible for decrease in GFR.

Choose the **correct** answer from the options given below:

- (1) A, B and E only
- (2) C, D and E only
- (3) A and B only
- (4) B, C and D only

199 Which of the following statements are correct regarding skeletal muscle?

- A. Muscle bundles are held together by collagenous connective tissue layer called fascicle.
- B. Sarcoplasmic reticulum of muscle fibre is a store house of calcium ions.
- C. Striated appearance of skeletal muscle fibre is due to distribution pattern of actin and myosin proteins.
- D. M line is considered as functional unit of contraction called sarcomere.

Choose the **most appropriate** answer from the options given below:

- (1) A, C and D only
- (2) C and D only
- (3) A, B and C only
- (4) B and C only

200 The unique mammalian characteristics are:

- (1) hairs, pinna and indirect development
- (2) pinna, monocondylic skull and mammary glands
- (3) hairs, tympanic membrane and mammary glands
- (4) hairs, pinna and mammary glands

SPACE FOR ROUGH WORK



SPACE FOR ROUGH WORK
