

**S1**  
DUGRI

Corporate Office : Aakash Tower, 8, Pusa Road, New Delhi-110005 | Ph.: 011-47623456

## Questions & Answers

Time : 3 hrs. 20 Min.

M.M. : 720

*for*

## NEET (UG)-2024

### Important Instructions :

- The test is of **3 hours 20 minutes** duration and the Test Booklet contains **200** multiple-choice questions (four options with a single correct answer) from **Physics, Chemistry and Biology (Botany and Zoology)**. 50 questions in each subject are divided into **two Sections (A and B)** as per details given below:
  - Section-A** shall consist of **35 (Thirty-five)** Questions in each subject (Question Nos-1 to 35, 51 to 85, 101 to 135 and 151 to 185). All Questions are compulsory.
  - Section-B** shall consist of **15 (Fifteen)** questions in each subject (Question Nos- 36 to 50, 86 to 100, 136 to 150 and 186 to 200). In **Section B**, a candidate needs to **attempt any 10 (Ten)** questions out of **15 (Fifteen)** in each subject.

**Candidates are advised to read all 15 questions in each subject of Section B** before they start attempting the question paper. In the event of a candidate attempting more than ten questions, **the first ten questions answered by the candidate shall be evaluated.**
- Each question carries **4 marks**. For each correct response, the candidate will get **4 marks**. For each incorrect response, **one mark** will be deducted from the total scores. **The maximum marks are 720.**
- Use **Blue / Black Ball Point Pen only** for writing particulars on this page / marking responses on Answer Sheet.
- Rough work is to be done in the space provided for this purpose in the Test Booklet only.
- On completion of the test, the candidate must **hand over the Answer Sheet (ORIGINAL and OFFICE copy) to the Invigilator** before leaving the Room / Hall. The candidates are allowed to take away this Test Booklet with them.
- The CODE for this Booklet is S1. Make sure that the CODE printed on the Original Copy of the Answer Sheet is the same as that on this Test Booklet.** In case of discrepancy, the candidate should immediately report the matter to the Invigilator for replacement of both the Test Booklet and the Answer sheet.
- The candidates should ensure that the Answer Sheet is not folded. Do not make any stray marks on the Answer Sheet. Do not write your Roll No. anywhere else except in the specified space in the Test Booklet/Answer Sheet.
- Use of white fluid for correction is **NOT** permissible on the Answer Sheet.
- Each candidate must show on-demand his/her Admission Card to the Invigilator.
- No candidate, without special permission of the Centre Superintendent or Invigilator, would leave his/her seat.
- Use of Electronic/Manual Calculator is prohibited.
- The candidates are governed by all Rules and Regulations of the examination with regard to their conduct in the Examination Room / Hall. All cases of unfair means will be dealt with as per Rules and Regulations of this examination.
- No part of the Test Booklet and Answer Sheet shall be detached under any circumstances.**
- The candidates will write the Correct Test Booklet Code as given in the Test Booklet / Answer Sheet in the Attendance Sheet.

**PHYSICS**

**SECTION-A**

1. A bob is whirled in a horizontal plane by means of a string with an initial speed of  $\omega$  rpm. The tension in the string is  $T$ . If speed becomes  $2\omega$  while keeping the same radius, the tension in the string becomes:

- (1)  $\sqrt{2}T$  (2)  $T$   
(3)  $4T$  (4)  $\frac{T}{4}$

**Answer (3)**

2. A wire of length ' $l$ ' and resistance  $100 \Omega$  is divided into 10 equal parts. The first 5 parts are connected in series while the next 5 parts are connected in parallel. The two combinations are again connected in series. The resistance of this final combination is:

- (1)  $60 \Omega$  (2)  $26 \Omega$   
(3)  $52 \Omega$  (4)  $55 \Omega$

**Answer (3)**

3. A thermodynamic system is taken through the cycle  $abcd$ . The work done by the gas along the path  $bc$  is:

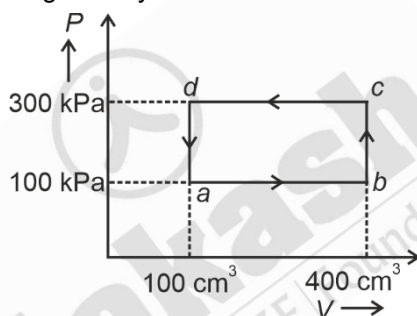

- (1)  $-60 \text{ J}$   
(2) Zero  
(3)  $30 \text{ J}$   
(4)  $-90 \text{ J}$

**Answer (2)**

4. A logic circuit provides the output  $Y$  as per the following truth table :

A	B	Y
0	0	1
0	1	0
1	0	1
1	1	0

The expression for the output  $Y$  is :

- (1)  $B$   
(2)  $A.B + \bar{A}$   
(3)  $A.\bar{B} + \bar{A}$   
(4)  $\bar{B}$

**Answer (4)**



10. At any instant of time  $t$ , the displacement of any particle is given by  $2t - 1$  (SI unit) under the influence of force of 5 N. The value of instantaneous power is (in SI unit):
- (1) 6 (2) 10  
(3) 5 (4) 7

**Answer (2)**

11. A thin flat circular disc of radius 4.5 cm is placed gently over the surface of water. If surface tension of water is  $0.07 \text{ N m}^{-1}$ , then the excess force required to take it away from the surface is
- (1) 99 N (2) 19.8 mN  
(3) 198 N (4) 1.98 mN

**Answer (2)**

12. A wheel of a bullock cart is rolling on a level road as shown in the figure below. If its linear speed is  $v$  in the direction shown, which one of the following options is correct ( $P$  and  $Q$  are any highest and lowest points on the wheel, respectively)?

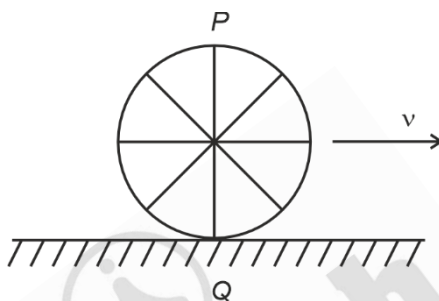

- (1) Point  $P$  has zero speed (2) Point  $P$  moves slower than point  $Q$   
(3) Point  $P$  moves faster than point  $Q$  (4) Both the points  $P$  and  $Q$  move with equal speed

**Answer (3)**

13. Given below are two statements: one is labelled as **Assertion A** and the other is labelled as **Reason R**.  
**Assertion A:** The potential ( $V$ ) at any axial point, at 2 m distance ( $r$ ) from the centre of the dipole of dipole moment vector  $\vec{P}$  of magnitude,  $4 \times 10^{-6} \text{ C m}$ , is  $\pm 9 \times 10^3 \text{ V}$ .

(Take  $\frac{1}{4\pi\epsilon_0} = 9 \times 10^9 \text{ SI units}$ )

**Reason R:**  $V = \pm \frac{2P}{4\pi\epsilon_0 r^2}$ , where  $r$  is the distance of any axial point, situated at 2 m from the centre of the dipole.

In the light of the above statements, choose the **correct** answer from the options given below:

- (1) A is false but R is true.  
(2) Both A and R are true and R is the correct explanation of A.  
(3) Both A and R are true and R is NOT the correct explanation of A.  
(4) A is true but R is false.

**Answer (4)**

14. If  $x = 5 \sin\left(\pi t + \frac{\pi}{3}\right) \text{ m}$  represents the motion of a particle executing simple harmonic motion, the amplitude and time period of motion, respectively, are

- (1) 5 m, 1 s (2) 5 cm, 2 s  
(3) 5 m, 2 s (4) 5 cm, 1 s

**Answer (3)**

15. An unpolarised light beam strikes a glass surface at Brewster's angle. Then
- (1) The reflected light will be completely polarised but the refracted light will be partially polarised.
  - (2) The reflected light will be partially polarised.
  - (3) The refracted light will be completely polarised.
  - (4) Both the reflected and refracted light will be completely polarised.

**Answer (1)**

16. The quantities which have the same dimensions as those of solid angle are:
- (1) angular speed and stress
  - (2) strain and angle
  - (3) stress and angle
  - (4) strain and arc

**Answer (2)**

17. In a uniform magnetic field of 0.049 T, a magnetic needle performs 20 complete oscillations in 5 seconds as shown. The moment of inertia of the needle is  $9.8 \times 10^{-6} \text{ kg m}^2$ . If the magnitude of magnetic moment of the needle is  $x \times 10^{-5} \text{ Am}^2$ , then the value of 'x' is :

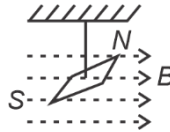

- (1)  $1280\pi^2$
- (2)  $5\pi^2$
- (3)  $128\pi^2$
- (4)  $50\pi^2$

**Answer (1)**

18. A thin spherical shell is charged by some source. The potential difference between the two points C and P (in V) shown in the figure is:

(Take  $\frac{1}{4\pi\epsilon_0} = 9 \times 10^9 \text{ SI units}$ )

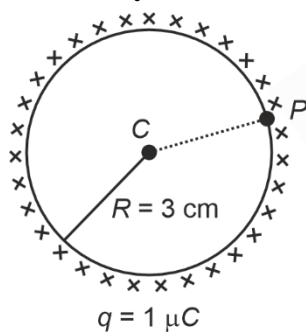

- (1) Zero
- (2)  $3 \times 10^5$
- (3)  $1 \times 10^5$
- (4)  $0.5 \times 10^5$

**Answer (1)**

19. The moment of inertia of a thin rod about an axis passing through its mid point and perpendicular to the rod is  $2400 \text{ g cm}^2$ . The length of the 400 g rod is nearly:

- (1) 72.0 cm
- (2) 8.5 cm
- (3) 17.5 cm
- (4) 20.7 cm

**Answer (2)**

20. Given below are two statements:

**Statement I:** Atoms are electrically neutral as they contain equal number of positive and negative charges.

**Statement II:** Atoms of each element are stable and emit their characteristic spectrum.

In the light of the above statements, choose the *most appropriate* answer from the options given below.

- (1) Statement I is incorrect but Statement II is correct
- (2) Both Statement I and Statement II are correct
- (3) Both Statement I and Statement II are incorrect
- (4) Statement I is correct but Statement II is incorrect

**Answer (4)**

21. Match List I with List II.

	<b>List I (Spectral Lines of Hydrogen for transitions from)</b>		<b>List II (Wavelengths (nm))</b>
A.	$n_2 = 3$ to $n_1 = 2$	I.	410.2
B.	$n_2 = 4$ to $n_1 = 2$	II.	434.1
C.	$n_2 = 5$ to $n_1 = 2$	III.	656.3
D.	$n_2 = 6$ to $n_1 = 2$	IV.	486.1

Choose the correct answer from the options given below:

- (1) A-I, B-II, C-III, D-IV  
 (2) A-II, B-I, C-IV, D-III  
 (3) A-III, B-IV, C-II, D-I  
 (4) A-IV, B-III, C-I, D-II

**Answer (3)**

22. Match List-I with List-II.

<b>List-I (Material)</b>	<b>List-II (Susceptibility (<math>\chi</math>))</b>
A. Diamagnetic	I. $\chi = 0$
B. Ferromagnetic	II. $0 > \chi \geq -1$
C. Paramagnetic	III. $\chi \gg 1$
D. Non-magnetic	IV. $0 < \chi < \epsilon$ (a small positive number)

Choose the correct answer from the options given below

- (1) A-IV, B-III, C-II, D-I  
 (2) A-II, B-III, C-IV, D-I  
 (3) A-II, B-I, C-III, D-IV  
 (4) A-III, B-II, C-I, D-IV

**Answer (2)**

23. Consider the following statements A and B and identify the correct answer:

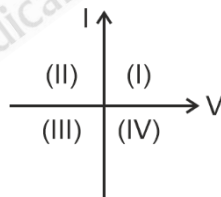

- A. For a solar-cell, the I-V characteristics lies in the IV quadrant of the given graph.  
 B. In a reverse biased *pn* junction diode, the current measured in ( $\mu\text{A}$ ), is due to majority charge carriers.

- (1) Both A and B are incorrect  
 (2) A is correct but B is incorrect  
 (3) A is incorrect but B is correct  
 (4) Both A and B are correct

**Answer (2)**

24. If the monochromatic source in Young's double slit experiment is replaced by white light, then

- (1) All bright fringes will be of equal width  
 (2) Interference pattern will disappear  
 (3) There will be a central dark fringe surrounded by a few coloured fringes  
 (4) There will be a central bright white fringe surrounded by a few coloured fringes

**Answer (4)**

25. A light ray enters through a right angled prism at point  $P$  with the angle of incidence  $30^\circ$  as shown in figure. It travels through the prism parallel to its base  $BC$  and emerges along the face  $AC$ . The refractive index of the prism is:

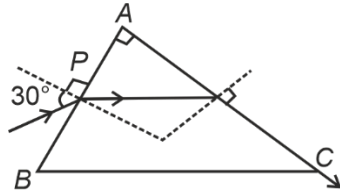

- (1)  $\frac{\sqrt{3}}{2}$  (2)  $\frac{\sqrt{5}}{4}$   
 (3)  $\frac{\sqrt{5}}{2}$  (4)  $\frac{\sqrt{3}}{4}$

**Answer (3)**

26. The terminal voltage of the battery, whose emf is 10 V and internal resistance  $1 \Omega$ , when connected through an external resistance of  $4 \Omega$  as shown in the figure is:

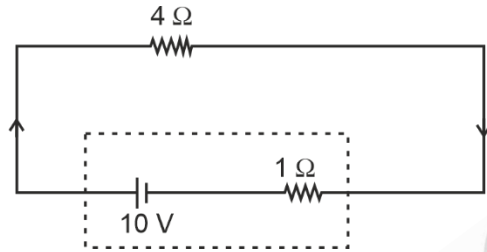

- (1) 10 V (2) 4 V  
 (3) 6 V (4) 8 V

**Answer (4)**

27. A horizontal force 10 N is applied to a block A as shown in figure. The mass of blocks A and B are 2 kg and 3 kg respectively. The blocks slide over a frictionless surface. The force exerted by block A on block B is :

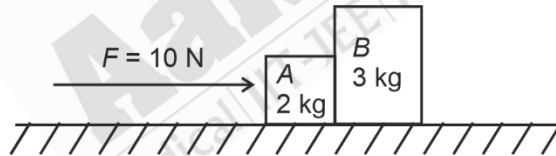

- (1) 10 N (2) Zero  
 (3) 4 N (4) 6 N

**Answer (4)**

28. Two bodies A and B of same mass undergo completely inelastic one dimensional collision. The body A moves with velocity  $v_1$  while body B is at rest before collision. The velocity of the system after collision is  $v_2$ . The ratio  $v_1 : v_2$  is

- (1) 1 : 4 (2) 1 : 2  
 (3) 2 : 1 (4) 4 : 1

**Answer (3)**

29. The output (Y) of the given logic gate is similar to the output of an/a

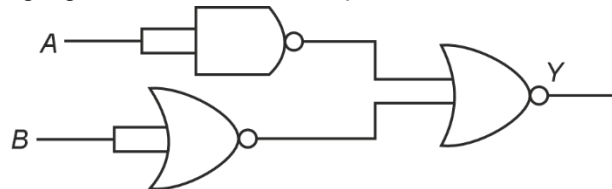

- (1) AND gate (2) NAND gate  
 (3) NOR gate (4) OR gate

**Answer (1)**

30. In the following circuit, the equivalent capacitance between terminal A and terminal B is :

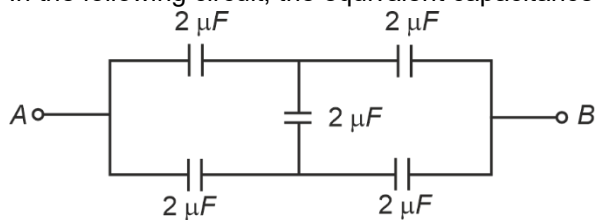

- (1)  $4 \mu F$  (2)  $2 \mu F$   
(3)  $1 \mu F$  (4)  $0.5 \mu F$

**Answer (2)**

31. A particle moving with uniform speed in a circular path maintains:

- (1) Varying velocity and varying acceleration (2) Constant velocity  
(3) Constant acceleration (4) Constant velocity but varying acceleration

**Answer (1)**

32. The maximum elongation of a steel wire of 1 m length if the elastic limit of steel and its Young's modulus, respectively, are  $8 \times 10^8 \text{ N m}^{-2}$  and  $2 \times 10^{11} \text{ N m}^{-2}$ , is:

- (1) 8 mm (2) 4 mm  
(3) 0.4 mm (4) 40 mm

**Answer (2)**

33.  ${}_{82}^{290}\text{X} \xrightarrow{\alpha} \text{Y} \xrightarrow{e^+} \text{Z} \xrightarrow{\beta^-} \text{P} \xrightarrow{e^-} \text{Q}$

In the nuclear emission stated above, the mass number and atomic number of the product Q respectively, are

- (1) 286, 81 (2) 280, 81  
(3) 286, 80 (4) 288, 82

**Answer (1)**

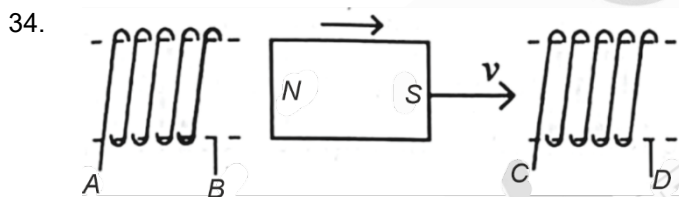

Solenoid-1

Solenoid-2

In the above diagram, a strong bar magnet is moving towards solenoid-2 from solenoid-1. The direction of induced current in solenoid-1 and that in solenoid-2, respectively, are through the directions:

- (1) BA and DC (2) AB and DC  
(3) BA and CD (4) AB and CD

**Answer (2)**

35. A tightly wound 100 turns coil of radius 10 cm carries a current of 7 A. The magnitude of the magnetic field at the centre of the coil is (Take permeability of free space as  $4\pi \times 10^{-7}$  SI units):

- (1) 44 T (2) 44 mT  
(3) 4.4 T (4) 4.4 mT

**Answer (4)**

## SECTION-B

36. The property which is not of an electromagnetic wave travelling in free space is that:

- (1) They originate from charges moving with uniform speed  
(2) They are transverse in nature  
(3) The energy density in electric field is equal to energy density in magnetic field  
(4) They travel with a speed equal to  $\frac{1}{\sqrt{\mu_0 \epsilon_0}}$

**Answer (1)**



37. The velocity ( $v$ ) – time ( $t$ ) plot of the motion of a body is shown below:

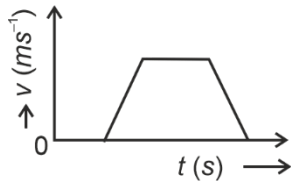

The acceleration ( $a$ ) – time ( $t$ ) graph that best suits this motion is :

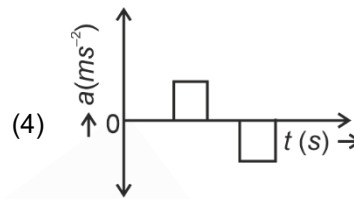
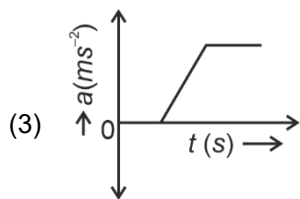
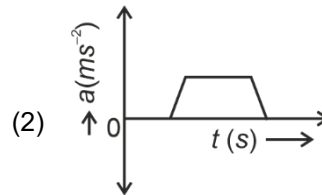
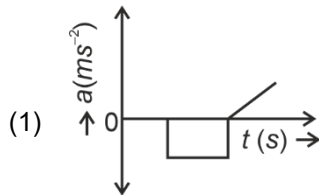

**Answer (4)**

38. A  $10\ \mu\text{F}$  capacitor is connected to a  $210\ \text{V}$ ,  $50\ \text{Hz}$  source as shown in figure. The peak current in the circuit is nearly ( $\pi = 3.14$ ):

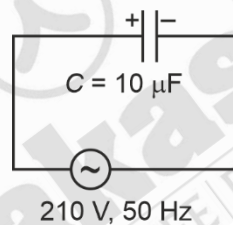

(1)  $0.35\ \text{A}$

(2)  $0.58\ \text{A}$

(3)  $0.93\ \text{A}$

(4)  $1.20\ \text{A}$

**Answer (3)**

39. The following graph represents the  $T$ - $V$  curves of an ideal gas (where  $T$  is the temperature and  $V$  the volume) at three pressures  $P_1$ ,  $P_2$  and  $P_3$  compared with those of Charles's law represented as dotted lines.

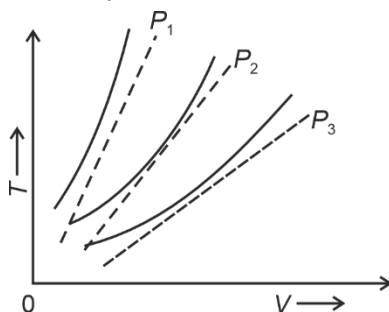

Then the correct relation is:

(1)  $P_1 > P_2 > P_3$

(2)  $P_3 > P_2 > P_1$

(3)  $P_1 > P_3 > P_2$

(4)  $P_2 > P_1 > P_3$

**Answer (1)**



45. A metallic bar of Young's modulus,  $0.5 \times 10^{11} \text{ N m}^{-2}$  and coefficient of linear thermal expansion  $10^{-5} \text{ }^\circ\text{C}^{-1}$ , length 1 m and area of cross-section  $10^{-3} \text{ m}^2$  is heated from  $0^\circ\text{C}$  to  $100^\circ\text{C}$  without expansion or bending. The compressive force developed in it is :
- (1)  $2 \times 10^3 \text{ N}$  (2)  $5 \times 10^3 \text{ N}$   
(3)  $50 \times 10^3 \text{ N}$  (4)  $100 \times 10^3 \text{ N}$

**Answer (3)**

46. A parallel plate capacitor is charged by connecting it to a battery through a resistor. If  $I$  is the current in the circuit, then in the gap between the plates:
- (1) Displacement current of magnitude greater than  $I$  flows but can be in any direction  
(2) There is no current  
(3) Displacement current of magnitude equal to  $I$  flows in the same direction as  $I$   
(4) Displacement current of magnitude equal to  $I$  flows in a direction opposite to that of  $I$

**Answer (3)**

47. A sheet is placed on a horizontal surface in front of a strong magnetic pole. A force is needed to:

- A. hold the sheet there if it is magnetic.  
B. hold the sheet there if it is non-magnetic.  
C. move the sheet away from the pole with uniform velocity if it is conducting.  
D. move the sheet away from the pole with uniform velocity if it is both, non-conducting and non-polar.

Choose the correct statement(s) from the options given below:

- (1) C only (2) B and D only  
(3) A and C only (4) A, C and D only

**Answer (3)**

48. If the mass of the bob in a simple pendulum is increased to thrice its original mass and its length is made half its original length, then the new time period of oscillation is  $\frac{x}{2}$  times its original time period. Then the value of  $x$  is:

- (1) 4 (2)  $\sqrt{3}$   
(3)  $\sqrt{2}$  (4)  $2\sqrt{3}$

**Answer (3)**

49. An iron bar of length  $L$  has magnetic moment  $M$ . It is bent at the middle of its length such that the two arms make an angle  $60^\circ$  with each other. The magnetic moment of this new magnet is :

- (1)  $\frac{M}{\sqrt{3}}$  (2)  $M$   
(3)  $\frac{M}{2}$  (4)  $2M$

**Answer (3)**

50. A small telescope has an objective of focal length 140 cm and an eye piece of focal length 5.0 cm. The magnifying power of telescope for viewing a distant object is:

- (1) 32 (2) 34  
(3) 28 (4) 17

**Answer (3)**

**CHEMISTRY**

**SECTION-A**

51. Identify the correct reagents that would bring about the following transformation.

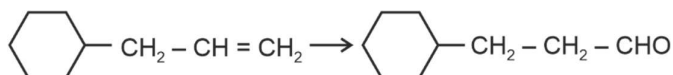

- |   |  |
|---|--|
| (1) (i) $\text{H}_2\text{O}/\text{H}^+$<br>(ii) PCC   | (2) (i) $\text{H}_2\text{O}/\text{H}^+$<br>(ii) $\text{CrO}_3$   |
| (3) (i) $\text{BH}_3$<br>(ii) $\text{H}_2\text{O}_2 / \overset{\ominus}{\text{O}}\text{H}$<br>(iii) PCC | (4) (i) $\text{BH}_3$<br>(ii) $\text{H}_2\text{O}_2 / \overset{\ominus}{\text{O}}\text{H}$<br>(iii) alk. $\text{KMnO}_4$<br>(iv) $\text{H}_3\text{O}^{\oplus}$ |

**Answer (3)**

52. The compound that will undergo  $\text{S}_{\text{N}}1$  reaction with the fastest rate is



**Answer (1)**

53. Match List I with List II.

**List I**  
**(Molecule)**

- A. ethane  
B. ethene  
C. carbon molecule,  $\text{C}_2$   
D. ethyne

**List II**  
**(Number and types of bond/s between two carbon atoms)**

- I. one  $\sigma$ -bond and two  $\pi$ -bonds  
II. two  $\pi$ -bonds  
III. one  $\sigma$ -bond  
IV. one  $\sigma$ -bond and one  $\pi$ -bond

Choose the correct answer from the options given below:

- |                            |                            |
|----------------------------|----------------------------|
| (1) A-III, B-IV, C-I, D-II | (2) A-I, B-IV, C-II, D-III |
| (3) A-IV, B-III, C-II, D-I | (4) A-III, B-IV, C-II, D-I |

**Answer (4)**

54. Given below are two statements :

**Statement I:** Both  $[\text{Co}(\text{NH}_3)_6]^{3+}$  and  $[\text{CoF}_6]^{3-}$  complexes are octahedral but differ in their magnetic behaviour.

**Statement II:**  $[\text{Co}(\text{NH}_3)_6]^{3+}$  is diamagnetic whereas  $[\text{CoF}_6]^{3-}$  is paramagnetic.

In the light of the above statements, choose the correct answer from the options given below:

- (1) Statement I is false but Statement II is true      (2) Both Statement I and Statement II are true  
 (3) Both Statement I and Statement II are false      (4) Statement I is true but Statement II is false

**Answer (2)**

55. Match List I with List II.

List I (Compound)	List II (Shape/geometry)
A. $\text{NH}_3$	I. Trigonal Pyramidal
B. $\text{BrF}_5$	II. Square Planar
C. $\text{XeF}_4$	III. Octahedral
D. $\text{SF}_6$	IV. Square Pyramidal

Choose the correct answer from the options given below:

- (1) A-II, B-III, C-IV, D-I      (2) A-I, B-IV, C-II, D-III  
 (3) A-II, B-IV, C-III, D-I      (4) A-III, B-IV, C-I, D-II

**Answer (2)**

56. Arrange the following elements in increasing order of first ionization enthalpy:

Li, Be, B, C, N

Choose the correct answer from the options given below:

- (1)  $\text{Li} < \text{Be} < \text{N} < \text{B} < \text{C}$       (2)  $\text{Li} < \text{Be} < \text{B} < \text{C} < \text{N}$   
 (3)  $\text{Li} < \text{B} < \text{Be} < \text{C} < \text{N}$       (4)  $\text{Li} < \text{Be} < \text{C} < \text{B} < \text{N}$

**Answer (3)**

57. The reagents with which glucose does **not** react to give the corresponding tests/products are

- A. Tollen's reagent  
 B. Schiff's reagent  
 C. HCN  
 D.  $\text{NH}_2\text{OH}$   
 E.  $\text{NaHSO}_3$

Choose the correct options from the given below:

- (1) E and D      (2) B and C  
 (3) A and D      (4) B and E

**Answer (4)**



63. Match List I with List II.

List-I (Process)	List-II (Conditions)
A. Isothermal process	I. No heat exchange
B. Isochoric process	II. Carried out at constant temperature
C. Isobaric process	III. Carried out at constant volume
D. Adiabatic process	IV. Carried out at constant pressure

Choose the correct answer from the options given below:

- |                            |                            |
|----------------------------|----------------------------|
| (1) A-II, B-III, C-IV, D-I | (2) A-IV, B-III, C-II, D-I |
| (3) A-IV, B-II, C-III, D-I | (4) A-I, B-II, C-III, D-IV |

**Answer (1)**

64. The energy of an electron in the ground state ( $n = 1$ ) for  $\text{He}^+$  ion is  $-x$  J, then that for an electron in  $n = 2$  state for  $\text{Be}^{3+}$  ion in J is

- |                     |           |
|---------------------|-----------|
| (1) $-\frac{4}{9}x$ | (2) $-x$  |
| (3) $-\frac{x}{9}$  | (4) $-4x$ |

**Answer (2)**

65. Match List I with List II.

List I (Conversion)	List II (Number of Faraday required)
A. 1 mol of $\text{H}_2\text{O}$ to $\text{O}_2$	I. 3F
B. 1 mol of $\text{MnO}_4^-$ to $\text{Mn}^{2+}$	II. 2F
C. 1.5 mol of Ca from molten $\text{CaCl}_2$	III. 1F
D. 1 mol of $\text{FeO}$ to $\text{Fe}_2\text{O}_3$	IV. 5F

Choose the correct answer from the options given below:

- |                            |                            |
|----------------------------|----------------------------|
| (1) A-III, B-IV, C-II, D-I | (2) A-II, B-IV, C-I, D-III |
| (3) A-III, B-IV, C-I, D-II | (4) A-II, B-III, C-I, D-IV |

**Answer (2)**

66. 1 gram of sodium hydroxide was treated with 25 mL of 0.75 M HCl solution, the mass of sodium hydroxide left unreacted is equal to

- |            |             |
|------------|-------------|
| (1) 200 mg | (2) 750 mg  |
| (3) 250 mg | (4) Zero mg |

**Answer (3)**

67. The most stable carbocation among the following is :

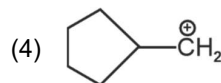
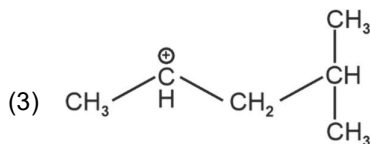
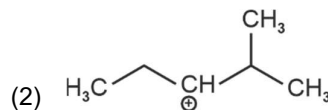
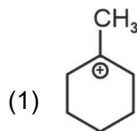

**Answer (1)**

68. In which of the following equilibria,  $K_p$  and  $K_c$  are **NOT** equal?

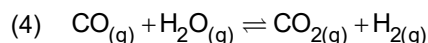
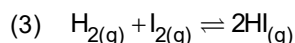
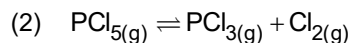
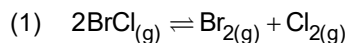

**Answer (2)**

69. The  $E^\circ$  value for the  $\text{Mn}^{3+}/\text{Mn}^{2+}$  couple is more positive than that of  $\text{Cr}^{3+}/\text{Cr}^{2+}$  or  $\text{Fe}^{3+}/\text{Fe}^{2+}$  due to change of

(1)  $d^3$  to  $d^5$  configuration

(2)  $d^5$  to  $d^4$  configuration

(3)  $d^5$  to  $d^2$  configuration

(4)  $d^4$  to  $d^5$  configuration

**Answer (4)**

70. Fehling's solution 'A' is

(1) aqueous sodium citrate

(2) aqueous copper sulphate

(3) alkaline copper sulphate

(4) alkaline solution of sodium potassium tartrate (Rochelle's salt)

**Answer (2)**

71. Match List I with List II.

**List I**  
**(Reaction)**

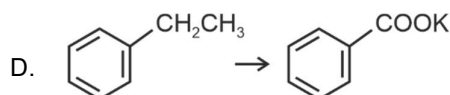
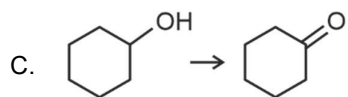
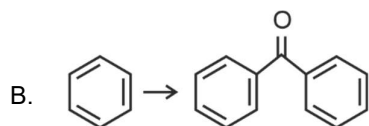
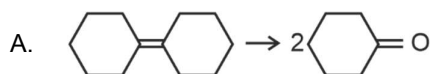

**List II**  
**(Reagents/Condition)**

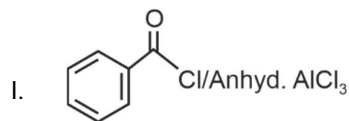

II.  $\text{CrO}_3$

III.  $\text{KMnO}_4/\text{KOH}, \Delta$

IV. (i)  $\text{O}_3$

(ii)  $\text{Zn-H}_2\text{O}$





76. Which one of the following alcohols reacts instantaneously with Lucas reagent?

- (1)  $\text{CH}_3 - \underset{\text{CH}_3}{\overset{\text{CH}_3}{\text{C}}} - \text{OH}$  (2)  $\text{CH}_3 - \text{CH}_2 - \text{CH}_2 - \text{CH}_2\text{OH}$
- (3)  $\text{CH}_3 - \text{CH}_2 - \underset{\text{CH}_3}{\text{CH}} - \text{OH}$  (4)  $\text{CH}_3 - \underset{\text{CH}_3}{\text{CH}} - \text{CH}_2\text{OH}$

**Answer (1)**

77. The Henry's law constant ( $K_H$ ) values of three gases (A, B, C) in water are 145,  $2 \times 10^{-5}$  and 35 kbar, respectively. The solubility of these gases in water follow the order:

- (1)  $A > B > C$  (2)  $B > A > C$
- (3)  $B > C > A$  (4)  $A > C > B$

**Answer (3)**

78. On heating, some solid substances change from solid to vapour state without passing through liquid state. The technique used for the purification of such solid substances based on the above principle is known as

- (1) Chromatography (2) Crystallization
- (3) Sublimation (4) Distillation

**Answer (3)**

79. Match List I with List II.

**List I (Complex)**

- A.  $[\text{Co}(\text{NH}_3)_5(\text{NO}_2)]\text{Cl}_2$
- B.  $[\text{Co}(\text{NH}_3)_5(\text{SO}_4)]\text{Br}$
- C.  $[\text{Co}(\text{NH}_3)_6][\text{Cr}(\text{CN})_6]$
- D.  $[\text{Co}(\text{H}_2\text{O})_6]\text{Cl}_3$

**List II (Type of isomerism)**

- I. Solvate isomerism
- II. Linkage isomerism
- III. Ionization isomerism
- IV. Coordination isomerism

Choose the correct answer from the options given below:

- (1) A-II, B-IV, C-III, D-I (2) A-II, B-III, C-IV, D-I
- (3) A-I, B-III, C-IV, D-II (4) A-I, B-IV, C-III, D-II

**Answer (2)**

80. Intramolecular hydrogen bonding is present in

- (1) HF (2) 
- (3) 
- (4) 

**Answer (2)**

81. Given below are two statements:

**Statement I** : Aniline does not undergo Friedel-Crafts alkylation reaction.

**Statement II** : Aniline cannot be prepared through Gabriel synthesis.

In the light of the above statements, choose the correct answer from the options given below:

- (1) Statement I is incorrect but Statement II is true
- (2) Both statement I and Statement II are true
- (3) Both Statement I and Statement II are false
- (4) Statement I is correct but Statement II is false

**Answer (2)**

82. Among Group 16 elements, which one does **NOT** show  $-2$  oxidation state?

- (1) Po
- (2) O
- (3) Se
- (4) Te

**Answer (1)**

83. Activation energy of any chemical reaction can be calculated if one knows the value of

- (1) rate constant at two different temperatures
- (2) rate constant at standard temperature
- (3) probability of collision
- (4) orientation of reactant molecules during collision

**Answer (1)**

84. 'Spin only' magnetic moment is same for which of the following ions?

- |              |              |
|--------------|--------------|
| A. $Ti^{3+}$ | B. $Cr^{2+}$ |
| C. $Mn^{2+}$ | D. $Fe^{2+}$ |
| E. $Sc^{3+}$ |              |

Choose the most appropriate answer from the options given below.

- (1) A and D only
- (2) B and D only
- (3) A and E only
- (4) B and C only

**Answer (2)**

85. Which plot of  $\ln k$  vs  $\frac{1}{T}$  is consistent with Arrhenius equation?

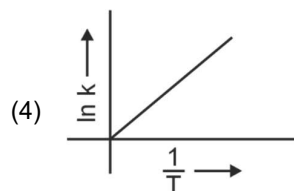
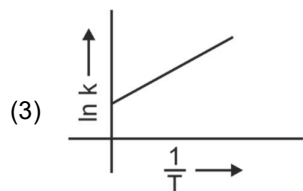
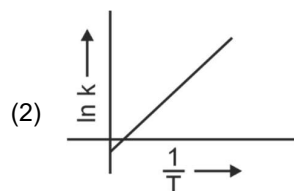
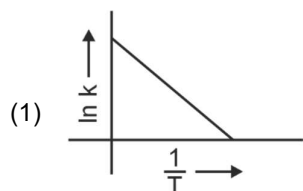

**Answer (1)**





96. For the given reaction:

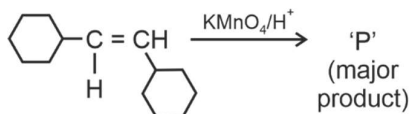

'P' is

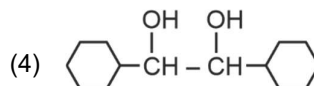
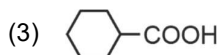
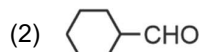
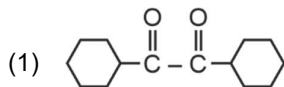

**Answer (3)**

97. During the preparation of Mohr's salt solution (Ferrous ammonium sulphate), which of the following acid is added to prevent hydrolysis of  $\text{Fe}^{2+}$  ion?

(1) dilute sulphuric acid

(2) dilute hydrochloric acid

(3) concentrated sulphuric acid

(4) dilute nitric acid

**Answer (1)**

98. The work done during reversible isothermal expansion of one mole of hydrogen gas at  $25^\circ\text{C}$  from pressure of 20 atmosphere to 10 atmosphere is

(Given  $R = 2.0 \text{ cal K}^{-1} \text{ mol}^{-1}$ )

(1) 100 calories

(2) 0 calorie

(3)  $-413.14$  calories

(4) 413.14 calories

**Answer (3)**

99. Given below are two statements :

**Statement I :**  $[\text{Co}(\text{NH}_3)_6]^{3+}$  is a homoleptic complex whereas  $[\text{Co}(\text{NH}_3)_4\text{Cl}_2]^+$  is a heteroleptic complex.

**Statement II :** Complex  $[\text{Co}(\text{NH}_3)_6]^{3+}$  has only one kind of ligands but  $[\text{Co}(\text{NH}_3)_4\text{Cl}_2]^+$  has more than one kind of ligands.

In the light of the above statements, choose the *correct* answer from the options given below.

(1) Statement I is false but Statement II is true

(2) Both Statement I and Statement II are true

(3) Both Statement I and Statement II are false

(4) Statement I is true but Statement II is false

**Answer (2)**

100. Mass in grams of copper deposited by passing 9.6487 A current through a voltmeter containing copper sulphate solution for 100 seconds is (Given : Molar mass of Cu :  $63 \text{ g mol}^{-1}$ ,  $1 \text{ F} = 96487 \text{ C}$ )

(1) 0.0315 g

(2) 3.15 g

(3) 0.315 g

(4) 31.5 g

**Answer (3)**

**BOTANY****SECTION-A**

101. Lecithin, a small molecular weight organic compound found in living tissues, is an example of:

- (1) Carbohydrates (2) Amino acids  
(3) Phospholipids (4) Glycerides

**Answer (3)**

102. These are regarded as major causes of biodiversity loss:

- A. Over exploitation  
B. Co-extinction  
C. Mutation  
D. Habitat loss and fragmentation  
E. Migration

Choose the correct option:

- (1) A, B and D only (2) A, C and D only  
(3) A, B, C and D only (4) A, B and E only

**Answer (1)**

103. In a plant, black seed color (BB/Bb) is dominant over white seed color (bb). In order to find out the genotype of the black seed plant, with which of the following genotype will you cross it?

- (1) BB/Bb (2) BB  
(3) bb (4) Bb

**Answer (3)**

104. A transcription unit in DNA is defined primarily by the three regions in DNA and these are with respect to upstream and down stream end;

- (1) Promotor, Structural gene, Terminator  
(2) Repressor, Operator gene, Structural gene  
(3) Structural gene, Transposons, Operator gene  
(4) Inducer, Repressor, Structural gene

**Answer (1)**

105. Identify the set of **correct** statements:

- A. The flowers of *Vallisneria* are colourful and produce nectar.  
B. The flowers of water lily are not pollinated by water.  
C. In most of water-pollinated species, the pollen grains are protected from wetting.  
D. Pollen grains of some hydrophytes are long and ribbon like.  
E. In some hydrophytes, the pollen grains are carried passively inside water.

Choose the correct answer from the options given below.

- (1) B, C, D and E only (2) C, D and E only  
(3) A, B, C and D only (4) A, C, D and E only

**Answer (1)**

106. Bulliform cells are responsible for
- (1) Providing large spaces for storage of sugars.
  - (2) Inward curling of leaves in monocots.
  - (3) Protecting the plant from salt stress.
  - (4) Increased photosynthesis in monocots.

**Answer (2)**

107. Match List I with List II

	List-I		List-II
A.	<i>Rhizopus</i>	I.	Mushroom
B.	<i>Ustilago</i>	II.	Smut fungus
C.	<i>Puccinia</i>	III.	Bread mould
D.	<i>Agaricus</i>	IV.	Rust fungus

Choose the correct answer from the options given below:

- (1) A-IV, B-III, C-II, D-I
- (2) A-III, B-II, C-IV, D-I
- (3) A-I, B-III, C-II, D-IV
- (4) A-III, B-II, C-I, D-IV

**Answer (2)**

108. Given below are two statements:

**Statement I :** Chromosomes become gradually visible under light microscope during leptotene stage.

**Statement II :** The beginning of diplotene stage is recognized by dissolution of synaptonemal complex.

In the light of the above statements, choose the correct answer from the options given below:

- (1) Statement I is false but Statement II is true
- (2) Both Statement I and Statement II are true
- (3) Both Statement I and Statement II are false
- (4) Statement I is true but Statement II is false

**Answer (2)**

109. Match List I with List II

List I	List II
A. <i>Clostridium butylicum</i>	I. Ethanol
B. <i>Saccharomyces cerevisiae</i>	II. Streptokinase
C. <i>Trichoderma polysporum</i>	III. Butyric acid
D. <i>Streptococcus sp.</i>	IV. Cyclosporin-A

Choose the correct answer from the options given below:

- (1) A-IV, B-I, C-III, D-II
- (2) A-III, B-I, C-II, D-IV
- (3) A-II, B-IV, C-III, D-I
- (4) A-III, B-I, C-IV, D-II

**Answer (4)**



110. The cofactor of the enzyme carboxypeptidase is:

- (1) Haem
- (2) Zinc
- (3) Niacin
- (4) Flavin

**Answer (2)**

111. Given below are two statements:

**Statement I** : Parenchyma is living but collenchyma is dead tissue.

**Statement II** : Gymnosperms lack xylem vessels but presence of xylem vessels is the characteristic of angiosperms.

In the light of the above statements, choose the correct answer from the options given below:

- (1) Statement I is false but Statement II is true
- (2) Both Statement I and Statement II are true
- (3) Both Statement I and Statement II are false
- (4) Statement I is true but Statement II is false

**Answer (1)**

112. Identify the type of flowers based on the position of calyx, corolla and androecium with respect to the ovary from the given figures (a) and (b)

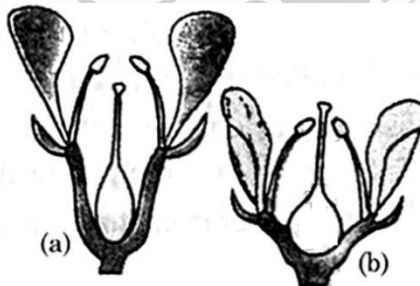

- (1) (a) Perigynous; (b) Perigynous
- (2) (a) Epigynous; (b) Hypogynous
- (3) (a) Hypogynous; (b) Epigynous
- (4) (a) Perigynous; (b) Epigynous

**Answer (1)**

113. The equation of Verhulst-Pearl logistic growth is  $\frac{dN}{dt} = rN \left[ \frac{K-N}{K} \right]$ .

From this equation, K indicates:

- (1) Population density
- (2) Intrinsic rate of natural increase
- (3) Biotic potential
- (4) Carrying capacity

**Answer (4)**

114. How many molecules of ATP and NADPH are required for every molecule of  $\text{CO}_2$  fixed in the Calvin cycle?
- (1) 3 molecules of ATP and 2 molecules of NADPH
  - (2) 2 molecules of ATP and 3 molecules of NADPH
  - (3) 2 molecules of ATP and 2 molecules of NADPH
  - (4) 3 molecules of ATP and 3 molecules of NADPH

**Answer (1)**

115. Which of the following are required for the dark reaction of photosynthesis?
- A. Light
  - B. Chlorophyll
  - C.  $\text{CO}_2$
  - D. ATP
  - E. NADPH

Choose the **correct** answer from the options given below:

- (1) D and E only
- (2) A, B and C only
- (3) B, C and D only
- (4) C, D and E only

**Answer (4)**

116. What is the fate of a piece of DNA carrying only gene of interest which is transferred into an alien organism?
- A. The piece of DNA would be able to multiply itself independently in the progeny cells of the organism.
  - B. It may get integrated into the genome of the recipient.
  - C. It may multiply and be inherited along with the host DNA.
  - D. The alien piece of DNA is not an integral part of chromosome.
  - E. It shows ability to replicate.

Choose the correct answer from the options given below:

- (1) A and E only
- (2) A and B only
- (3) D and E only
- (4) B and C only

**Answer (4)**

117. Formation of interfascicular cambium from fully developed parenchyma cells is an example for
- (1) Maturation
  - (2) Differentiation
  - (3) Redifferentiation
  - (4) Dedifferentiation

**Answer (4)**

118. The type of conservation in which the threatened species are taken out from their natural habitat and placed in special setting where they can be protected and given special care is called
- (1) Sustainable development
  - (2) *in-situ* conservation
  - (3) Biodiversity conservation
  - (4) Semi-conservative method

**Answer (3)**

119. Which of the following is an example of actinomorphic flower?
- (1) *Sesbania* (2) *Datura*  
(3) *Cassia* (4) *Pisum*

**Answer (2)**

120. The capacity to generate a whole plant from any cell of the plant is called:
- (1) Somatic hybridization (2) Totipotency  
(3) Micropropagation (4) Differentiation

**Answer (2)**

121. Which one of the following can be explained on the basis of Mendel's Law of Dominance?
- A. Out of one pair of factors one is dominant and the other is recessive.  
B. Alleles do not show any expression and both the characters appear as such in  $F_2$  generation.  
C. Factors occur in pairs in normal diploid plants.  
D. The discrete unit controlling a particular character is called factor.  
E. The expression of only one of the parental characters is found in a monohybrid cross.

Choose the correct answer from the options given below:

- (1) A, B, C, D and E  
(2) A, B and C only  
(3) A, C, D and E only  
(4) B, C and D only

**Answer (3)**

122. Spindle fibers attach to kinetochores of chromosomes during
- (1) Telophase  
(2) Prophase  
(3) Metaphase  
(4) Anaphase

**Answer (3)**

123. Inhibition of Succinic dehydrogenase enzyme by malonate is a classical example of:
- (1) Enzyme activation  
(2) Cofactor inhibition  
(3) Feedback inhibition  
(4) Competitive inhibition

**Answer (4)**

124. Hind II always cuts DNA molecules at a particular point called recognition sequence and it consists of:
- (1) 10 bp  
(2) 8 bp  
(3) 6 bp  
(4) 4 bp

**Answer (3)**

125. Given below are two statements:

**Statement I :** Bt toxins are insect group specific and coded by a gene *cry IAc*.

**Statement II :** Bt toxin exists as inactive protoxin in *B. thuringiensis*. However, after ingestion by the insect the inactive protoxin gets converted into active form due to acidic pH of the insect gut.

In the light of the above statements, choose the correct answer from the options given below:

- (1) Statement I is false but Statement II is true
- (2) Both Statement I and Statement II are true
- (3) Both Statement I and Statement II are false
- (4) Statement I is true but Statement II is false

**Answer (4)**

126. Match List I with List II

	List-I		List-II
A.	Nucleolus	I.	Site of formation of glycolipid
B.	Centriole	II.	Organization like the cartwheel
C.	Leucoplasts	III.	Site for active ribosomal RNA synthesis
D.	Golgi apparatus	IV.	For storing nutrients

Choose the correct answer from the options given below:

- (1) A-I, B-II, C-III, D-IV
- (2) A-III, B-II, C-IV, D-I
- (3) A-II, B-III, C-I, D-IV
- (4) A-III, B-IV, C-II, D-I

**Answer (2)**

127. A pink flowered Snapdragon plant was crossed with a red flowered Snapdragon plant. What type of phenotype/s is/are expected in the progeny?

- (1) Red, Pink as well as white flowered plants
- (2) Only red flowered plants
- (3) Red flowered as well as pink flowered plants
- (4) Only pink flowered plants

**Answer (3)**

128. List of endangered species was released by

- (1) IUCN
- (2) GEAC
- (3) WWF
- (4) FOAM

**Answer (1)**

129. Tropical regions show greatest level of species richness because
- Tropical latitudes have remained relatively undisturbed for millions of years, hence more time was available for species diversification.
  - Tropical environments are more seasonal.
  - More solar energy is available in tropics.
  - Constant environments promote niche specialization.
  - Tropical environments are constant and predictable.

Choose the correct answer from the options given below.

- |                     |                        |
|---------------------|------------------------|
| (1) A, B and D only | (2) A, C, D and E only |
| (3) A and B only    | (4) A, B and E only    |

**Answer (2)**

130. Which one of the following is not a criterion for classification of fungi?

- |                       |                             |
|-----------------------|-----------------------------|
| (1) Fruiting body     | (2) Morphology of mycelium  |
| (3) Mode of nutrition | (4) Mode of spore formation |

**Answer (3)**

131. Identify the part of the seed from the given figure which is destined to form root when the seed germinates.

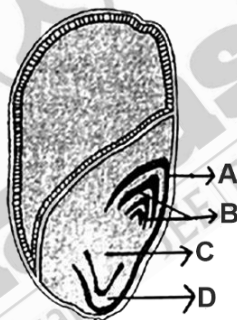

- |       |       |
|-------|-------|
| (1) D | (2) A |
| (3) B | (4) C |

**Answer (4)**

132. The lactose present in the growth medium of bacteria is transported to the cell by the action of

- |                |                        |
|----------------|------------------------|
| (1) Polymerase | (2) Beta-galactosidase |
| (3) Acetylase  | (4) Permease           |

**Answer (4)**

133. Auxin is used by gardeners to prepare weed-free lawns. But no damage is caused to grass as auxin

- can help in cell division in grasses, to produce growth.
- promotes apical dominance.
- promotes abscission of mature leaves only.
- does not affect mature monocotyledonous plants.

**Answer (4)**

134. In the given figure, which component has thin outer walls and highly thickened inner walls?

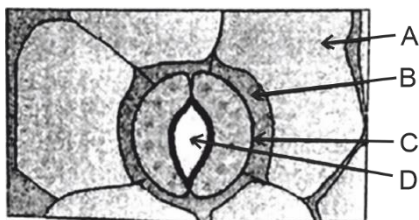

- (1) B (2) C  
(3) D (4) A

**Answer (2)**

135. Match List I with List II

- | List I  | List II        |
|---|----------------|
| A. Two or more alternative forms of a gene                          | I. Back cross  |
| B. Cross of F <sub>1</sub> progeny with homozygous recessive parent | II. Ploidy     |
| C. Cross of F <sub>1</sub> progeny with any of the parents          | III. Allele    |
| D. Number of chromosome sets in plant                               | IV. Test cross |

Choose the **correct** answer from the options given below:

- (1) A-IV, B-III, C-II, D-I (2) A-I, B-II, C-III, D-IV  
(3) A-II, B-I, C-III, D-IV (4) A-III, B-IV, C-I, D-II

**Answer (4)**

### SECTION-B

136. Match List I with List II

- | List I    | List II                   |
|-----------|---------------------------|
| A. Rose   | I. Twisted aestivation    |
| B. Pea    | II. Perigynous flower     |
| C. Cotton | III. Drupe                |
| D. Mango  | IV. Marginal placentation |

Choose the correct answer from the options given below :

- (1) A-II, B-III, C-IV, D-I (2) A-II, B-IV, C-I, D-III  
(3) A-I, B-II, C-III, D-IV (4) A-IV, B-III, C-II, D-I

**Answer (2)**

137. Given below are two statements:

**Statement I:** In C<sub>3</sub> plants, some O<sub>2</sub> binds to RuBisCO, hence CO<sub>2</sub> fixation is decreased.

**Statement II:** In C<sub>4</sub> plants, mesophyll cells show very little photorespiration while bundle sheath cells do not show photorespiration.

In the light of the above statements, choose the *correct* answer from the options given below:

- (1) Statement I is false but Statement II is true  
(2) Both Statement I and Statement II are true  
(3) Both Statement I and Statement II are false  
(4) Statement I is true but Statement II is false

**Answer (4)**

138. Identify the correct description about the given figure:

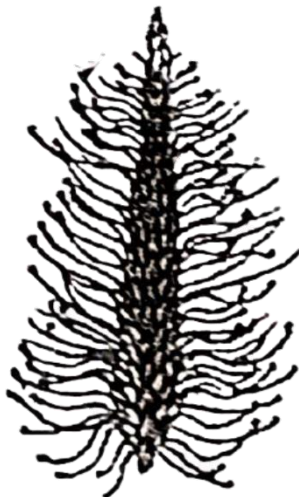

- (1) Compact inflorescence showing complete autogamy
- (2) Wind pollinated plant inflorescence showing flowers with well exposed stamens.
- (3) Water pollinated flowers showing stamens with mucilaginous covering.
- (4) Cleistogamous flowers showing autogamy.

**Answer (2)**

139. Read the following statements and choose the set of correct statements:

In the members of Phaeophyceae,

- A. Asexual reproduction occurs usually by biflagellate zoospores.
- B. Sexual reproduction is by oogamous method only.
- C. Stored food is in the form of carbohydrates which is either mannitol or laminarin.
- D. The major pigments found are chlorophyll a, c and carotenoids and xanthophyll.
- E. Vegetative cells have a cellulosic wall, usually covered on the outside by gelatinous coating of algin.

Choose the correct answer from the options given below:

- (1) A, B, C and E only
- (2) A, B, C and D only
- (3) B, C, D and E only
- (4) A, C, D and E only

**Answer (4)**

140. Identify the step in tricarboxylic acid cycle, which does not involve oxidation of substrate.

- (1) Isocitrate  $\rightarrow$   $\alpha$ -ketoglutaric acid
- (2) Malic acid  $\rightarrow$  Oxaloacetic acid
- (3) Succinic acid  $\rightarrow$  Malic acid
- (4) Succinyl-CoA  $\rightarrow$  Succinic acid

**Answer (4)**

141. Match List I with List II

**List I**

- A. Robert May
- B. Alexander von Humboldt
- C. Paul Ehrlich
- D. David Tilman

**List II**

- I. Species-Area relationship
- II. Long term ecosystem experiment using out door plots
- III. Global species diversity at about 7 million
- IV. Rivet popper hypothesis

Choose the correct answer from the options given below:

- (1) A-III, B-IV, C-II, D-I
- (2) A-II, B-III, C-I, D-IV
- (3) A-III, B-I, C-IV, D-II
- (4) A-I, B-III, C-II, D-IV

**Answer (3)**

142. Match List I with List II

**List I**

- A. Frederick Griffith
- B. Francois Jacob & Jacque Monod
- C. Har Gobind Khorana
- D. Meselson & Stahl

**List II**

- I. Genetic code
- II. Semi-conservative mode of DNA replication
- III. Transformation
- IV. *Lac* operon

Choose the correct answer from the options given below:

- (1) A-IV, B-I, C-II, D-III
- (2) A-III, B-II, C-I, D-IV
- (3) A-III, B-IV, C-I, D-II
- (4) A-II, B-III, C-IV, D-I

**Answer (3)**

143. Which of the following are fused in somatic hybridization involving two varieties of plants?

- (1) Pollens
- (2) Callus
- (3) Somatic embryos
- (4) Protoplasts

**Answer (4)**

144. The DNA present in chloroplast is:

- (1) Circular, single stranded
- (2) Linear, double stranded
- (3) Circular, double stranded
- (4) Linear, single stranded

**Answer (3)**

145. Match List I with List II

**List I**

**(Types of Stamens)**

- A. Monoadelphous
- B. Diadelphous
- C. Polyadelphous
- D. Epiphyllous

**List II**

**(Example)**

- I. Citrus
- II. Pea
- III. Lily
- IV. China-rose

Choose the correct answer from the options given below:

- (1) A-III, B-I, C-IV, D-II
- (2) A-IV, B-II, C-I, D-III
- (3) A-IV, B-I, C-II, D-III
- (4) A-I, B-II, C-IV, D-III

**Answer (2)**



146. Which of the following statement is correct regarding the process of replication in *E.coli*?
- (1) The DNA dependent DNA polymerase catalyses polymerization in 5' → 3' direction
  - (2) The DNA dependent DNA polymerase catalyses polymerization in one direction that is 3' → 5'
  - (3) The DNA dependent RNA polymerase catalyses polymerization in one direction, that is 5' → 3'
  - (4) The DNA dependent DNA polymerase catalyses polymerization in 5' → 3' as well as 3' → 5' direction

**Answer (1)**

147. In an ecosystem if the Net Primary Productivity (NPP) of first trophic level is  $100x$  ( $\text{kcal m}^{-2}$ )  $\text{yr}^{-1}$ , what would be the GPP (Gross Primary Productivity) of the third trophic level of the same ecosystem?

- (1)  $\frac{100x}{3x}$  ( $\text{kcal m}^{-2}$ )  $\text{yr}^{-1}$
- (2)  $\frac{x}{10}$  ( $\text{kcal m}^{-2}$ )  $\text{yr}^{-1}$
- (3)  $x$  ( $\text{kcal m}^{-2}$ )  $\text{yr}^{-1}$
- (4)  $10x$  ( $\text{kcal m}^{-2}$ )  $\text{yr}^{-1}$

**Answer (4)**

148. Match **List-I** with **List-II**

**List-I**

- A. GLUT-4
- B. Insulin
- C. Trypsin
- D. Collagen

**List-II**

- I. Hormone
- II. Enzyme
- III. Intercellular ground substance
- IV. Enables glucose transport into cells

Choose the correct answer from the options given below.

- (1) A-III, B-IV, C-I, D-II
- (2) A-IV, B-I, C-II, D-III
- (3) A-I, B-II, C-III, D-IV
- (4) A-II, B-III, C-IV, D-I

**Answer (2)**

149. Match List I with List II

	<b>List I</b>		<b>List II</b>
A.	Citric acid cycle	I.	Cytoplasm
B.	Glycolysis	II.	Mitochondrial matrix
C.	Electron transport system	III.	Intermembrane space of mitochondria
D.	Proton gradient	IV.	Inner mitochondrial membrane

Choose the correct answer from the options given below:

- (1) A-IV, B-III, C-II, D-I
- (2) A-I, B-II, C-III, D-IV
- (3) A-II, B-I, C-IV, D-III
- (4) A-III, B-IV, C-I, D-II

**Answer (3)**

150. Spraying sugarcane crop with which of the following plant growth regulators, increases the length of stem, thus, increasing the yield?

- (1) Abscisic acid
- (2) Auxin
- (3) Gibberellin
- (4) Cytokinin

**Answer (3)**

**ZOOLOGY**

**SECTION-A**

151. Which of the following factors are favourable for the formation of oxyhaemoglobin in alveoli?

- (1) Low  $p\text{CO}_2$  and High temperature
- (2) High  $p\text{O}_2$  and High  $p\text{CO}_2$
- (3) High  $p\text{O}_2$  and Lesser  $\text{H}^+$  concentration
- (4) Low  $p\text{CO}_2$  and High  $\text{H}^+$  concentration

**Answer (3)**

152. Following are the stages of cell division :

- A. Gap 2 phase
- B. Cytokinesis
- C. Synthesis phase
- D. Karyokinesis
- E. Gap 1 phase

Choose the correct sequence of stages from the options given below :

- (1) E-C-A-D-B
- (2) C-E-D-A-B
- (3) E-B-D-A-C
- (4) B-D-E-A-C

**Answer (1)**

153. In both sexes of cockroach, a pair of jointed filamentous structures called anal cerci are present on

- (1) 11<sup>th</sup> segment
- (2) 5<sup>th</sup> segment
- (3) 10<sup>th</sup> segment
- (4) 8<sup>th</sup> and 9<sup>th</sup> segment

**Answer (3)**

154. Match List I with List II :

	List I		List II
A.	Pleurobrachia	I.	Mollusca
B.	Radula	II.	Ctenophora
C.	Stomochord	III.	Osteichthyes
D.	Air bladder	IV.	Hemichordata

Choose the correct answer from the options given below :

- (1) A-IV, B-III, C-II, D-I
- (2) A-IV, B-II, C-III, D-I
- (3) A-II, B-I, C-IV, D-III
- (4) A-II, B-IV, C-I, D-III

**Answer (3)**







167. Match List I with List II :

	List I		List II
A.	Down's syndrome	I.	11 <sup>th</sup> chromosome
B.	$\alpha$ -Thalassemia	II.	'X' chromosome
C.	$\beta$ -Thalassemia	III.	21 <sup>st</sup> chromosome
D.	Klinefelter's syndrome	IV.	16 <sup>th</sup> chromosome

Choose the correct answer from the options given below :

- (1) A-IV, B-I, C-II, D-III
- (2) A-I, B-II, C-III, D-IV
- (3) A-II, B-III, C-IV, D-I
- (4) A-III, B-IV, C-I, D-II

**Answer (4)**

168. Given below are two statements: One is labelled as Assertion A and the other is labelled as Reason R:

**Assertion A** : Breast-feeding during initial period of infant growth is recommended by doctors for bringing a healthy baby.

**Reason R** : Colostrum contains several antibodies absolutely essential to develop resistance for the new born baby.

In the light of the above statements, choose the most appropriate answer from the options given below:

- (1) A is not correct but R is correct
- (2) Both A and R are correct and R is the correct explanation of A
- (3) Both A and R are correct but R is NOT the correct explanation of A
- (4) A is correct but R is not correct

**Answer (2)**

169. Match List I with List II :

	List I		List II
A.	Expiratory capacity	I.	Expiratory reserve volume + Tidal volume + Inspiratory reserve volume
B.	Functional residual capacity	II.	Tidal volume + Expiratory reserve volume
C.	Vital capacity	III.	Tidal volume + Inspiratory reserve volume
D.	Inspiratory capacity	IV.	Expiratory reserve volume + Residual volume

Choose the correct answer from the options given below :

- (1) A-I, B-III, C-II, D-IV
- (2) A-II, B-IV, C-I, D-III
- (3) A-III, B-II, C-IV, D-I
- (4) A-II, B-I, C-IV, D-III

**Answer (2)**



174. Consider the following statements :

- A. Annelids are true coelomates
- B. Poriferans are pseudocoelomates
- C. Aschelminthes are acoelomates
- D. Platyhelminthes are pseudocoelomates

Choose the correct answer from the options given below :

- (1) D only
- (2) B only
- (3) A only
- (4) C only

**Answer (3)**

175. Which one is the correct product of DNA dependent RNA polymerase to the given template?

3'TACATGGCAAATATCCATTCA5'

- (1) 5'ATGTACCGTTTATAGGTAAGT3'
- (2) 5'AUGUACCGUUUUAUAGGUAAGU3'
- (3) 5'AUGUAAAGUUUUAUAGGUAAGU3'
- (4) 5'AUGUACCGUUUUAUAGGGAAGU3'

**Answer (2)**

176. Which one of the following factors will not affect the Hardy-Weinberg equilibrium?

- (1) Constant gene pool
- (2) Genetic recombination
- (3) Genetic drift
- (4) Gene migration

**Answer (1)**

177. The "Ti plasmid" of *Agrobacterium tumefaciens* stands for

- (1) Temperature independent plasmid
- (2) Tumour inhibiting plasmid
- (3) Tumor independent plasmid
- (4) Tumor inducing plasmid

**Answer (4)**

178. Given below are two statements :

**Statement I :** In the nephron, the descending limb of loop of Henle is impermeable to water and permeable to electrolytes.

**Statement II :** The proximal convoluted tubule is lined by simple columnar brush border epithelium and increases the surface area for reabsorption.

In the light of the above statements, choose the correct answer from the option given below :

- (1) Statement I is false but Statement II is true
- (2) Both Statement I and Statement II are true
- (3) Both Statement I and Statement II are false
- (4) Statement I is true but Statement II is false

**Answer (3)**





183. The following diagram showing restriction sites in *E. coli* cloning vector pBR322. Find the role of 'X' and 'Y' genes :

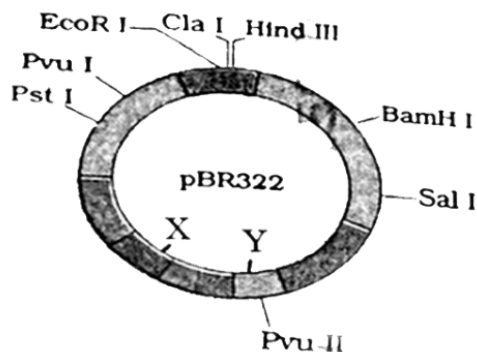

- (1) Gene 'X' is responsible for recognitions sites and 'Y' is responsible for antibiotic resistance.
- (2) The gene 'X' is responsible for resistance to antibiotics and 'Y' for protein involved in the replication of Plasmid.
- (3) The gene 'X' is responsible for controlling the copy number of the linked DNA and 'Y' for protein involved in the replication of Plasmid.
- (4) The gene 'X' is for protein involved in replication of Plasmid and 'Y' for resistance to antibiotics.

**Answer (3)**

184. Match List I with List II :

**List I**

- A. Common cold
- B. Haemozoin
- C. Widal test
- D. Allergy

**List II**

- I. *Plasmodium*
- II. Typhoid
- III. Rhinoviruses
- IV. Dust mites

Choose the correct answer from the options given below :

- (1) A-IV, B-II, C-III, D-I
- (2) A-II, B-IV, C-III, D-I
- (3) A-I, B-III, C-II, D-IV
- (4) A-III, B-I, C-II, D-IV

**Answer (4)**

185. Match List I with List II :

**List I**

- A. Axoneme
- B. Cartwheel pattern
- C. Crista
- D. Satellite

**List II**

- I. Centriole
- II. Cilia and flagella
- III. Chromosome
- IV. Mitochondria

Choose the correct answer from the options given below :

- (1) A-II, B-I, C-IV, D-III
- (2) A-IV, B-III, C-II, D-I
- (3) A-IV, B-II, C-III, D-I
- (4) A-II, B-IV, C-I, D-III

**Answer (1)**

## SECTION-B

186. The following are the statements about non-chordates:

- A. Pharynx is perforated by gill slits.
- B. Notochord is absent.
- C. Central nervous system is dorsal.
- D. Heart is dorsal if present.
- E. Post anal tail is absent.

Choose the most appropriate answer from the options given below:

- (1) B, C & D only
- (2) A & C only
- (3) A, B & D only
- (4) B, D & E only

**Answer (4)**

187. As per ABO blood grouping system, the blood group of father is B<sup>+</sup>, mother is A<sup>+</sup> and child is O<sup>+</sup>. Their respective genotype can be

- A. I<sup>B</sup>i/I<sup>A</sup>i/ii
- B. I<sup>B</sup>I<sup>B</sup>/I<sup>A</sup>I<sup>A</sup>/ii
- C. I<sup>A</sup>I<sup>B</sup>/ii/I<sup>A</sup>/I<sup>B</sup>i
- D. I<sup>A</sup>i/I<sup>B</sup>i/I<sup>A</sup>i
- E. ii/I<sup>B</sup>/I<sup>A</sup>/I<sup>A</sup>I<sup>B</sup>

Choose the most appropriate answer from the options given below :

- (1) D & E only
- (2) A only
- (3) B only
- (4) C & B only

**Answer (2)**

188. Match List I with List II:

	List I		List II
A.	Mesozoic Era	I.	Lower invertebrates
B.	Proterozoic Era	II.	Fish & Amphibia
C.	Cenozoic Era	III.	Birds & Reptiles
D.	Paleozoic Era	IV.	Mammals

Choose the correct answer from the options given below :

- (1) A-III, B-I, C-IV, D-II
- (2) A-II, B-I, C-III, D-IV
- (3) A-III, B-I, C-II, D-IV
- (4) A-I, B-II, C-IV, D-III

**Answer (1)**

189. Match List I with List II :

	List I		List II
A.	P wave	I.	Heart muscles are electrically silent.
B.	QRS complex	II.	Depolarisation of ventricles.
C.	T wave	III.	Depolarisation of atria.
D.	T-P gap	IV.	Repolarisation of ventricles.

Choose the correct answer from the options given below :

- (1) A-IV, B-II, C-I, D-III
- (2) A-I, B-III, C-IV, D-II
- (3) A-III, B-II, C-IV, D-I
- (4) A-II, B-III, C-I, D-IV

**Answer (3)**



194. Choose the correct statement given below regarding juxta medullary nephron.
- (1) Juxta medullary nephrons outnumber the cortical nephrons.
  - (2) Juxta medullary nephrons are located in the columns of Bertini.
  - (3) Renal corpuscle of juxta medullary nephron lies in the outer portion of the renal medulla.
  - (4) Loop of Henle of juxta medullary nephron runs deep into medulla.

**Answer (4)**

195. Given below are two statements :

**Statement I :** Bone marrow is the main lymphoid organ where all blood cells including lymphocytes are produced.

**Statement II :** Both bone marrow and thymus provide micro environments for the development and maturation of T-lymphocytes.

In the light of above statements, choose the most appropriate answer from the options given below :

- (1) Statement I is incorrect but Statement II is correct.
- (2) Both Statement I and Statement II are correct.
- (3) Both Statement I and Statement II are incorrect.
- (4) Statement I is correct but Statement II is incorrect.

**Answer (2)**

196. Match List I with List II related to digestive system of cockroach.

	List I		List II
A.	The structures used for storing of food	I.	Gizzard
B.	Ring of 6-8 blind tubules at junction of foregut and midgut.	II.	Gastric Caeca
C.	Ring of 100-150 yellow coloured thin filaments at junction of midgut and hindgut.	III.	Malpighian tubules
D.	The structures used for grinding the food.	IV.	Crop

Choose the correct answer from the options given below:

- (1) A-III, B-II, C-IV, D-I
- (2) A-IV, B-II, C-III, D-I
- (3) A-I, B-II, C-III, D-IV
- (4) A-IV, B-III, C-II, D-I

**Answer (2)**

197. Given below are two statements:

**Statement I:** The cerebral hemispheres are connected by nerve tract known as corpus callosum.

**Statement II:** The brain stem consists of the medulla oblongata, pons and cerebrum.

In the light of the above statements, choose the most appropriate answer from the options given below:

- (1) Statement I is incorrect but Statement II is correct.
- (2) Both Statement I and Statement II are correct.
- (3) Both Statement I and Statement II are incorrect.
- (4) Statement I is correct but Statement II is incorrect.

**Answer (4)**

198. Given below are two statements:

**Statement I:** Gause's competitive exclusion principle states that two closely related species competing for different resources cannot exist indefinitely.

**Statement II:** According to Gause's principle, during competition, the inferior will be eliminated. This may be true if resources are limiting.

In the light of the above statements, choose the correct answer from the options given below :

- (1) Statement I is false but Statement II is true.
- (2) Both Statement I and Statement II are true.
- (3) Both Statement I and Statement II are false.
- (4) Statement I is true but Statement II is false.

**Answer (1)**

199. Match List I with List II:

	List I		List II
A.	RNA polymerase III	I.	snRNPs
B.	Termination of transcription	II.	Promotor
C.	Splicing of Exons	III.	Rho factor
D.	TATA box	IV.	SnRNAs, tRNA

Choose the correct answer from the options given below :

- (1) A-IV, B-III, C-I, D-II
- (2) A-II, B-IV, C-I, D-III
- (3) A-III, B-II, C-IV, D-I
- (4) A-III, B-IV, C-I, D-II

**Answer (1)**

200. Identify the correct option (A), (B), (C), (D) with respect to spermatogenesis.

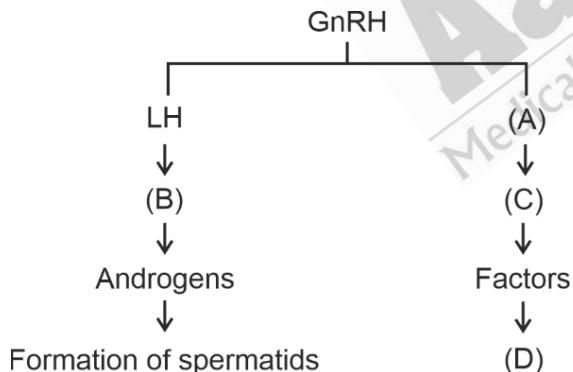

- (1) ICSH, Leydig cells, Sertoli cells, spermatogenesis.
- (2) FSH, Leydig cells, Sertoli cells, spermiogenesis.
- (3) ICSH, Interstitial cells, Leydig cells, spermiogenesis.
- (4) FSH, Sertoli cells, Leydig cells, spermatogenesis.

**Answer (2)**

