

cracku 

All rights reserved. No part of this publication may be reproduced, distributed, or transmitted in any form or by any means, electronic, mechanical, photocopying, recording or otherwise, or stored in any retrieval system of any nature without the permission of cracku.in, application for which shall be made to support@cracku.in

TISSNET 2018

General Awareness

1. Which one of the following objectives is NOT embodied in the Preamble to the Constitution of India?

- A Liberty of thought
- B Liberty of movement
- C Liberty of belief
- D Liberty of expression

Answer: B

Download IIFT Previous papers PDF

2. The Radcliffe Committee was appointed to _____.

- A draw the boundaries between India and Pakistan
- B give effect to the Independence Bill
- C solve the problems of minorities in India
- D enquire into the riots in East Bengal

Answer: A

3. Who, in India, has the power to summon or prorogue either House of the Parliament?

- A President
- B Home Minister
- C Prime Minister
- D Vice President

Answer: A

4. The Indian Supreme Court's judgement on triple talaq refers to which of its forms?

- A Talaq-e-Ahsan
- B Talaq-e-Hasan
- C Talaq-e-Biddat
- D All of the above

Answer: C

XAT Previous Papers

5. The number '1729' is considered as an interesting number as it is the smallest natural number that can be written as the sum of cubes in two ways - sum of the cubes of 12 and 1 and the sum of the cubes of 10 and 9. What is this number '1729' popularly known as?

- A Landau-Ramanujan Constant
- B Hardy-Ramanujan Number
- C Ramanujan-Soldner Number
- D None of the above

Answer: B

6. The key document that legally entitles registered households to apply for work under MGNREGA is _____.

- A Aadhar Card
- B Ration Card
- C PAN Card
- D Job card

Answer: D

7. "Halfway to Heaven" is the slogan adopted to promote tourism by which Indian state?

- A Meghalaya
- B Jammu and Kashmir
- C Sikkim
- D Uttarakhand

Answer: A

CMAT Free Solved Previous Papers.

8. 'Adam's Apple' is the common name for which organ in the human body?

- A Esophagus
- B Thyroid cartilage
- C Thoracic cavity
- D Phalange

Answer: B

9. Which tribal community in Madhya Pradesh celebrates the Bhagoria festival?

- A Bhil
- B Gond
- C Mariya
- D Bhariya

Answer: A

10. In February 2017, ISRO launched PSLV-C37 which carried 104 satellites belonging to seven countries, including India. How many of these were Indian satellites?

- A 96
- B 3
- C 1
- D 4

Answer: B

MAT Free Solved Previous Papers

11. Who has authored the book 'The Remembered Village'?

- A M.N. Srinivas
- B Iravati Karve
- C T.N. Madan
- D G.S. Ghurye

Answer: A

12. The recipient of the Nobel Prize for Economics in the year 2017 contributed to which field of research?

- A Macroeconomic theory
- B Development Economics
- C Behavioural Economics
- D All of the above

Answer: C

13. The first Census of independent India was conducted in the year_____.

- A 1950
- B 1951
- C 1949
- D 1948

Answer: B

Take 3 Free CAT Mocks (With Solutions)

14. Which indicator(s) is/are used by the International Food Policy Research Institute to compute the 'Global Hunger Index Report'?

- A Undernourishment
- B Child stunting

- C Child mortality
- D All of the above

Answer: D

15. For which of the following parameters does the Census of India NOT collect data?

- A Household size
- B Household ownership status
- C Income
- D Occupation

Answer: C

16. Which men's single title did badminton player Kidambi Srikanth win in 2017?

- A Badminton World Championship
- B All England Open Badminton Championship
- C French Open Superseries Badminton
- D Dubai World Superseries

Answer: C

XAT Free Mock Test

17. The control of a significant share of the supply or production of a particular good or service by a firm is called _____.

- A crony capitalism
- B monopsony
- C monopoly
- D None of the above

Answer: C

18. Tenali Raman was to _____ as Birbal was to Akbar.

- A Raghunatha Nayak
- B Krishna Deva Raya
- C Krishnaraj Wodiyar
- D Mahendra Varman

Answer: B

19. Consider the following three statements and indicate which of these is/are CORRECT

- i) Sex is a biological concept; Gender is a social construct
- ii) Sex is a natural or biological feature; Gender is a cultural or learned feature
- iii) Both terms mean the same and can be used interchangeably

- A (i) and (ii)
- B Only (ii)
- C (i) and (iii)
- D Only (iii)

Answer: A

Download IIFT Previous Papers PDF

20. Vishaka Guidelines are a set of procedural guidelines that apply to which type of criminal cases?

- A Paedophilia
- B Dowry deaths
- C Human Trafficking
- D Sexual harassment of women at workplace

Answer: D

21. Pradhan Mantri Jan Dhan Yojana has been launched for _____.

- A providing housing loan to poor people at cheaper interest rates
- B providing financial help to small enterprises in rural areas
- C promoting financial inclusion in the country
- D promoting women's self help groups in backward areas

Answer: C

22. In which Indian city is the world's first solar powered airport located?

- A Delhi
- B Udaipur
- C Jaipur
- D Kochi

Answer: D

CAT Previous Papers PDF

23. Which of the following sports involves animals?

- A Jallikattu
- B Mallakhamb
- C Lagori

D Vallamkali

Answer: A

24. The 'Apu Trilogy' was directed by _____.

A Bimal Roy

B Ritwik Ghatak

C Satyajit Ray

D Mrinal Sen

Answer: C

25. The Padmapani and Vajrapani paintings are found in which caves in India?

A Elephanta Caves, Maharashtra

B Udayagiri Caves, Odissa

C Badami Caves, Karnataka

D Ajanta Caves, Maharashtra

Answer: D

XAT Previous Papers PDF

26. The word 'Zeta' refers to

A a letter in the Greek alphabet

B a national currency

C a mathematical symbol

D the name of a galaxy

Answer: A

27. 'Rashtriya Garima Abhiyaan' is a national campaign to _____.

A rehabilitate the homeless and destitute persons and provide them with shelter and livelihood opportunities.

B free bonded labourers of their bondage and rehabilitate them

C rehabilitate sex workers through alternative sources of livelihood

D eradicate the practice of manual scavenging and rehabilitate manual scavengers

Answer: D

28. The United States of America declared its withdrawal from the Paris Agreement in 2017. What was the stated reason for their withdrawal?

A Unfair benefits to India and China due to the Agreement

- B** Loss of its status within the United Nations to India and China
- C** Non-inclusion of India and China in the Agreement
- D** Lack of penalties for India and China in the Agreement

Answer: A

Top-500 Free CAT Questions (With Solutions)

29. Find the odd one out.

- A** Punam Raut
- B** Harmanpreet Kaur
- C** Mitali Raj
- D** Anjum Chopra

Answer: D

30. Considering the chronological order, identify the social media site that is the NEWEST among those given here.

- A** Instagram
- B** Twitter
- C** Facebook
- D** Snapchat

Answer: D

31. 'Pledge for 9' is the slogan for which national programme?

- A** Janani Suraksha Yojana
- B** Beti Bachao, Beti Padhao Yojana
- C** Pradhan Mantri Surakshit Matritva Abhiyan
- D** Janani Shishu Suraksha Karyakram

Answer: C

Take a XAT Free Mock Test

32. According to the 2011 Population Census, which of the following groups of states occupies the THREE top places with respect to literacy?

- A** Kerala, Lakshadweep, Mizoram
- B** Kerala, Chandigarh, Goa
- C** Kerala, Mizoram, Tripura
- D** Kerala, Goa, West Bengal

Answer: A

33. Who was awarded the Jnanpith award in 2017?

- A Shankha Ghosh
- B Bhalchandra Nemade
- C Amarkant
- D Krishna Sobti

Answer: D

34. Who first deciphered the edicts or inscriptions of Emperor Ashoka?

- A Georg Bihler
- B William Jones
- C Max Mueller
- D James Prinsep

Answer: D

Take a CMAT free mock test

35. According to the WHO 2017 Report maximum number of Indians suffer from _____.

- A depressive disorders
- B drug use disorders
- C schizophrenia
- D anxiety disorders

Answer: A

36. Match List I (Book) and List II (Author) and select the correct answers using the codes given below:

List I(Books)	List II(Authors)
a. In Custody	(i) Amartya Sen
b. Sea of Poppies	(ii) Jhumpa Lahiri
c. The Argumentative Indian	(iii) Anita Desai
d. Unaccustomed Earth	(iv) Amitav Ghosh

- A a-iii, b-iv, c-i, d-ii
- B a-iv, b-i, c-ii, d-iii
- C a-i, b-iii, c-iv, d-ii
- D a-iv, b-iii, c-ii, d-i

Answer: A

37. Which of the following represents billion bytes?

- A Gigabytes
- B Megabytes
- C Kilobytes
- D Terabytes

Answer: A

Take a free SNAP mock test

38. A low sex ratio in a particular place can indicate _____.

- A practice of significant sex selective foeticide
- B high male in-migration
- C Both of the above
- D None of the above

Answer: C

39. Which international body benchmarks countries on the 'Global Gender Gap Index'?

- A World Economic Forum
- B UN Women
- C The World Bank
- D World Health Organisation

Answer: A

40. One of the ways in which the National Food Security Act empowers women is by _____.

- A allocation of 10 kg extra food grain for women headed households
- B issue of ration card in the name of the eldest woman in eligible households
- C issuing separate ration cards for all women in eligible households with dependent children
- D None of the above

Answer: B

Take a NMAT free mock test

Maths & Logical Reasoning

41. Which of the following dates fall on the same day of the week in any given month?

- A 4 and 24
- B 6 and 30

C 13 and 27

D 11 and 22

Answer: C

Explanation:

If the difference between any two dates is multiple of 7, then those two fall on same day of the week in any given month. Thus, 13 and 27 fall on same day.

=> Ans - (C)

Download IIFT Previous papers PDF

42. If 15 August 1905 was a Tuesday, which day was 15 August in 1895?

A Friday

B Wednesday

C Thursday

D Tuesday

Answer: C

Explanation:

Number of odd days between 15 Aug 1895 to 31 Dec 1895 = $16 + 2 + 3 + 2 + 3 = 26$

Number of odd days between 01 Jan 1896 and 31 Dec 1904 = $2 + 1 + 1 + 1 + 1 + 1 + 1 + 1 + 2 = 11$

Number of odd days between 01 Jan 1905 to 15 August 1905 = $3 + 0 + 3 + 2 + 3 + 2 + 3 + 15 = 31$

=> Total odd days = $(26 + 11 + 31) \% 7 = 5$

So, the 15th August 1895 is a Thursday

43. The following table gives the percentage distribution of population of five states, P, Q, R, S and T on the basis of poverty line and gender. If the male population above poverty line for state R is 1.9 million, then the total population of state R is?

State	Percentage of Population below the Poverty Line	Proportion of Males and Females	
		Below Poverty Line	Above Poverty Line
		M : F	M : F
P	35	5 : 6	6 : 7
Q	25	3 : 5	4 : 5
R	24	1 : 2	2 : 3
S	19	3 : 2	4 : 3
T	15	5 : 3	3 : 2

A 6.25 million

B 5.35 million

C 4.5 million

D 4.85 million

Answer: A

Explanation:

Let total population of state R = $100x$ million

% of people below poverty line in state R = $24x$ and above poverty line = $76x$

Males above poverty line = $\frac{2}{5} \times 76x = 1.9$

$\Rightarrow x = \frac{0.5}{8} = 0.0625$

\therefore Total population of state R = **6.25 million**

\Rightarrow Ans - (A)

44. The figures given here show three distributions. Based on these figures, which of the following statements is FALSE?

Distribution-1

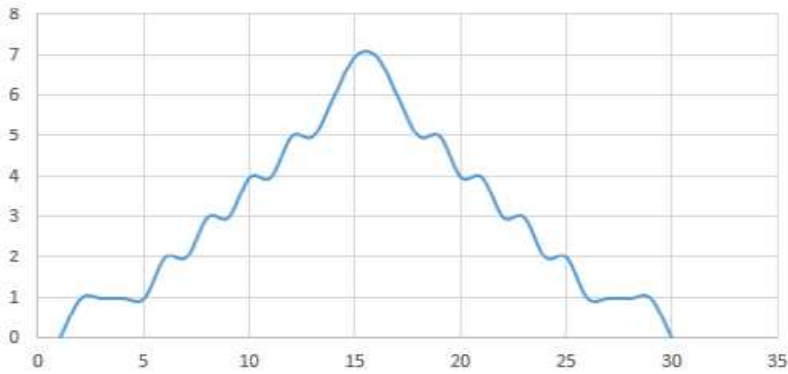

Distribution-2

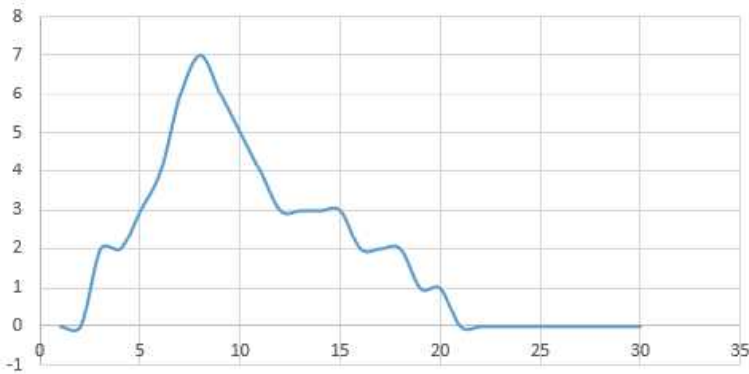

Distribution - 3

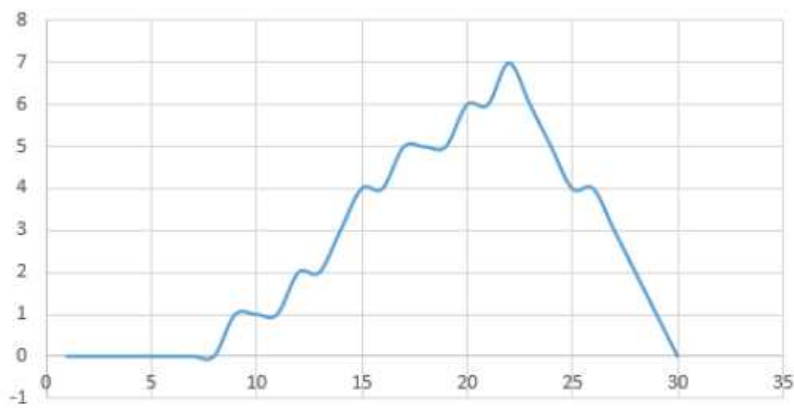

- A In Distribution-1, Mean=Median
- B In Distribution-3, Mean>Median
- C In Distribution-2, Mean
- D Mean for Distribution-2 > Mean for Distribution-3

Answer: D

Explanation:

For distribution- 2 we can see that the graph is concentrated on the left side and for distribution- 3 the graph is concentrated on the right side. So, mean of distribution- 2 is less than the mean of distribution- 3. Therefore, option D is false.

XAT Previous Papers

45. How many times do the hands of a clock overlap in 24 hours?

- A 11
- B 22
- C 24
- D 12

Answer: B

Explanation:

The hands of a clock coincide 11 times in every 12 hours (Since between 11 and 1, they coincide only once, i.e., at 12 o'clock). The hands overlap about every 65 minutes, not every 60 minutes. Thus the minute hand and the hour hand coincide 22 times in a day.

Thus, the hands of a clock overlap 22 times a day. Thus the hands of the clock overlap at 12:00, ~1:05, ~2:10, ~3:15, ~4:20, ~5:25, ~6:30, ~7:35, ~8:40, ~9:45, ~10:50. Note that there is no ~11:55. This becomes 12:00.

=> Ans - (B)

46. If $\tan(A) = 0$ and $\sin(A) = 0$. what is the value of $\cos(A)$?

- A Inf
- B 1
- C 0
- D Undefined

Answer: B

Explanation:

If $\tan(A) = 0$ and $\sin(A) = 0$

=> $\angle A = 0^\circ$

$\therefore \cos(A) = \cos(0^\circ) = 1$

=> Ans - (B)

47. 1 ml. salt is added to 19 ml. of distilled water. What is the percentage of salt in the dilution?

- A 10%
- B 5%
- C 4%
- D 0.05%

Answer: B

Explanation:

% of salt in the solution = $\frac{1}{(1+19)} \times 100$

= $\frac{100}{20} = 5\%$

=> Ans - (B)

CMAT Free Solved Previous Papers.

48. Which number should come next in the following series:

4, 12, 28, 52, _____

- A 92
- B 84
- C 108
- D None of the above

Answer: B

Explanation:

The pattern followed is that consecutive multiples of 8 are added.

$$4 + 8 = 12$$

$$12 + 16 = 28$$

$$28 + 24 = 52$$

$$52 + 32 = \mathbf{84}$$

=> Ans - (B)

49. Of the given FOUR sets of five numbers each, find the ODD ONE out.

- A 1, 2, 19, 23, 11
- B 841, 169, 9, 361, 4
- C 23, 29, 7, 5, 27
- D 1, 121, 169, 289, 25

Answer: C

Explanation:

The first series is a set of prime numbers, second and fourth are squares of prime numbers, hence third series is the odd one.

=> Ans - (C)

50. For a series of 5 numbers, the mean is 20, the median and mode are both 10, the highest number in the series is 50 and one of the numbers is 20. Find the number of times the modal value appears in the series.

- A 4
- B 1
- C 2
- D 3

Answer: D

Explanation:

If we arrange the five numbers in ascending order, median is 10, and fifth number is 50, thus series : x, y, 10, z, 50

Also, mean is 20, => $\frac{x+y+10+z+50}{5} = 20$

=> $x + y + z = 100 - 60 = 40$

Now, mode is 10, Case 1 : If $x = 10$, then we can have $y = z = 15$, and thus 10 cannot be mode.

Case 2 : If $x = y = 10$, thus $z = 20$, and mode is 10

Thus, modal value appears **3 times**.

=> Ans - (D)

MAT Free Solved Previous Papers

51. From the data given in the table, which of the following two statements is TRUE:

- 1) Average annual temperatures for year 2011 are more than average annual temperatures for years 2013.
- 2) Average annual temperatures for year 2010 are more than average annual temperatures for years 2012.

Average Monthly Temperatures in Degree C				
	January	April	July	October
2010	14	32	24	28
2011	12	30	22	30
2012	16	32	24	32
2013	16	34	24	30

- A Both statements are true
- B Statement 1 is false but Statement 2 is true
- C Statement 1 is true but Statement 2 is false
- D Both statements are false

Answer: D

Explanation:

Statement 1):

Average annual temperature in year 2011 = $(12 + 30 + 22 + 30)/4 = 23.5$

Average annual temperature in year 2013 = $(16 + 32 + 24 + 32)/4 = 26$

Average annual temperature in year 2011 < Average annual temperature in year 2013

Statement 1) is False.

Statement 2):

Average annual temperature in year 2010 = $(14 + 32 + 24 + 28)/4 = 24.5$

Average annual temperature in year 2012 = $(16 + 34 + 24 + 30)/4 = 26$

Average annual temperature in year 2010 < Average annual temperature in year 2012

Statement 2) is false.

52. Find the odd one out from the following list of numbers:

161, 203, 104, 112, 91

- A 91
- B 104
- C 112
- D None of the above

Answer: B

Explanation:

All the numbers except 104 are divisible by 7.

53. Mohit was looking for his father. He went 90 meters to the East before turning to his right. He went 20 meters before turning to his right again to look for his father in his uncle's house 30 meters away from this point. His father was not there. From here he went 100 meters to the North before meeting his father in a street. How far away did the son meet his father from the starting point?

- A 140 meters
- B 260 meters
- C 100 meters
- D 80 meters

Answer: C

Explanation:

The following diagram shows his path:

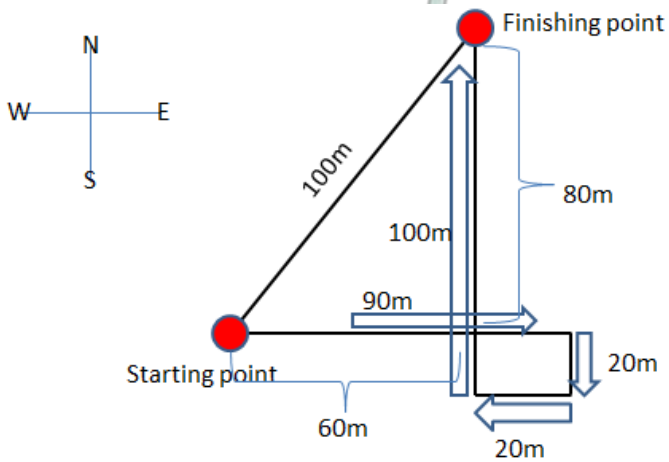

Using Pythagoras theorem, we can see that his actual displacement is 100m from the starting point to the finishing point.

Take 3 Free CAT Mocks (With Solutions)

54. Fill in the missing number in the series:

7, 13, 21, ____, 43, 57

- A 35
- B 30
- C 31
- D 34

Answer: C

Explanation:

The difference between consecutive terms is in A.P.

$$13 - 7 = 6$$

$$21 - 13 = 8$$

$$31 - 21 = 10$$

$$43 - 31 = 12$$

$$57 - 43 = 14$$

∴ 31 is the answer.

55. There are a 100 students in a graduating class. Of these, 80 students have passed (let us call this Set A), 20 have failed (let us call this Set B). 90 students from this class got a job (let us call this Set C). Given this information, which of the following statements is TRUE?

- A Set C intersects Set A but not Set B
- B Set B is a subset of Set C
- C Set A is a subset of Set C
- D Set C is a subset of the Union of Set A and Set B

Answer: D

Explanation:

A student can either fail or pass but both of them can get a job.

So there will be some students who passed and got a job and some who failed and got a job.

The venn diagram is shown below:

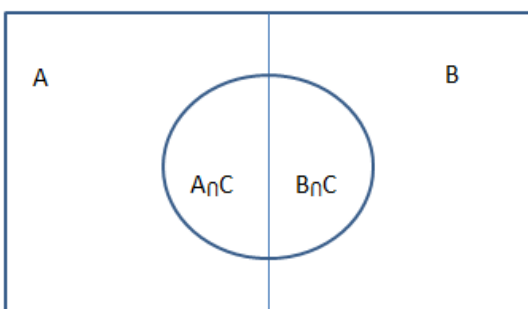

We get option D as answer.

56. If all angles in a triangle are equal, which of the following statements is true?

- A All sides are equal
- B Opposite sides are equal
- C Adjacent sides are equal
- D No side is equal to another

Answer: A

Explanation:

If all angles in a triangle are equal then all sides of the triangle will be equal.

XAT Free Mock Test

57. If the ratio of the number of men to the number of women on a committee of 30 is 7:8, how many members are women?

- A 7
- B 8
- C 16
- D 14

Answer: C

Explanation:

Let the number of men and women be $7x$ and $8x$. In total, there are 30 members in the committee.

So, $7x + 8x = 30$

$\Rightarrow x=2$

No. of women are $8 \times 2 = 16$

58. Find the missing set of letters in the following series

BAD , DAB , CAE , EAC , _____

A DAE

B DAC

C CAD

D DAF

Answer: D

Explanation:

In the series, the even terms are the reflection of their corresponding previous odd term.

Considering the 1st and 3rd letters of the odd terms, we can see there's an increment of 1 letter. So, after B comes C and then D will come after C and so on.

The middle term is always A.

So the 5th term will be DAF.

59. If all apples are red, and some apples are juicy, which of the following statements is true?

i) All apples are juicy.

ii) Some juicy apples are red.

iii) Some red apples are juicy.

A First statement

B Second and Third Statement

C Third Statement

D None of the above

Answer: B

Explanation:

From the statement given in the question, we can understand that all apples are red and among those, some are juicy.

The following Venn diagram can be drawn.

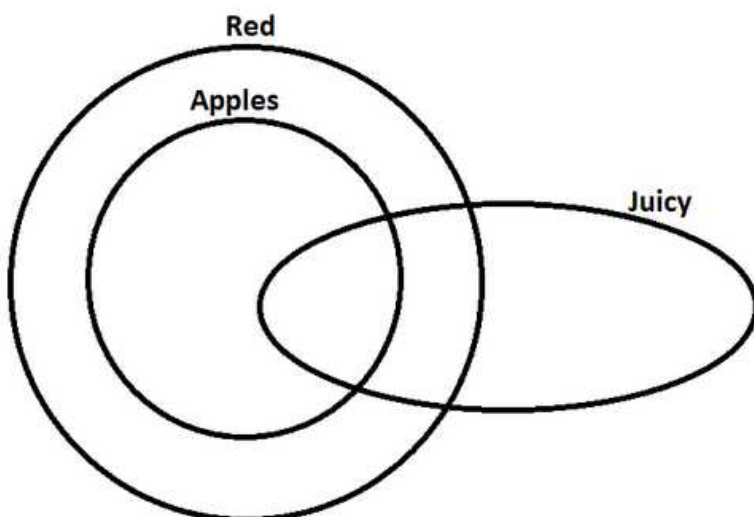

From the above diagram, we can surely infer that Some juicy apples are red and Some red apples are juicy.

Thus, B is correct.

Download IIFT Previous Papers PDF

60. Father's age and daughter's age add upto 55. Daughter's age is reverse of her father's and difference in their ages is more than 10. How old is the daughter?

- A 21
- B 14
- C 23
- D 32

Answer: B

Explanation:

Let the father's age be $10x+y$ and the daughter's age be $10y+x$

Difference between their ages is more than 10 years. So the eqn is:

$$(10x+y)-(10y+x)>10$$

$$\Rightarrow 9(x-y)>10$$

$$\Rightarrow (x-y)>1.11 \dots(1)$$

Also sum of their ages is 55.

$$(10x+y)+(10y+x)=55$$

$$\Rightarrow 11(x+y)=55$$

$$\Rightarrow x+y = 5 \dots(2)$$

Solving (1) and (2) together, we get $x=4$ and $y=1$

So, daughter's age is 14.

61. The canteen sells 4 types of chocolates - A,B,C,D. A costs Rs.10, B costs Rs.5, C costs Rs.8 and D costs Rs.11. I have Rs.100 with me to spend. If I buy, 4 chocolates of type D and 5 chocolates of type C, then how many chocolates of type A and B can I buy so that I use the maximum of the Rs.100 that I have.

- A 3 of Type B and 1 of Type A
- B 2 of Type B and 1 of Type A
- C 1 of Type B and 1 of Type A
- D None of the above

Answer: C

Explanation:

4 chocolates of type D cost Rs. 44 and 5 chocolates of type C cost Rs.40. So, Rs.84 is spent already. Now Rs.16 is left and cost per Chocolate of type A and B are multiples of 5. So to maximise the expenditure, 3 of type B and 0 of type A or 1 of type B and 1 of type A can be bought.

62. If the sequence 2, 4, 2, 4, 2, 4, ... continues as shown, then the sum of the first 19 terms is ____?

- A 62
- B 56

C 54

D 60

Answer: B

Explanation:

We can see 2 is in the odd places and 4 in the even places.

In the 1st 18 terms, there are 9 4's and 2's which sum up to 54 and the 19th term being 2 is added to get sum of 1st 19 terms as 56.

CAT Previous Papers PDF

63. What percentage of 1425 is 68.40?

A 4.30%

B 4.60%

C 4.80%

D 4.50%

Answer: C

Explanation:

let x% of 1425 be 68.40.

So, $(x/100) \times 1425 = 68.40$

$\Rightarrow x = 6840/1425$

$\Rightarrow x = 4.8\%$

64. If Number A is $(0.99)^2 \times (0.99)^3$ and Number B is $(0.99)^6$, then which number is bigger?

A Number A

B Number B

C Both numbers are equal

D Cannot be determined

Answer: A

Explanation:

When a number less than 1 but greater than zero is multiplied by itself, the product is less than the original number. Like $0.9 \times 0.9 = 0.81 < 0.9$

So, $(0.99^5) > (0.99^6)$

65. The following two figures show the contribution of the agricultural, industrial and services sectors to the economies of India and China respectively in the time period between 1940 and 2015. Based on the data represented in these figures, which of the following statements is TRUE:

- 1) India and China have both experienced similar economic trends in the past 75 years
- 2) The Chinese economy is dominated by industry whereas the Indian economy is dominated by the services sector
- 3) The Chinese economy is stronger than the Indian economy

India

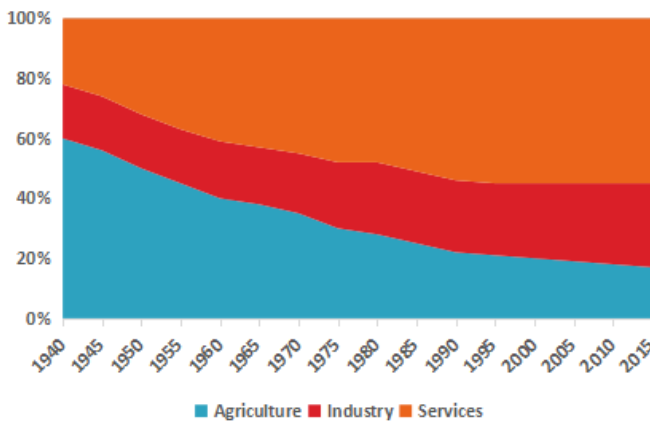

China

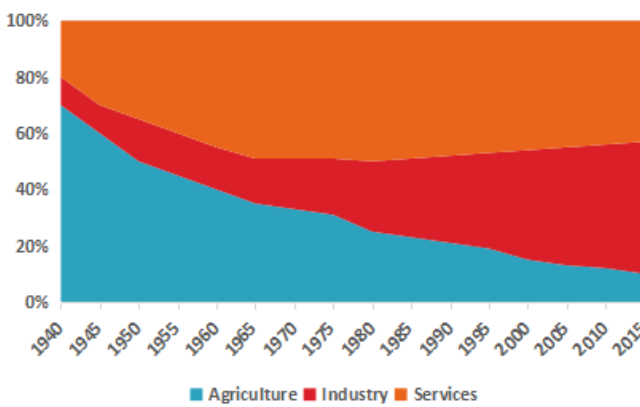

- A The first two statements are true and the third statement cannot be assessed based on the graph
- B The first statement is true and the other two cannot be assessed based on the graph
- C None of the statements can be assessed based on the graph
- D All of the statements are true

Answer: B

Explanation:

From the graph, we can see that the Indian and China economies have both experienced similar trends so statement one is true while the other two statements cannot be concluded from the graph so only first statement is true.

XAT Previous Papers PDF

66. If two numbers are in a ratio of 7:9 and their sum is 112, then which is the larger number?

- A 49
- B 72
- C 56

D 63

Answer: D

Explanation:

Let the 2 nos. be $7x$ and $9x$. As their sum is 112,

we can write $7x + 9x = 112$

$\Rightarrow x = 7$

So the larger number is $9 \times 7 = 63$

Instructions [67 - 68]

Comprehension:

The given line graph shows the percentage of the number of candidates who qualified in an examination out of the total number of candidates who appeared for the examination over a period of seven years from 1994 to 2000. Answer the following two questions based on the graph

Percentage

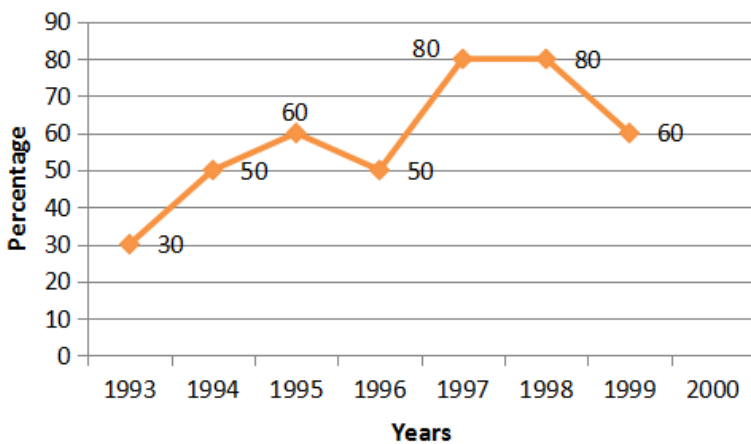

67. The percentage of candidates who qualified in the examination increased between 1994 and 1997 as well as between 1995 and 2000. Of these two time periods, in which time period was the percentage increase in the qualification of candidates the maximum?

- A 1995 to 2000
- B The two time periods cannot be compared
- C Increase was the same in both time periods
- D 1994 to 1997

Answer: D

Explanation:

From the graph, we can see clearly that the increase in the period from 1994-1997 is greater than the increase in the period in 1995-2000.

68. If the number of candidates that qualified in 1998 was 21200, what was the number of candidates that appeared in 1998?

- A 28500
- B 25000
- C 26500
- D 32000

Answer: C

Explanation:

Let x be the number of candidates who appeared for the exam.

From the graph, we can infer that in 1998, 80% of the students passed the exam, which is given to be 21200.

$$\text{So, } 80\% \text{ of } x = 21200$$

$$\Rightarrow \frac{80}{100} \times x = 21200$$

$$\Rightarrow \frac{4}{5} \times x = 21200$$

$$\Rightarrow x = \frac{5}{4} \times 21200$$

$\therefore x = 26500$, Option C

Top-500 Free CAT Questions (With Solutions)

Instructions [69 - 70]

Comprehension:

The following bar chart shows the education level of men in Village X. Please answer the following two questions based on the bar chart.

Male Literacy in Village X

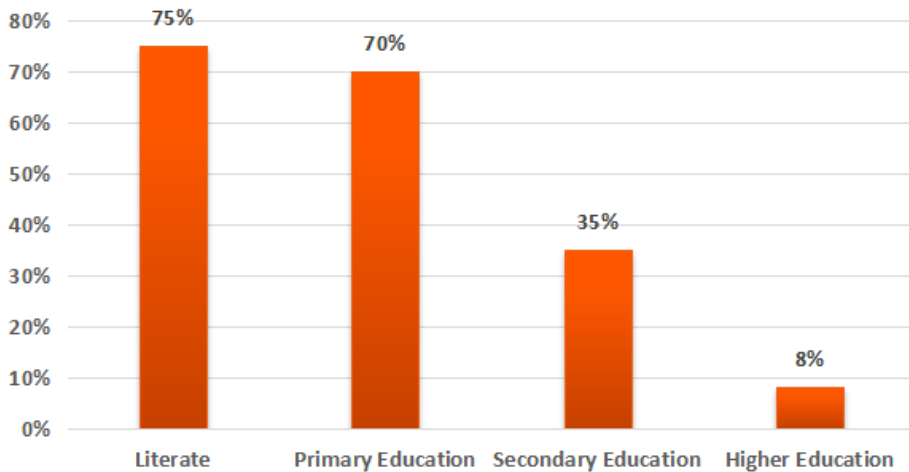

69. If the number of literate men is 1200, what is the number of men who have attained secondary level education?

- A 560
- B 288
- C 392
- D 420

Answer: A

Explanation:

Let the total number of men be x .

Given, the total percentage of literate people = 75%, which is given to be 1200.

$$\text{So, } 75\% \times x = 1200$$

$$\Rightarrow \frac{75}{100} \times x = 1200$$

$$\Rightarrow \frac{3}{4} \times x = 1200$$

$$\Rightarrow x = 1200 \times \frac{4}{3}$$

$\therefore x = 1600$.

It is given that 35% of the men have attained secondary level education.

So, 35% of 1600 = $\frac{35}{100} \times 1600 = 560$ is our answer.

70. If the population ratio (i.e. the proportion of men and women) in Village X is 10:8, and female literacy is 60%, estimate the number of literate women in Village X

- A 960
- B 576
- C 768
- D 720

Answer: C

Explanation:

Let the total number of men be x.

Given, the total percentage of literate people = 75%, which is given to be 1200.

$$\text{So, } 75\% \times x = 1200$$

$$\Rightarrow \frac{75}{100} \times x = 1200$$

$$\Rightarrow \frac{3}{4} \times x = 1200$$

$$\Rightarrow x = 1200 \times \frac{4}{3}$$

$\therefore x = 1600$.

Since men:women ratio is 10:8, i.e. for every 10 men, there are 8 women.

So, for 1600 men, number of women will be $\frac{8}{10} \times 1600 = 1280$.

Women literacy is given to be 60%.

So, number of literate women = $\frac{60}{100} \times 1280 = 768$ - Option C.

Take a XAT Free Mock Test

English Proficiency

71. Complete the sentence with the correct option.

The teacher added the stipulation that all projects had to be _____; no student could carry out research on an area that had already been explored by someone else.

- A original
- B constructive
- C extensive
- D convincing

Answer: A

Explanation:

According to the given context, no student should carry out research on an area that had already been covered by someone else. Therefore, it should be something new and original. Among the given options, 'original' is the most appropriate word.

Answer is option A.

Take a CMAT free mock test

72. "Had you been at the disaster site, you would have understood the magnitude of the destruction."
Of the given options, which one does NOT mean 'magnitude' as used in the above sentence?

- A enormity
- B scale
- C significance
- D quantum

Answer: C

Explanation:

In the given context, magnitude indicates the measure of the destruction. Among the given options, enormity, scale, and quantum infer a similar meaning. Therefore, the answer is option C.

73. Which option does NOT mean 'handed' in the sentence 'She handed the documents to the revenue officer'?

- A delivered
- B gave
- C handled
- D passed

Answer: C

Explanation:

In the given context, handed indicates the passing the documents or giving the documents. Among the given options, delivered, gave, and passed infer a similar meaning. Therefore, the answer is option C.

74. Choose the option that would make the sentence grammatically most correct.
The group of nurses are complaining about the lack of safety precautions in the hospital.

- A No change. The sentence is correct as is.
- B is complaining
- C were complained
- D did complaining

Answer: B

Explanation:

'The group of nurses' is a single entity.

Correct sentence: The group of nurses is complaining about the lack of safety precautions in the hospital.

Answer is option B.

Take a free SNAP mock test

75. Read the given statement and answer the question that follows:

Whenever I eat an icecream, I get a cold.

Which of the following statements is/are definitely true:

- I. If I never eat an icecream, I will never get a cold.
- II. Eating an icecream is one of the reasons for me to get a cold.
- III. If I have a cold, I must have eaten an icecream.

- A II only
- B I, II and III
- C Both I and III
- D III only

Answer: A

Explanation:

Statement I and III is not definitely true because there may be other reasons for cold.

Statement II is definitely true because it is mentioned that eating an icecream is one of the reasons for me to get a cold.

Answer is option A.

76. Complete the sentence with the correct option.

We were so delayed that the football match ___ by the time we ___.

- A already finished, arrived
- B had already finished, arrive
- C already finish, arrived
- D had already finished, arrived

Answer: D

Explanation:

Options B and C are incorrect, as the given statement is in past tense. As the statement is in past perfect form, option D is correct.

Answer is option D.

77. Choose the option that would make the sentence grammatically most correct.

Who's life is it anyway?

- A No change. The sentence is correct as is.
- B Whose life is it anyway?
- C Who life is it anyway?
- D Whose's life is it anyway?

Answer: B

Explanation:

The correct word to use instead of 'who's' is whose.

Correct sentence: Whose life is it anyway?

Answer is option B.

Take a NMAT free mock test

78. Complete the sentence with the correct option.

My wife and ___ will attend the function.

- A me
- B him

C myself

D I

Answer: D

Explanation:

In the given context, it cannot option B. Among the remaining options, 'I' is correct usage.

Correct sentence is 'My wife and I will attend the function.'

Answer is option D.

79. **Choose the option that would make the sentence grammatically most correct.**
The house as well as the garden were to be treated for a termite infestation.

A No change, the sentence is correct as is.

B The house as well as the garden is to be treated for a termite infestation.

C The house as well as the garden are going to be treated for a termite infestation.

D The house as well as the garden need to be treated for a termite infestation.

Answer: B

Explanation:

When "as well as" is used to talk about two subjects, the auxiliary verb used is for a singular entity only.

Hence, among the options, B is the answer.

80. **Complete the sentence with the correct option**

Nearly _____ by disease and the destruction of their habitat, Koalas are now found only in isolated parts of eucalyptus forests.

A damaged

B destroyed

C decimated

D dispersed

Answer: C

Explanation:

'decimated' is used when addressing a disease.

Answer is option C.

[Download IIFT Previous papers PDF](#)

81. **Which of the following is the closest in meaning to the word 'retribution'?**

A return

B reinstatement

C reiteration

D revenge

Answer: D

Explanation:

retribution - act of taking revenge

Answer is option D.

82. Identify the error in the sentence, if any:

Modern cinematography/(1) techniques are far superior to/(2) that employed in the past./(3) No Error/(4)

- A Modern cinematography
- B are far superior to
- C that employed in the past.
- D No Error.

Answer: C

Explanation:

Techniques are in plural form and the pronoun for it must be plural. Therefore, 'those' is used instead of 'that' in the given sentence.

Correct sentence: Modern cinematography techniques are far superior to those employed in the past.

Answer is option C.

83. Identify the error in the sentence, if any:

He wondered whether he could make it/(1) through the storm as there was no safe haven in sight/(2) and it was pouring cats and dogs, with the roads full with gushing water./(3) Error./(4)

- A he could make it
- B no safe haven in sight
- C full with gushing water
- D No Error.

Answer: C

Explanation:

There is an error in option C, and the error is use of preposition. In the given context, 'of' should be used instead of 'with'.

Correct sentence: He wondered whether he could make it through the storm as there was no safe haven in sight and it was pouring cats and dogs, with the roads full of gushing water.

Answer is option C.

XAT Previous Papers

84. Complete the sentence with the correct option.

It's a wonder that ----- still such a popular band even after twenty years of being on the music charts!

- A they're
- B their's
- C there
- D their

Answer: A

Explanation:

The sentence talks about some band. Thus, the correct word that will fill the blank is "they're".

"There" is used to show some place, whereas "their" and "their's" are possessive pronouns. Thus, these are not suitable for the sentence.

Hence, the answer is option A.

85. Complete the sentence with the correct option.

None of the students prepared for the examination. As far as answering the examination paper was concerned, they were all _____.

- A making their mark
- B sailing in the same boat
- C scoring a sitter
- D barking up the wrong tree

Answer: B

Explanation:

sailing in the same boat is an idiom used when a person is in same unpleasant situation as other people. This idiom is appropriate in the given context.

Answer is option B.

86. Complete the sentence with the correct option.

The itinerary set by their travel agent included so many stops in a _____ amount of time that they received only the most _____ impressions of the places they visited.

- A sufficient ... cursory
- B generousabiding
- C brief....fleeting
- D limited ... lasting

Answer: C

Explanation:

The language of the sentence suggests that the people had very less time and thus were not able to get any lasting impressions of the places they visited.

Thus, among the options, "brief" and "fleeting" are the most appropriate choices for the blanks.

Hence, the answer is option C.

CMAT Free Solved Previous Papers.

87. Identify the error in the sentence, if any:

In this way, nuclear fission/(1) or the splitting of the atoms/(2) have been achieved./(3) No Error./(4)

- A In this way nuclear fission
- B or the splitting of the atoms
- C have been achieved.
- D No Error.

Answer: C

Explanation:

Since nuclear fission is being talked about singularly, the sentence should have been, "In this way, nuclear fission or the splitting of the atoms has been achieved."

Hence, the answer is option C.

88. Complete the sentence with the correct option.

Ms. Kapoor recommended perseverance and _____ in dealing with the activists rather than the uncompromising approach the government had adopted.

- A patience
- B persistence
- C joviality
- D acrimony

Answer: A

Explanation:

The word appearing in the blank must be complementary to the word "perseverance".

Option B cannot be the answer since it is similar in meaning to "perseverance"

Option C is rejected because the sentence structure requires a word more serious in nature.

Option D is rejected because it is negative in tone and thus, does not suit the sentence.

Hence, the answer is option A as "perseverance and patience" are complementary to each other and support the sentence.

89. Complete the sentence with the correct option:

The land reforms were diluted, if not sabotaged, in _____ with politicians and highly placed legal officials.

- A collusion
- B agreement
- C pandemonium
- D cooperation

Answer: A

Explanation:

The sentence talks about "dilution" and "sabotage" in the land reforms, which indicates a negative tone.

Thus, among the options, "collusion" is the most suitable word for the answer.

Hence, the answer is option A.

MAT Free Solved Previous Papers

90. Identify the error in the sentence, if any:

Neither the Bank manager nor the other/(1) staff members was able/(2) to calm the distressed client./(3) No Error/(4)

- A nor the other
- B was able
- C the distressed client
- D No Error.

Answer: B

Explanation:

'was able' is incorrect form in this context.

Correct sentence: Neither the Bank manager nor the other staff members **were able** to calm the distressed client.

Answer is option B.

Instructions [91 - 95]

Read the following passage and answer the FIVE questions that follow.

Comprehension:

To those who do listen, the desert speaks of things with an emphasis quite different from that of the shore, the mountain, the valley or the plains. Whereas these invite action and suggest limitless opportunity and exhaust less resources, the implications and the mood of the desert are something different. For one thing, the desert is conservative and not radical. It is more likely to provide awe than to invite conquest. The heroism which it encourages is the heroism of endurance, not that of conquest. It brings man up against this limitation, turns him upon himself and suggests values which more indulgent regions suppress. Sometimes it includes contemplation in men who have never contemplated before. And of all the answers to the question- what is a desert good for - 'contemplation' is perhaps the best.

91. In order to receive the desert's message, the beholder needs to be

- A a good listener
- B courageous in his reaction
- C reflective by nature
- D conservative in his responses

Answer: C

Explanation:

The author says, "It brings man up against this limitation, turns him upon himself and suggests values which more indulgent regions suppress. Sometimes it includes contemplation in men who have never contemplated before."

Thus, the desert needs the beholder to be reflective in order to receive its message.

Hence, the answer is option C.

92. The phrase "it brings man up against his limitations" indicates that _____

- A man feels hopeless about his limitations
- B man is made aware of his limitations.
- C man is persuaded to overcome his limitations.
- D man is compelled to fight against his limitations

Answer: B

Explanation:

The author says that the desert brings man against his limitations and makes him contemplate. Thus, in the context of the passage, option B is the correct answer to this question.

Take 3 Free CAT Mocks (With Solutions)

93. The desert is unique among landscapes in that it is relatively_____.

- A constant
- B judgemental
- C adventurous
- D conventional

Answer: A

Explanation:

The author says, "For one thing, the desert is conservative and not radical."

Thus, among the options, option A is the most suitable choice.

94. The writer calls the desert "conservative rather than radical" because it provides an environment that _____.

- A inspires one to test one's endurance
- B makes one gloomy
- C inspires man to explore it
- D offers unlimited opportunity to conquer it

Answer: A

Explanation:

The author says, "The heroism which it encourages is the heroism of endurance, not that of conquest."

Thus, the answer is option A.

95. If one responds with insight to the mood of the desert, it evokes

- A intense conflict
- B deep thoughtfulness
- C heroic conquest
- D resourcefulness

Answer: B

Explanation:

The author says, "It brings man up against this limitation, turns him upon himself and suggests values which more indulgent regions suppress."

Thus, the desert makes a man contemplative/reflective.

Hence, the answer is option B.

XAT Free Mock Test

Instructions [96 - 100]

Read the following passage and answer the FIVE questions that follow.

Comprehension:

Before the grass has thickened on the roadside verges and leaves have started growing on the trees is a perfect time to look around and see just how dirty Britain has become. The pavements are stained with chewing gum that has been spat out and the gutters are full of discarded fast food cartons. Years ago I remember travelling abroad and being saddened by the plastic bags, discarded bottles and soiled nappies at the edge of every road. Nowadays, Britain seems to look at least as bad. What has gone wrong?

The problem is that the rubbish created by our increasingly mobile lives lasts a lot longer than before. If it is not cleared up and properly thrown away, it stays in the undergrowth for years; a semi-permanent reminder of what a tatty little country we have now.

Firstly, it is estimated that 10 billion plastic bags have been given to shoppers. These will take anything from 100 to 1,000 years to rot. However, it is not as if there is no solution to this. A few years ago, the Irish government introduced a tax on non-recyclable carrier bags and in three months reduced their use by 90%. When he was a minister, Michael Meacher attempted to introduce a similar arrangement in Britain. The plastics industry protested, of course. However, they need not have bothered; the idea was killed before it could draw breath, leaving supermarkets free to give away plastic bags.

What is clearly necessary right now is some sort of combined initiative, both individual and collective, before it is too late. The alternative is

to continue sliding downhill until we have a country that looks like a vast municipal rubbish tip. We may well be at the tipping point. Yet we know that people respond to their environment. If things around them are clean and tidy, people behave cleanly and tidily. If they are surrounded by squalor, they behave squalidly. Now, much of Britain looks pretty squalid. What will it look like in five years?

96. It is general knowledge that

- A people behave according to what they see around them.
- B people are like a vast municipal rubbish tip.
- C people are clean and tidy.
- D people are squalid.

Answer: A

Explanation:

In the last paragraph, the author states, "we know that people respond to their environment. If things around them are clean and tidy, people behave cleanly and tidily. If they are surrounded by squalor, they behave squalidly."

Hence, the answer is option A.

97. **Michael Meacher**

- A issued orders to follow the Irish example with a tax on plastic bags.
- B tried to follow the Irish example with a tax on plastic bags.
- C followed the Irish example with a tax on plastic bags.
- D questioned the plastics industry who weren't bothered about the tax

Answer: B

Explanation:

"Michael Meacher attempted to introduce a similar arrangement in Britain. The plastics industry protested, of course. However, they need not have bothered; the idea was killed before it could draw breath,"

Hence, the answer is option B.

98. **According to the writer, years ago, things used to be**

- A the same abroad as compared to Britain
- B better abroad as compared to Britain
- C worse abroad as compared to Britain
- D worse, but now things are better abroad

Answer: C

Explanation:

"Years ago I remember travelling abroad and being saddened by the plastic bags, discarded bottles and soiled nappies at the edge of every road. Nowadays, Britain seems to look at least as bad."

Hence, the answer is option C.

Download IIFT Previous Papers PDF

99. **For the writer, the problem is that**

- A rubbish lasts longer than it used to.
- B Britain is a tatty country.
- C rubbish is not cleared up.

D our society is increasingly mobile.

Answer: A

Explanation:

The author talks about plastics nowadays lasting longer than before. They also talk about methods used by some countries to reduce single-use plastic.

He also mentions this by saying, *"The problem is that the rubbish created by our increasingly mobile lives lasts a lot longer than before."*

Hence, the answer is option A.

100. **The writer thinks**

A we need to work together to solve the problem.

B we are at the tipping point.

C it is too late to do anything.

D there is no alternative.

Answer: A

Explanation:

The author says, *"What is clearly necessary right now is some sort of combined initiative, both individual and collective, before it is too late."*

Hence, the answer is option A.

[CAT Previous Papers PDF](#)

[Download IIFT Previous papers PDF](#)

[XAT Previous Papers](#)

[CMAT Free Solved Previous Papers.](#)

[MAT Free Solved Previous Papers](#)

[Take 3 Free CAT Mocks \(With Solutions\)](#)

[XAT Free Mock Test](#)

[Download IIFT Previous Papers PDF](#)

[CAT Previous Papers PDF](#)

[XAT Previous Papers PDF](#)

[Top-500 Free CAT Questions \(With Solutions\)](#)

[Take a XAT Free Mock Test](#)

[Take a CMAT free mock test](#)

[Take a free SNAP mock test](#)

[Take a NMAT free mock test](#)