

National Testing Agency

Question Paper Name:	BTECH 8th Jan 2020 Shift 2
Subject Name:	BTECH
Creation Date:	2020-01-08 18:54:28
Duration:	180
Total Marks:	300
Display Marks:	Yes

BTECH

Group Number :	1
Group Id :	40503621
Group Maximum Duration :	0
Group Minimum Duration :	180
Show Attended Group? :	No
Edit Attended Group? :	No
Break time:	0
Group Marks:	300
Is this Group for Examiner?:	No

Physics

Section Id :	40503666
Section Number :	1
Section type :	Online
Mandatory or Optional:	Mandatory
Number of Questions:	25
Number of Questions to be attempted:	25
Section Marks:	100

Sub-Section Number:	1
Sub-Section Id:	405036104
Question Shuffling Allowed :	Yes

**Question Number : 1 Question Type : MCQ Option Shuffling : Yes
Correct Marks : 4 Wrong Marks : 1**

A simple pendulum is being used to determine the value of gravitational acceleration g at a certain place. The length of the pendulum is 25.0 cm and a stop watch with 1 s resolution measures the time taken for 40 oscillations to be 50 s. The accuracy in g is :

Options :

1. 3.40%

2. 2.40%

3. 4.40%

4. 5.40%

Question Number : 1 Question Type : MCQ Option Shuffling : Yes

Correct Marks : 4 Wrong Marks : 1

एक साधारण लोलक का प्रयोग किसी स्थान पर गुरुत्वाकर्षण के कारण त्वरण g का मान ज्ञात करने के लिये किया जाता है। यदि लोलक की लम्बाई 25.0 cm हो और इसके 40 दोलनों के लिये एक 1 s वियोजन (resolution) वाली स्टॉपवाच से नापा गया समय 50 s हो तो g के मान की परिशुद्धता (accuracy) होगी :

Options :

1. 3.40%

2. 2.40%

3. 4.40%

4. 5.40%

Question Number : 1 Question Type : MCQ Option Shuffling : Yes

Correct Marks : 4 Wrong Marks : 1

ચોક્કસ જગ્યાએ ગુરુત્વય પ્રવેગનું મૂલ્ય નક્કી કરવામાટે એક સાદા લોલકનો ઉપયોગ કરવામાં આવે છે. આ લોલકની લંબાઈ 25.0 cm છે અને 1s વિભેદન ધરાવતી સ્ટોપ વોચ 40 દોલનો માટે 50 s જેટલો સમય નોંધે છે. g ના માપનમાં ચોક્કસાઈ _____ છે.

Options :

1. 3.40%

2. 2.40%

3. 4.40%

4. 5.40%

Question Number : 2 Question Type : MCQ Option Shuffling : Yes
Correct Marks : 4 Wrong Marks : 1

A particle moves such that its position

vector $\vec{r}(t) = \cos\omega t \hat{i} + \sin\omega t \hat{j}$ where ω is a constant and t is time. Then which of the following statements is true for the velocity

$\vec{v}(t)$ and acceleration $\vec{a}(t)$ of the particle :

Options :

1. \vec{v} and \vec{a} both are parallel to \vec{r}

\vec{v} and \vec{a} both are perpendicular to

2. \vec{r}

3. \vec{v} is perpendicular to \vec{r} and \vec{a} is directed towards the origin

4. \vec{v} is perpendicular to \vec{r} and \vec{a} is directed away from the origin

Question Number : 2 Question Type : MCQ Option Shuffling : Yes
Correct Marks : 4 Wrong Marks : 1

एक चलायमान कण की समय t पर स्थिति

$\vec{r}(t) = \cos\omega t \hat{i} + \sin\omega t \hat{j}$ वेक्टर द्वारा दी जाती है। यहाँ पर ω एक स्थिरांक है। ऐसे में कण के वेग

$\vec{v}(t)$ तथा इसके त्वरण $\vec{a}(t)$ के लिये निम्न में से कौन सा कथन सत्य है?

Options :

1. \vec{v} और \vec{a} दोनों ही \vec{r} के समानान्तर हैं।
2. \vec{v} और \vec{a} दोनों ही \vec{r} के लम्बवत् हैं।
3. \vec{v} लम्बवत् है \vec{r} के तथा \vec{a} की दिशा मूल बिन्दु की ओर है।
4. \vec{v} लम्बवत् है \vec{r} के तथा \vec{a} की दिशा मूल बिन्दु से दूर जाती हुई है।

Question Number : 2 Question Type : MCQ Option Shuffling : Yes
Correct Marks : 4 Wrong Marks : 1

એક કણ એવી રીતે ગતિ કરે છે કે તેના સ્થાન સદિશ

$$\vec{r}(t) = \cos\omega t \hat{i} + \sin\omega t \hat{j} \text{ છે. જ્યાં } \omega \text{ એ}$$

અચળાંક અને t એ સમય છે. તો કણના વેગ $\vec{v}(t)$

અને પ્રવેગ $\vec{a}(t)$ માટે નીચેનામાંથી કયું વિધાન સાચું છે?

Options :

1. \vec{v} અને \vec{a} બંને \vec{r} ને સમાંતર છે.

2. \vec{v} અને \vec{a} બંને \vec{r} ને લંબ છે.

3. \vec{v} એ \vec{r} ને લંબ છે અને \vec{a} ની દિશા ઉગમ બિન્દુ તરફ છે.

4. \vec{v} એ \vec{r} ને લંબ છે અને \vec{a} ની દિશા ઉગમ બિન્દુ થી દૂર તરફ છે.

Question Number : 3 Question Type : MCQ Option Shuffling : Yes

Correct Marks : 4 Wrong Marks : 1

A particle of mass m is dropped from a height h above the ground. At the same time another particle of the same mass is thrown vertically upwards from the ground with a speed of $\sqrt{2gh}$. If they collide head-on completely inelastically, the time taken for the combined mass to

reach the ground, in units of $\sqrt{\frac{h}{g}}$ is :

Options :

1. $\frac{1}{2}$

2. $\sqrt{\frac{3}{2}}$

3. $\sqrt{\frac{3}{4}}$

4. $\sqrt{\frac{1}{2}}$

Question Number : 3 Question Type : MCQ Option Shuffling : Yes

Correct Marks : 4 Wrong Marks : 1

m द्रव्यमान के एक कण को धरातल से h ऊँचाई से छोड़ा जाता है। उसी समय पर समान द्रव्यमान के एक कण को धरातल से ऊर्ध्वाधर दिशा में ऊपर की ओर $\sqrt{2gh}$ गति से प्रक्षेपित करा जाता है। यदि ये दो कण आमने-सामने (head-on) पूर्णतः अप्रत्यास्थ रूप से टकराते हैं तो जुड़े हुए कणों को $\sqrt{\frac{h}{g}}$ की इकाई मानते हुए धरातल तक पहुँचने में लगने वाला समय होगा :

Options :

1. $\frac{1}{2}$

2. $\sqrt{\frac{3}{2}}$

3. $\sqrt{\frac{3}{4}}$

4. $\sqrt{\frac{1}{2}}$

Question Number : 3 Question Type : MCQ Option Shuffling : Yes

Correct Marks : 4 Wrong Marks : 1

જમીન થી h જેટલી ઉંચાઈ પર થી m દળ ધરાવતા એક કણને છોડવામાં આવે છે. આટલા જ દળના બીજા કણને આ જ સમયે જમીન પરથી $\sqrt{2gh}$ જેટલી ઝડપથી ઉર્ધ્વદિશામાં ઉપરની તરફ ફેંકવામાં આવે છે. જો તેઓ ની સીધી અથડામણ સંપૂર્ણ અસ્થિતિસ્થાપક હોય તો સંયુક્ત દળ ને જમીન સુધી પહોંચતા લાગતો સમય,

$\sqrt{\frac{h}{g}}$ ના એકમમાં, _____ છે.

Options :

1. $\frac{1}{2}$

2. $\sqrt{\frac{3}{2}}$

3. $\sqrt{\frac{3}{4}}$

4. $\sqrt{\frac{1}{2}}$

Question Number : 4 Question Type : MCQ Option Shuffling : Yes

Correct Marks : 4 Wrong Marks : 1

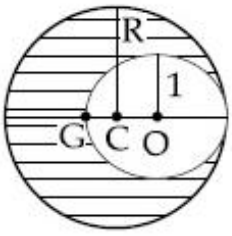

As shown in fig. when a spherical cavity (centred at O) of radius 1 is cut out of a uniform sphere of radius R (centred at C), the centre of mass of remaining (shaded) part of sphere is at G, i.e on the surface of the cavity. R can be determined by the equation :

Options :

1. $(R^2 + R - 1)(2 - R) = 1$

2. $(R^2 - R + 1)(2 - R) = 1$

3. $(R^2 + R + 1)(2 - R) = 1$

4. $(R^2 - R - 1)(2 - R) = 1$

Question Number : 4 Question Type : MCQ Option Shuffling : Yes
Correct Marks : 4 Wrong Marks : 1

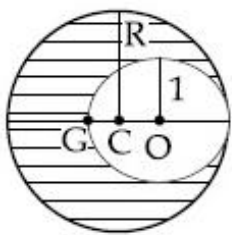

दिखाये गये चित्रानुसार जब R त्रिज्या के एक एकसमान गोले में (गोले का केन्द्र C पर है) 1 त्रिज्या की एक गुहिका (cavity) बनाई जाती है (गुहिका का केन्द्र O पर है) तो बचे हुए हिस्से (छायादित) का द्रव्यमान केन्द्र G बिन्दु (जो कि गुहिका की सतह पर है) है। ऐसे में R का मान निम्न में से कौन सी समीकरण द्वारा ज्ञात किया जा सकता है?

Options :

1. $(R^2 + R - 1)(2 - R) = 1$

2. $(R^2 - R + 1)(2 - R) = 1$

3. $(R^2 + R + 1)(2 - R) = 1$

4. $(R^2 - R - 1)(2 - R) = 1$

Question Number : 4 Question Type : MCQ Option Shuffling : Yes
Correct Marks : 4 Wrong Marks : 1

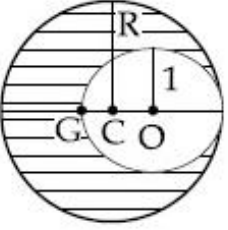

જ્યારે R ત્રિજ્યાવાળા એક નિયમિત ગોળા (જેનું કેન્દ્ર C આગળ છે) માંથી 1 ત્રિજ્યાવાળા એક ગોળાકાર બખોલ (કાણું) (જેનું કેન્દ્ર O આગળ છે) ને આકૃતિમાં બતાવ્યા પ્રમાણે કાપવામાં આવે છે ત્યારે ગોળાના બાકી રહેલા ભાગ (આચ્છાદીત કરેલ) નું દ્રવ્યમાન કેન્દ્ર G આગળ છે, એટલે કે, બખોલ (કાણું) ની સપાટી પર છે. R _____ સમીકરણની રીતે મળી શકે.

Options :

1. $(R^2 + R - 1)(2 - R) = 1$

2. $(R^2 - R + 1)(2 - R) = 1$

3. $(R^2 + R + 1)(2 - R) = 1$

4. $(R^2 - R - 1)(2 - R) = 1$

Question Number : 5 Question Type : MCQ Option Shuffling : Yes

Correct Marks : 4 Wrong Marks : 1

A uniform sphere of mass 500 g rolls without slipping on a plane horizontal surface with its centre moving at a speed of 5.00 cm/s. Its kinetic energy is :

Options :

1. 6.25×10^{-4} J

2. 1.13×10^{-3} J

3. 8.75×10^{-4} J

4. 8.75×10^{-3} J

Question Number : 5 Question Type : MCQ Option Shuffling : Yes

Correct Marks : 4 Wrong Marks : 1

500 g द्रव्यमान का एक एकसमान गोला बिना फिसले हुए एक क्षैतिज समतल सतह पर लुढ़कता हुआ चल रहा है (rolls without slipping) तथा इसके द्रव्यमान केन्द्र की गति 5.00 cms^{-1} है। गोले की गतिज ऊर्जा है :

Options :

1. 6.25×10^{-4} J

2. 1.13×10^{-3} J

3. 8.75×10^{-4} J

4. $8.75 \times 10^{-3} \text{ J}$

Question Number : 5 Question Type : MCQ Option Shuffling : Yes

Correct Marks : 4 Wrong Marks : 1

500 g દળવાળા એક નિયમિત ગોળાને તેનું કેન્દ્ર 5.00 cms^{-1} ઝડપથી ગતિ કરે એવી રીતે એક સમતલ સમક્ષિતિજ સપાટી પર સરકે નહી તે રીતે ગબડાવવામાં આવે છે. તેની ગતિઊર્જા _____ છે.

Options :

1. $6.25 \times 10^{-4} \text{ J}$

2. $1.13 \times 10^{-3} \text{ J}$

3. $8.75 \times 10^{-4} \text{ J}$

4. $8.75 \times 10^{-3} \text{ J}$

Question Number : 6 Question Type : MCQ Option Shuffling : Yes

Correct Marks : 4 Wrong Marks : 1

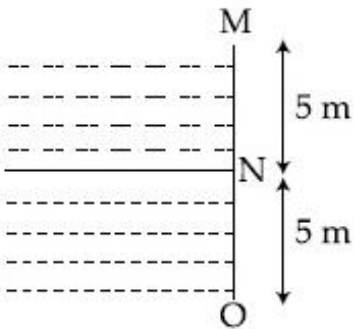

Two liquids of densities ρ_1 and ρ_2 ($\rho_2 = 2\rho_1$) are filled up behind a square wall of side 10 m as shown in figure. Each liquid has a height of 5 m. The ratio of the forces due to these liquids exerted on upper part MN to that at the lower part NO is (Assume that the liquids are not mixing) :

Options :

1. $2/3$

2. $1/2$

3. $1/3$

4. $1/4$

Question Number : 6 Question Type : MCQ Option Shuffling : Yes

Correct Marks : 4 Wrong Marks : 1

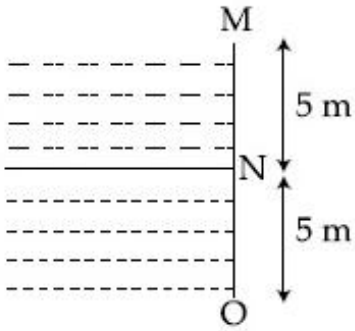

भिन्न घनत्वों ρ_1 तथा ρ_2 ($\rho_2 = 2\rho_1$) के दो द्रव 10 m लम्बाई की एक वर्गाकार दीवार के पीछे भरे हुए हैं (चित्र देखें)। प्रत्येक द्रव की ऊँचाई 5 m है। तब इन द्रवों द्वारा दीवार के ऊपरी भाग MN तथा निचले भाग NO पर लगने वाले बलों का अनुपात होगा (यह मानें कि ये द्रव मिश्रित नहीं होते हैं)

Options :

1. $2/3$

2. $1/2$

3. $1/3$

4. $1/4$

Question Number : 6 Question Type : MCQ Option Shuffling : Yes

Correct Marks : 4 Wrong Marks : 1

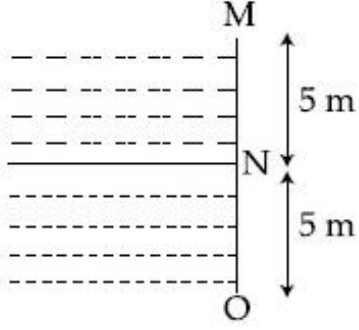

આકૃતિમાં બતાવ્યા પ્રમાણે 10 m બાજુવાળા ચોરસની પાછળના ભાગે ρ_1 અને ρ_2 ($\rho_2 = 2\rho_1$) ઘનતા ધરાવતા બે પ્રવાહીને ભરવામાં આપેલા છે. દરેક પ્રવાહીની ઉંચાઈ 5 m છે. પ્રવાહીને સીધે ઉપરના ભાગ MN અને નીચેના ભાગ NO પર લાગતા બળોનો ગુણોત્તર _____ છે. (એવું ધારોકે પ્રવાહીઓ એકબીજામાં ભળતા નહીં)

Options :

1. $2/3$

2. $1/2$

3. $1/3$

4. $1/4$

Question Number : 7 Question Type : MCQ Option Shuffling : Yes

Correct Marks : 4 Wrong Marks : 1

A Carnot engine having an efficiency of $\frac{1}{10}$ is being used as a refrigerator. If the work done on the refrigerator is 10 J, the amount of heat absorbed from the reservoir at lower temperature is :

Options :

1. 100 J
2. 99 J
3. 90 J
4. 1 J

Question Number : 7 Question Type : MCQ Option Shuffling : Yes

Correct Marks : 4 Wrong Marks : 1

एक कार्नो इंजन की दक्षता (efficiency) $\frac{1}{10}$ है और इसे एक रेफ्रिजरेटर के रूप में प्रयोग में लाया जा रहा है। यदि रेफ्रिजरेटर पर किया जाने वाला कार्य 10 J हो तो निम्नताप वाले तापकुण्ड से अवशोषित की जाने वाली ऊष्मा का मान है :

Options :

1. 100 J
2. 99 J
3. 90 J
4. 1 J

Question Number : 7 Question Type : MCQ Option Shuffling : Yes

Correct Marks : 4 Wrong Marks : 1

કાર્નો એન્જિનની કાર્યદક્ષતા $\frac{1}{10}$ માં ભાગની છે, જેનો ફીજ તરીકે ઉપયોગ થાય છે. જો ફીજ પર થતું કાર્ય 10 J હોય તો નીચા તાપમાને ઠારણ વ્યવસ્થામાંથી શોષાતી ઉષ્માની જથ્થો _____ છે.

Options :

1. 100 J

2. 99 J

3. 90 J

4. 1 J

Question Number : 8 Question Type : MCQ Option Shuffling : Yes

Correct Marks : 4 Wrong Marks : 1

Consider a mixture of n moles of helium gas and $2n$ moles of oxygen gas (molecules taken to be rigid) as an ideal gas. Its C_p/C_v value will be :

Options :

1. 67/45

2. 23/15

3. 19/13

4. 40/27

Question Number : 8 Question Type : MCQ Option Shuffling : Yes

Correct Marks : 4 Wrong Marks : 1

हीलियम गैस के n मोल्स और ऑक्सीजन गैस (इसके अणुओं को दृढ़ माने) के $2n$ मोल्स की मिश्रण को आदर्श गैस मानें तो इस मिश्रण के लिये C_p/C_v का मान होगा :

Options :

1. $67/45$

2. $23/15$

3. $19/13$

4. $40/27$

Question Number : 8 Question Type : MCQ Option Shuffling : Yes

Correct Marks : 4 Wrong Marks : 1

n मोल धरावता He वायु अने $2n$ मोल धरावता ऑक्सीजन वायु (आणुओने दृढ तरीके लो) ना मिश्रणने आदर्शवायु तरीके लो. तेना C_p/C_v नुं मूल्य _____ हसे.

Options :

1. $67/45$

2. $23/15$

3. $19/13$

Question Number : 9 Question Type : MCQ Option Shuffling : Yes

Correct Marks : 4 Wrong Marks : 1

A transverse wave travels on a taut steel wire with a velocity of v when tension in it is 2.06×10^4 N. When the tension is changed to T , the velocity changed to $v/2$.

The value of T is close to :

Options :

1. 2.50×10^4 N

2. 5.15×10^3 N

3. 30.5×10^4 N

4. 10.2×10^2 N

Question Number : 9 Question Type : MCQ Option Shuffling : Yes

Correct Marks : 4 Wrong Marks : 1

जब एक तने हुए स्टील के तार में तनाव 2.06×10^4 N हो तो इस पर चलने वाली एक अनुप्रस्थ तरंग की गति v है। यदि तनाव का मान बदलकर T कर दिया जाये तो तरंग की गति बदलकर $v/2$ हो जाती है। T का मान निम्न में से किसके निकटतम है?

Options :

1. 2.50×10^4 N

2. 5.15×10^3 N

3. $30.5 \times 10^4 \text{ N}$

4. $10.2 \times 10^2 \text{ N}$

Question Number : 9 Question Type : MCQ Option Shuffling : Yes
Correct Marks : 4 Wrong Marks : 1

જ્યારે ખેંચાયેલા સ્ટીલ તારનું તણાવ $2.06 \times 10^4 \text{ N}$ છે ત્યારે તેમાંથી પસાર થતા લંબગત તરંગનો વેગ v છે. જ્યારે તણાવ બદલીને T થાય છે ત્યારે તેનો વેગ બદલાયને $v/2$ થાય છે. T નું મૂલ્ય _____ ની નજીક છે.

Options :

1. $2.50 \times 10^4 \text{ N}$

2. $5.15 \times 10^3 \text{ N}$

3. $30.5 \times 10^4 \text{ N}$

4. $10.2 \times 10^2 \text{ N}$

Question Number : 10 Question Type : MCQ Option Shuffling : Yes
Correct Marks : 4 Wrong Marks : 1

Consider two charged metallic spheres S_1 and S_2 of radii R_1 and R_2 , respectively. The electric fields E_1 (on S_1) and E_2 (on S_2) on their surfaces are such that $E_1/E_2 = R_1/R_2$. Then the ratio $V_1(\text{on } S_1)/V_2(\text{on } S_2)$ of the electrostatic potentials on each sphere is :

Options :

1. R_1/R_2

2. $(R_1/R_2)^2$

3. $\left(\frac{R_1}{R_2}\right)^3$

4. (R_2/R_1)

Question Number : 10 Question Type : MCQ Option Shuffling : Yes
Correct Marks : 4 Wrong Marks : 1

धातुओं से बने हुए दो गोले S_1 और S_2 , जिनकी त्रिज्याएँ क्रमशः R_1 और R_2 है आवेशित है। यदि इनकी सतह पर विद्युत क्षेत्र E_1 (S_1 पर) तथा E_2 (S_2 पर) ऐसे हैं कि $E_1/E_2 = R_1/R_2$ तो इन पर स्थिर वैद्युत वोल्टता V_1 (S_1 पर) तथा V_2 (S_2 पर) का अनुपात V_1/V_2 होगा :

Options :

1. R_1/R_2

2. $(R_1/R_2)^2$

3. $\left(\frac{R_1}{R_2}\right)^3$

4. (R_2/R_1)

Question Number : 10 Question Type : MCQ Option Shuffling : Yes
Correct Marks : 4 Wrong Marks : 1

R_1 અને R_2 ત્રિજ્યા ધરાવતા બે વીજભારિત ધાતુના ગોળાઓ S_1 અને S_2 હો. તેમની સપાટીઓ S_1 પરનું વિદ્યુતક્ષેત્ર E_1 અને S_2 પરનું ક્ષેત્ર E_2 એવી રીતે છે કે જેવી $E_1/E_2 = R_1/R_2$ થાય. તો દરેક ગોળા પરનો સ્થિત વિદ્યુત સ્થિતિમાનનો ગુણોત્તર $V_1(S_1 \text{ પર}) / V_2(S_2 \text{ પર})$ _____ છે.

Options :

1. R_1/R_2

2. $(R_1/R_2)^2$

3. $\left(\frac{R_1}{R_2}\right)^3$

4. (R_2/R_1)

Question Number : 11 Question Type : MCQ Option Shuffling : Yes

Correct Marks : 4 Wrong Marks : 1

A capacitor is made of two square plates each of side 'a' making a very small angle α between them, as shown in figure. The capacitance will be close to :

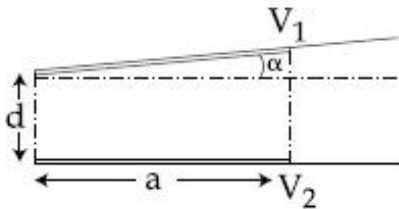

Options :

1. $\frac{\epsilon_0 a^2}{d} \left(1 - \frac{3\alpha a}{2d}\right)$

$$2. \frac{\epsilon_0 a^2}{d} \left(1 - \frac{\alpha a}{2d}\right)$$

$$3. \frac{\epsilon_0 a^2}{d} \left(1 + \frac{\alpha a}{d}\right)$$

$$4. \frac{\epsilon_0 a^2}{d} \left(1 - \frac{\alpha a}{4d}\right)$$

Question Number : 11 Question Type : MCQ Option Shuffling : Yes
Correct Marks : 4 Wrong Marks : 1

एक संधारित्र दो वर्गाकार प्लेटों (आकार $a \times a$) से बना है। प्लेटों के बीच एक बहुत छोटा कोण ' α ' है जैसा कि चित्र में दिखाया गया है। इस संधारित्र की विद्युत धारिता निम्न में से किसके निकटतम होगी?

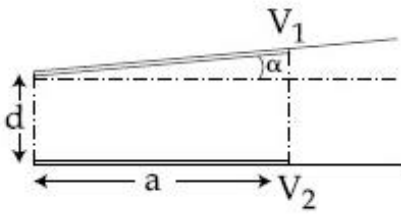

Options :

$$1. \frac{\epsilon_0 a^2}{d} \left(1 - \frac{3\alpha a}{2d}\right)$$

$$2. \frac{\epsilon_0 a^2}{d} \left(1 - \frac{\alpha a}{2d}\right)$$

$$3. \frac{\epsilon_0 a^2}{d} \left(1 + \frac{\alpha a}{d}\right)$$

$$4. \frac{\epsilon_0 a^2}{d} \left(1 - \frac{\alpha a}{4d}\right)$$

Question Number : 11 Question Type : MCQ Option Shuffling : Yes

Correct Marks : 4 Wrong Marks : 1

આકૃતિમાં બતાવ્યા પ્રમાણે એક સંધારક બે ચોરસ તક્તીઓ દ્વારા બનેલ છે, જેની દરેક બાજુ ઓ 'a' છે. આ તક્તીઓ વચ્ચે બનેલો ખૂબ નાનો ખૂણો α છે. સંધારકતા (capacitance) _____ ની નજીક હશે.

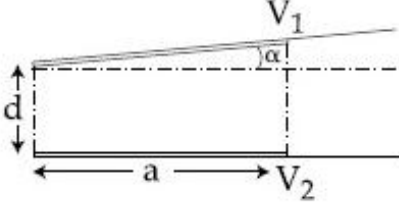

Options :

1. $\frac{\epsilon_0 a^2}{d} \left(1 - \frac{3\alpha a}{2d}\right)$

2. $\frac{\epsilon_0 a^2}{d} \left(1 - \frac{\alpha a}{2d}\right)$

3. $\frac{\epsilon_0 a^2}{d} \left(1 + \frac{\alpha a}{d}\right)$

4. $\frac{\epsilon_0 a^2}{d} \left(1 - \frac{\alpha a}{4d}\right)$

Question Number : 12 Question Type : MCQ Option Shuffling : Yes

Correct Marks : 4 Wrong Marks : 1

A very long wire ABDMNDC is shown in figure carrying current I . AB and BC parts are straight, long and at right angle. At D wire forms a circular turn DMND of radius R . AB, BC parts are tangential to circular turn at N and D. Magnetic field at the centre of circle is :

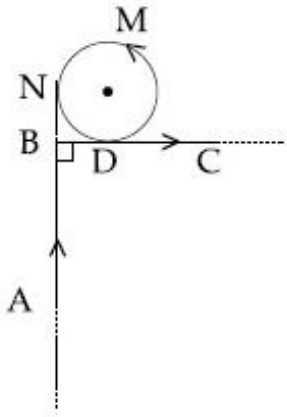

Options :

1. $\frac{\mu_0 I}{2\pi R} \left(\pi + \frac{1}{\sqrt{2}} \right)$

2. $\frac{\mu_0 I}{2\pi R} \left(\pi - \frac{1}{\sqrt{2}} \right)$

3. $\frac{\mu_0 I}{2R}$

4. $\frac{\mu_0 I}{2\pi R} (\pi + 1)$

Question Number : 12 Question Type : MCQ Option Shuffling : Yes
 Correct Marks : 4 Wrong Marks : 1

एक लम्बा तार ABDMNDC चित्र में दिखाया गया है और इसमें विद्युत धारा I बह रही है। इस तार के AB और BC भाग सीधे हैं और एक दूसरे से समकोण बनाते हैं। D पर तार घूमते हुए R त्रिज्या का एक वृत्त DMND बनाता है तथा तार के AB और BC भाग इस वृत्त पर क्रमशः N तथा D पर स्पर्श रेखाएँ बनाते हैं। इस दशा में वृत्त के केन्द्र पर चुम्बकीय क्षेत्र का मान है :

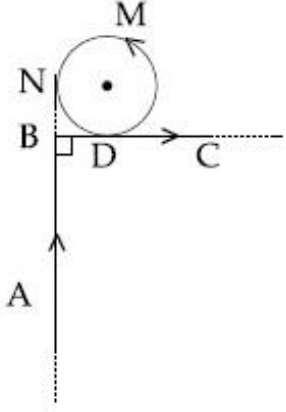

Options :

1. $\frac{\mu_0 I}{2\pi R} \left(\pi + \frac{1}{\sqrt{2}} \right)$

2. $\frac{\mu_0 I}{2\pi R} \left(\pi - \frac{1}{\sqrt{2}} \right)$

3. $\frac{\mu_0 I}{2R}$

4. $\frac{\mu_0 I}{2\pi R} (\pi + 1)$

Question Number : 12 Question Type : MCQ Option Shuffling : Yes
Correct Marks : 4 Wrong Marks : 1

I પ્રવાહ ધરાવતો ખૂબ લાંબો તાર ABDMNDC આકૃતિમાં દર્શાવેલ છે. AB અને BC ભાગો સીધા, લાંબા અને એકબીજાને કાટખુણો છે. D આગળ તાર R ત્રિજ્યા ધરાવતા વર્તુળાકાર DMND માં વળે છે. AB અને BC એ વર્તુળના અનુક્રમે N અને D આગળના સ્પર્શકો છે. ગુંચળાના કેન્દ્ર આગળ ચુંબકીય ક્ષેત્ર _____ છે.

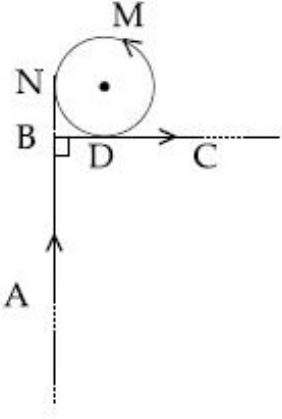

Options :

1. $\frac{\mu_0 I}{2\pi R} \left(\pi + \frac{1}{\sqrt{2}} \right)$

2. $\frac{\mu_0 I}{2\pi R} \left(\pi - \frac{1}{\sqrt{2}} \right)$

3. $\frac{\mu_0 I}{2R}$

4. $\frac{\mu_0 I}{2\pi R} (\pi + 1)$

Question Number : 13 Question Type : MCQ Option Shuffling : Yes

Correct Marks : 4 Wrong Marks : 1

A particle of mass m and charge q is released from rest in a uniform electric field. If there is no other force on the particle, the dependence of its speed v on the distance x travelled by it is correctly given by (graphs are schematic and not drawn to scale)

Options :

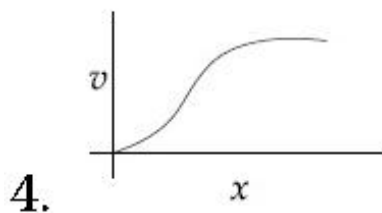
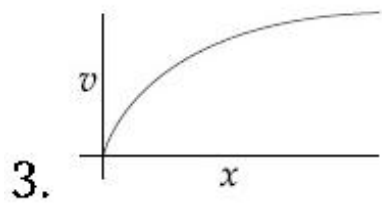
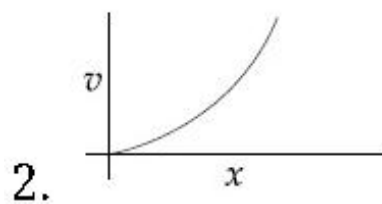
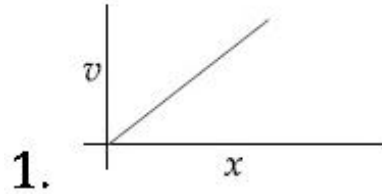

Question Number : 13 Question Type : MCQ Option Shuffling : Yes Correct Marks : 4 Wrong Marks : 1

m द्रव्यमान के एक आवेशित कण, जिस पर आवेश q है, को एकसमान विद्युत क्षेत्र में स्थिर अवस्था से छोड़ा जाता है। यदि इस पर कोई और बल न लग रहा हो तो इसकी गति v तथा इसके द्वारा चली गयी दूरी x में सम्बंध निम्न में से किस ग्राफ द्वारा प्रदर्शित किया जाता है? (ग्राफ संकेतात्मक हैं)

Options :

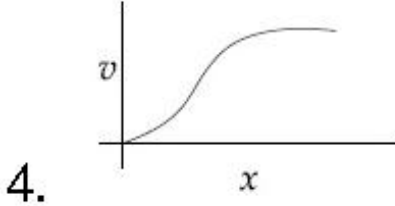
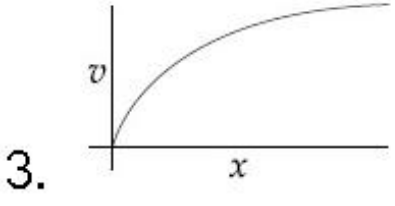
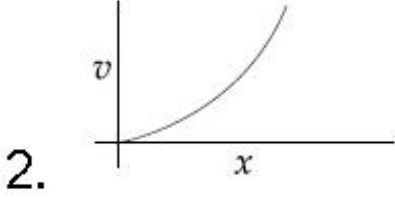
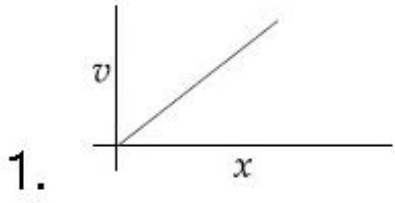

Question Number : 13 Question Type : MCQ Option Shuffling : Yes
Correct Marks : 4 Wrong Marks : 1

m દળ અને v વીજભાર ધરાવતા એક કણને તેની સ્થિર અવસ્થામાંથી નિયમિત વિદ્યુત ક્ષેત્રમાં છોડવામાં આવે છે. જો તેના પર કોઈ બળ ન લાગતું હોય, તો તેની જડપ v અને તેણે કાપેલ અંતર x નો સાચો આલેખ _____ છે. (આલેખ એ એક રેખાકૃતિ છે જે માપ ક્રમમાંનથી)

Options :

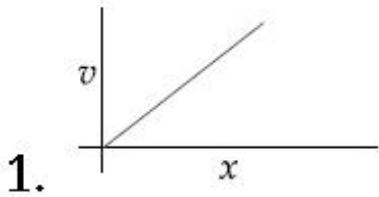

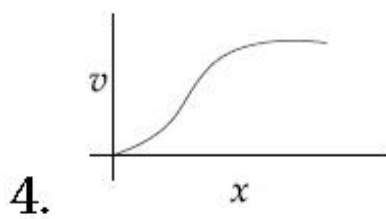
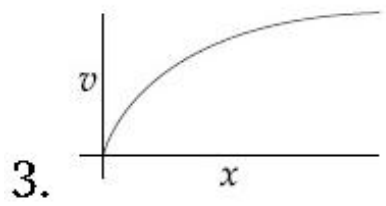
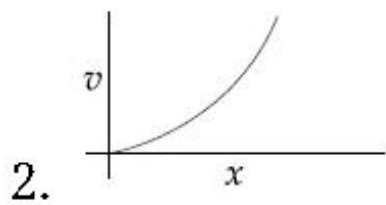

Question Number : 14 Question Type : MCQ Option Shuffling : Yes
 Correct Marks : 4 Wrong Marks : 1

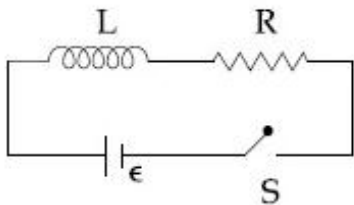

As shown in the figure, a battery of emf ϵ is connected to an inductor L and resistance R in series. The switch is closed at $t=0$. The total charge that flows from the battery, between $t=0$ and $t=t_c$ (t_c is the time constant of the circuit) is :

Options :

1. $\frac{\epsilon L}{eR^2}$

2. $\frac{\epsilon R}{eL^2}$

3. $\frac{\epsilon L}{R^2}$

4. $\frac{\epsilon L}{R^2} \left(1 - \frac{1}{e}\right)$

Question Number : 14 Question Type : MCQ Option Shuffling : Yes
Correct Marks : 4 Wrong Marks : 1

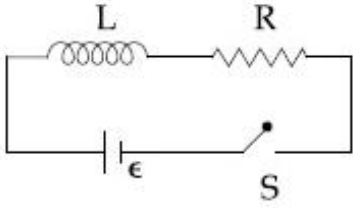

चित्रानुसार विद्युत-वाहक बल ϵ की एक बैटरी को क्रमबद्ध श्रेणी में जोड़कर लगे हुए प्रेरक L तथा प्रतिरोध R से जोड़ा गया है। यदि स्विच को समय $t=0$ पर बन्द कर दिया जाय तो $t=0$ और $t=t_c$ (t_c परिपथ का समय स्थिरांक है) के बीच बैटरी से बहने वाली आवेश का मान है :

Options :

1. $\frac{\epsilon L}{eR^2}$

2. $\frac{\epsilon R}{eL^2}$

3. $\frac{\epsilon L}{R^2}$

4. $\frac{\epsilon L}{R^2} \left(1 - \frac{1}{e}\right)$

Question Number : 14 Question Type : MCQ Option Shuffling : Yes
Correct Marks : 4 Wrong Marks : 1

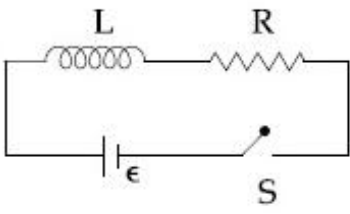

ઇન્ડક્ટર L અને અવરોધ R ને આકૃતિમાં દર્શાવ્યા મુજબ ϵ emf ધરાવતા બેટરી વડે શ્રેણીમાં જોડવામાં આવે છે. $t=0$ એ કળ બંધ કરવામાં આવે છે. $t=0$ અને $t=t_c$ (t_c એ પરીપથનો સમય અચળાંક છે) વચ્ચે બેટરીમાંથી પસાર થતો કુલ વીજભાર _____ છે.

Options :

1. $\frac{\epsilon L}{eR^2}$

2. $\frac{\epsilon R}{eL^2}$

3. $\frac{\epsilon L}{R^2}$

4. $\frac{\epsilon L}{R^2} \left(1 - \frac{1}{e}\right)$

Question Number : 15 Question Type : MCQ Option Shuffling : Yes

Correct Marks : 4 Wrong Marks : 1

A plane electromagnetic wave of frequency 25 GHz is propagating in vacuum along the z-direction. At a particular point in space and time, the magnetic field is given by

$$\vec{B} = 5 \times 10^{-8} \hat{j} \text{ T. The corresponding}$$

electric field \vec{E} is (speed of light $c=3 \times 10^8 \text{ ms}^{-1}$)

Options :

1. $15\hat{i}$ V/m

2. $-15\hat{i}$ V/m

3. $1.66 \times 10^{-16}\hat{i}$ V/m

4. $-1.66 \times 10^{-16}\hat{i}$ V/m

Question Number : 15 Question Type : MCQ Option Shuffling : Yes

Correct Marks : 4 Wrong Marks : 1

25 GHz आवृत्ति की एक समतल विद्युत-चुम्बकीय तरंग निर्वात में z - दिशा में चल रही है। यदि किसी एक समय पर एक स्थान पर तरंग का चुम्बकीय क्षेत्र

$$\vec{B} = 5 \times 10^{-8} \hat{j} \text{ T}$$
 हो तो वहाँ पर उस समय विद्युत

क्षेत्र \vec{E} होगा : (प्रकाश की गति $c = 3 \times 10^8 \text{ ms}^{-1}$)

Options :

1. $15\hat{i}$ V/m

2. $-15\hat{i}$ V/m

3. $1.66 \times 10^{-16}\hat{i}$ V/m

4. $-1.66 \times 10^{-16}\hat{i}$ V/m

Question Number : 15 Question Type : MCQ Option Shuffling : Yes

Correct Marks : 4 Wrong Marks : 1

25 GHz આવૃત્તિ ધરાવતા સમતલ વિદ્યુતચુંબકીય તરંગ શૂન્યાવકાશ માં z- દિશામાં પ્રસરે છે. અવકાશમાં ચોક્કસ બિન્દુ એ અને સમયે, ચુંબકીય ક્ષેત્ર

$\vec{B} = 5 \times 10^{-8} \hat{j} \text{ T}$ આપેલ છે. તેને આનુષંગિક

વિદ્યુત ક્ષેત્ર \vec{E} _____ છે. (પ્રકાશની ઝડપ $c = 3 \times 10^8 \text{ ms}^{-1}$)

Options :

1. $15 \hat{i} \text{ V/m}$

2. $-15 \hat{i} \text{ V/m}$

3. $1.66 \times 10^{-16} \hat{i} \text{ V/m}$

4. $-1.66 \times 10^{-16} \hat{i} \text{ V/m}$

Question Number : 16 Question Type : MCQ Option Shuffling : Yes

Correct Marks : 4 Wrong Marks : 1

An object is gradually moving away from the focal point of a concave mirror along the axis of the mirror. The graphical representation of the magnitude of linear magnification (m) versus distance of the object from the mirror (x) is correctly given by

(Graphs are drawn schematically and are not to scale)

Options :

1.

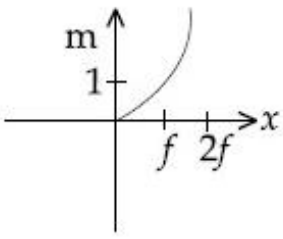

2.

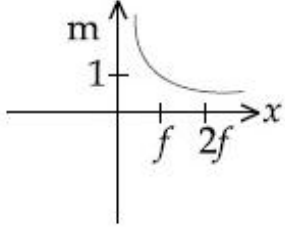

3.

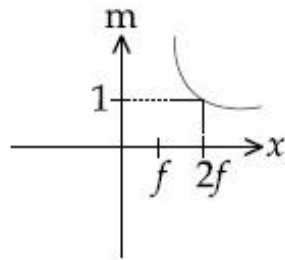

4.

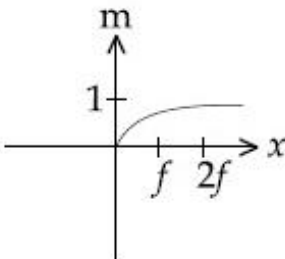

Question Number : 16 Question Type : MCQ Option Shuffling : Yes

Correct Marks : 4 Wrong Marks : 1

एक वस्तु एक अवतल दर्पण के सामने इसके अक्ष पर चलते हुए इसके फोकस से धीरे-धीरे दूर जा रही है। ऐसी अवस्था में निम्न में से कौन सा ग्राफ इस वस्तु के रेखीय आवर्धन (m) के मान का सम्बंध इसके दर्पण से दूरी (x) के साथ दर्शाता है। (ग्राफ संकेतात्मक हैं)

Options :

1.

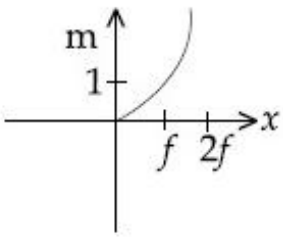

2.

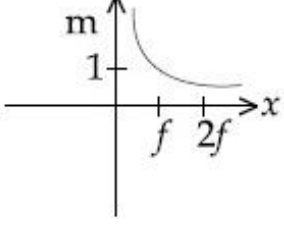

3.

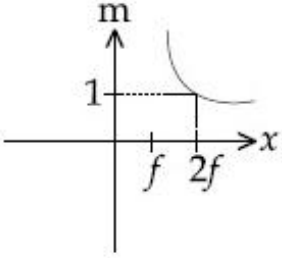

4.

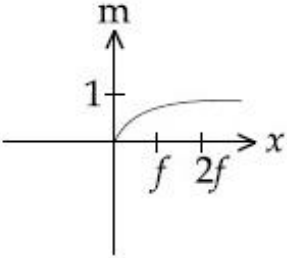

Question Number : 16 Question Type : MCQ Option Shuffling : Yes
Correct Marks : 4 Wrong Marks : 1

અંતર્ગોળ અરીસાની અક્ષને સમાંતર એક વસ્તુને તેના નાભીય બિન્દુ (focal point) થી ધીમે-ધીમે દૂર લઈ જવામાં આવે છે. રેખીય (એક પરિમાણીય) મોટવણીનું માન (m) વિરુદ્ધ અરીસાથી વસ્તુ અંતર (x) નો સાચો આલેખ _____ છે.

(આલેખ એ એક રેખાકૃતિ છે જે માપક્રમમાં નથી)

Options :

1.

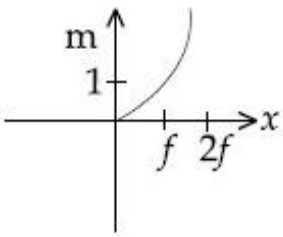

2.

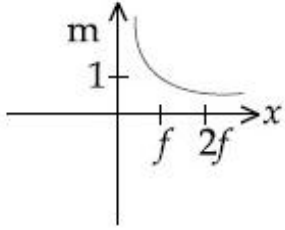

3.

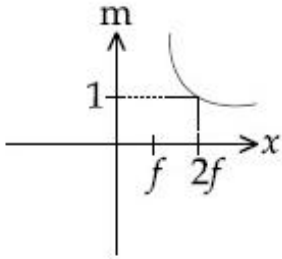

4.

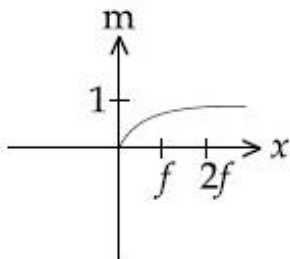

Question Number : 17 Question Type : MCQ Option Shuffling : Yes
 Correct Marks : 4 Wrong Marks : 1

In a double-slit experiment, at a certain point on the screen the path difference

between the two interfering waves is $\frac{1}{8}$ th

of a wavelength. The ratio of the intensity of light at that point to that at the centre of a bright fringe is :

Options :

1. 0.853

2. 0.760

3. 0.672

4. 0.568

Question Number : 17 Question Type : MCQ Option Shuffling : Yes
Correct Marks : 4 Wrong Marks : 1

एक द्वि-झिरी प्रयोग में पर्दे पर एक स्थान पर दो व्यतिकरण करने वाली तरंगों का पथांतर उनके तरंगदैर्घ्य का $\frac{1}{8}$ है। तब इस स्थान पर प्रकाश की तीव्रता का एक चमकीली फ्रिंज के बीच में प्रकाश की तीव्रता से अनुपात होगा :

Options :

1. 0.853

2. 0.760

3. 0.672

4. 0.568

Question Number : 17 Question Type : MCQ Option Shuffling : Yes
Correct Marks : 4 Wrong Marks : 1

યંગના ડબલ સ્લિટના પ્રયોગમાં, પડદા પરના કોણ ચોક્કસ બિન્દુ આગળ વ્યતિકરણ અનુભવતા (interfering) બે તરંગો વચ્ચે પથ તફાવત તેમની તરંગલંબાઈના $\frac{1}{8}$ માં ભાગનો છે. આ બિન્દુ અને મધ્યસ્થ પ્રકાશિત શલાકા ના પ્રકાશ ની તીવ્રતાનો ગુણોત્તર _____ છે.

Options :

1. 0.853

2. 0.760

3. 0.672

4. 0.568

Question Number : 18 Question Type : MCQ Option Shuffling : Yes

Correct Marks : 4 Wrong Marks : 1

An electron (mass m) with initial velocity

$\vec{v} = v_0 \hat{i} + v_0 \hat{j}$ is in an electric field

$\vec{E} = -E_0 \hat{k}$. If λ_0 is initial de-Broglie

wavelength of electron, its de-Broglie wave length at time t is given by :

Options :

1. $\frac{\lambda_0}{\sqrt{1 + \frac{e^2 E_0^2 t^2}{m^2 v_0^2}}}$

$$2. \frac{\lambda_0}{\sqrt{1 + \frac{e^2 E^2 t^2}{2m^2 v_0^2}}}$$

$$3. \frac{\lambda_0}{\sqrt{2 + \frac{e^2 E^2 t^2}{m^2 v_0^2}}}$$

$$4. \frac{\lambda_0 \sqrt{2}}{\sqrt{1 + \frac{e^2 E^2 t^2}{m^2 v_0^2}}}$$

Question Number : 18 Question Type : MCQ Option Shuffling : Yes
Correct Marks : 4 Wrong Marks : 1

एक इलैक्ट्रॉन (द्रव्यमान m) का प्रारंभिक वेग

$\vec{v} = v_0 \hat{i} + v_0 \hat{j}$ है तथा यह एक विद्युत क्षेत्र

$\vec{E} = -E_0 \hat{k}$ में है। यदि इलैक्ट्रॉन की डी-ब्रोग्ली तरंग का प्रारंभिक तरंगदैर्घ्य λ_0 हो तो t समय के पश्चात इसका तरंगदैर्घ्य होगा :

Options :

$$1. \frac{\lambda_0}{\sqrt{1 + \frac{e^2 E_0^2 t^2}{m^2 v_0^2}}}$$

$$2. \frac{\lambda_0}{\sqrt{1 + \frac{e^2 E^2 t^2}{2m^2 v_0^2}}}$$

3.
$$\frac{\lambda_0}{\sqrt{2 + \frac{e^2 E^2 t^2}{m^2 v_0^2}}}$$

4.
$$\frac{\lambda_0 \sqrt{2}}{\sqrt{1 + \frac{e^2 E^2 t^2}{m^2 v_0^2}}}$$

Question Number : 18 Question Type : MCQ Option Shuffling : Yes
Correct Marks : 4 Wrong Marks : 1

એક ઇલેક્ટ્રોન (દળ m) વિદ્યુત ક્ષેત્ર $\vec{E} = -E_0 \hat{k}$ માં

પ્રારંભિક વેગ $\vec{v} = v_0 \hat{i} + v_0 \hat{j}$ સાથે રહેલ છે. જો λ_0 એ ઇલેક્ટ્રોનની પ્રારંભિક ડી-બ્રોગ્લી તરંગલંબાઈ હોય તો સમય t એ તેની ડી-બ્રોગ્લી તરંગલંબાઈ _____ છે.

Options :

1.
$$\frac{\lambda_0}{\sqrt{1 + \frac{e^2 E_0^2 t^2}{m^2 v_0^2}}}$$

2.
$$\frac{\lambda_0}{\sqrt{1 + \frac{e^2 E^2 t^2}{2m^2 v_0^2}}}$$

3.
$$\frac{\lambda_0}{\sqrt{2 + \frac{e^2 E^2 t^2}{m^2 v_0^2}}}$$

$$4. \frac{\lambda_0 \sqrt{2}}{\sqrt{1 + \frac{e^2 E^2 t^2}{m^2 v_0^2}}}$$

Question Number : 19 Question Type : MCQ Option Shuffling : Yes
 Correct Marks : 4 Wrong Marks : 1
 In the given circuit, value of Y is :

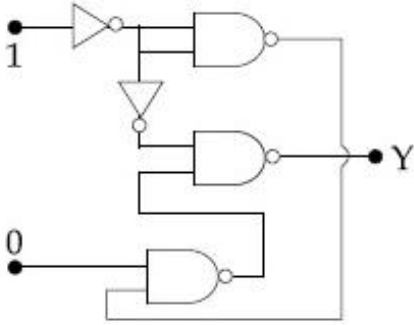

Options :

1. 0
2. 1
3. toggles between 0 and 1
4. will not execute

Question Number : 19 Question Type : MCQ Option Shuffling : Yes
 Correct Marks : 4 Wrong Marks : 1

दिये गये परिपथ में Y का मान है :

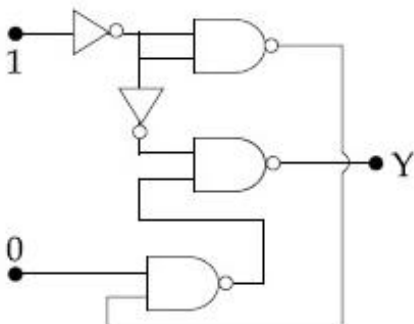

Options :

1. 0
2. 1
3. 0 और 1 बीच में घटता-बढ़ता
4. परिपथ कार्यान्वित नहीं होगा

Question Number : 19 Question Type : MCQ Option Shuffling : Yes
Correct Marks : 4 Wrong Marks : 1

परिપથમાં Y નું મૂલ્ય _____ છે.

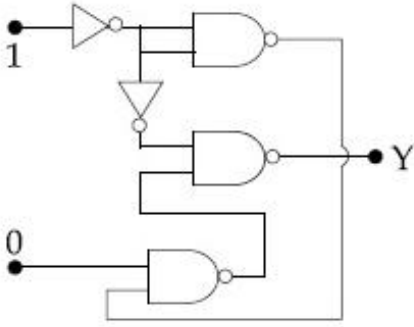

Options :

1. 0
2. 1
3. 0 અને 1 ની વચ્ચે સતત બદલાયા કરે છે.
4. પરિપથ કાર્યરત થશે નહીં

Question Number : 20 Question Type : MCQ Option Shuffling : Yes

Correct Marks : 4 Wrong Marks : 1

A galvanometer having a coil resistance 100Ω gives a full scale deflection when a current of 1 mA is passed through it. What is the value of the resistance which can convert this galvanometer into a voltmeter giving full scale deflection for a potential difference of 10 V ?

Options :

1. $8.9 \text{ k}\Omega$
2. $9.9 \text{ k}\Omega$
3. $7.9 \text{ k}\Omega$
4. $10 \text{ k}\Omega$

Question Number : 20 Question Type : MCQ Option Shuffling : Yes

Correct Marks : 4 Wrong Marks : 1

एक गैल्वेनोमापी की कुंडली का प्रतिरोध 100Ω है तथा इसमें से 1 mA विद्युत धारा बहने पर यह पूरी तरह से विक्षेपित हो जाता है। यदि इसे एक ऐसे वोल्टमापी में बदलना हो जो 10 V विभवान्तर लगाने पर पूरा विक्षेपित हो जाय तो इस पर लगाये जाने वाले प्रतिरोध का मान होगा :

Options :

1. $8.9 \text{ k}\Omega$
2. $9.9 \text{ k}\Omega$
3. $7.9 \text{ k}\Omega$

4. 10 k Ω

Question Number : 20 Question Type : MCQ Option Shuffling : Yes

Correct Marks : 4 Wrong Marks : 1

100 Ω ગર્ભ (core) નો અવરોધ ધરાવતા એક ગેલ્વેનોમીટર માંથી જ્યારે 1 mA પ્રવાહ પસાર કરવામાં આવે છે ત્યારે તેમાં પૂર્ણ સ્કેલ આવર્તન મળે છે. ગેલ્વેનોમીટરમાંથી 10 V વીજસ્થિતિમાન ના તફાવત માટે પૂર્ણ સ્કેલ આવર્તન આપે તેવું વોલ્ટમીટર બનવવામાટે જરૂરી અવરોધનું મૂલ્ય કેટલું હશે ?

Options :

1. 8.9 k Ω

2. 9.9 k Ω

3. 7.9 k Ω

4. 10 k Ω

Sub-Section Number:

2

Sub-Section Id:

405036105

Question Shuffling Allowed :

Yes

Question Number : 21 Question Type : SA

Correct Marks : 4 Wrong Marks : 0

A ball is dropped from the top of a 100 m

high tower on a planet. In the last $\frac{1}{2}$ s

before hitting the ground, it covers a distance of 19 m. Acceleration due to gravity (in ms^{-2}) near the surface on that planet is _____.

Note: For this question, discrepancy is found in question/answer. So, this question is ignored for all candidates.

Response Type: Numeric

Evaluation Required For SA: Yes

Show Word Count: Yes

Answers Type: Range

Possible Answers :

1 to 2.01

Question Number : 21 Question Type : SA

Correct Marks : 4 Wrong Marks : 0

एक ग्रह पर 100 मीटर ऊँचे एक स्तम्भ के ऊपर से एक गेंद को छोड़ा जाता है। धरातल पर टकराने से पहले के

$\frac{1}{2}$ s में यह गेंद 19 m की दूरी तय करती है। इस ग्रह

पर गुरुत्वाकर्षण के कारण त्वरण का मान (ms^{-2} में) है _____।

Note: For this question, discrepancy is found in question/answer. So, this question is ignored for all candidates.

Response Type: Numeric

Evaluation Required For SA: Yes

Show Word Count: Yes

Answers Type: Range

Possible Answers :

1 to 2.01

Question Number : 21 Question Type : SA

Correct Marks : 4 Wrong Marks : 0

એક અજ્ઞાત ગ્રહ પર આવેલ 100 m ઉંચા ટાવરની ટોચ પરથી એક દળને છોડવામાં આવે છે. જમીનને

અડચા પહેલાની $\frac{1}{2}$ s માં એ 19 m અંતર કાપે છે.

ગ્રહની સપાટી નજીક ગુરુત્વપ્રવેગ (ms^{-2} માં) _____ છે.

Note: For this question, discrepancy is found in question/answer. So, this question is ignored for all candidates.

Response Type: Numeric

Evaluation Required For SA: Yes

Show Word Count: Yes

Answers Type: Range

Possible Answers :

1 to 2.01

Question Number : 22 Question Type : SA

Correct Marks : 4 Wrong Marks : 0

An asteroid is moving directly towards the centre of the earth. When at a distance of $10R$ (R is the radius of the earth) from the earth's centre, it has a speed of 12 km/s . Neglecting the effect of earth's atmosphere, what will be the speed of the asteroid when it hits the surface of the earth (escape velocity from the earth is 11.2 km/s)? Give your answer to the nearest integer in kilometer/s _____.

Response Type: Numeric

Evaluation Required For SA: Yes

Show Word Count: Yes

Answers Type: Range

Possible Answers :

16 to 16

Question Number : 22 **Question Type :** SA

Correct Marks : 4 **Wrong Marks :** 0

एक क्षुद्रग्रह (asteroid) पृथ्वी के केन्द्र से $10R$ (R पृथ्वी की त्रिज्या है) दूरी पर है और पृथ्वी के केन्द्र की ओर 12 km/s गति से आ रहा है। यदि पृथ्वी से पलायन गति का मान 11.2 kms^{-1} है तो पृथ्वी के वातावरण के प्रभाव को नगण्य मानते हुए इस क्षुद्रग्रह की पृथ्वी की सतह से टकराते समय गति कितनी होगी? (अपना उत्तर kms^{-1} में निकटतम पूर्णांक में दें) _____।

Response Type: Numeric

Evaluation Required For SA: Yes

Show Word Count: Yes

Answers Type: Range

Possible Answers :

16 to 16

Question Number : 22 **Question Type :** SA

Correct Marks : 4 **Wrong Marks :** 0

ક્ષુદ્ર ગ્રહ (asteroid) પૃથ્વીના કેન્દ્ર તરફ ગતિ કરે છે. પૃથ્વીના કેન્દ્રથી એ જ્યારે $10R$ જેટલા અંતરે છે (R એ પૃથ્વી ની ત્રિજ્યા છે) ત્યારે તેની ઝડપ 12 km/s છે. જ્યારે એ પૃથ્વીની સપાટીને સ્પર્શે છે ત્યારે ક્ષુદ્રગ્રહ ની ઝડપ કેટલી હશે? અહીં પૃથ્વીના વાતાવરણ ની અસરને અવગણો. (પૃથ્વીનો નિષ્ક્રમણ (escape) વેગ 11.2 kms^{-1} છે) તમારો જવાબ કિલોમીટર/સે _____ ની નજીકના પૂર્ણાંકમાં આપો.

Response Type: Numeric

Evaluation Required For SA: Yes

Show Word Count: Yes

Answers Type: Range

Possible Answers :

16 to 16

Question Number : 23 Question Type : SA

Correct Marks : 4 Wrong Marks : 0

Three containers C_1 , C_2 and C_3 have water at different temperatures. The table below shows the final temperature T when different amounts of water (given in liters) are taken from each container and mixed (assume no loss of heat during the process)

C_1	C_2	C_3	T
1l	2l	--	60°C
--	1l	2l	30°C
2l	--	1l	60°C
1l	1l	1l	θ

The value of θ (in °C to the nearest integer) is _____.

Response Type: Numeric

Evaluation Required For SA: Yes

Show Word Count: Yes

Answers Type: Range

Possible Answers :

50 to 50

Question Number : 23 Question Type : SA

Correct Marks : 4 Wrong Marks : 0

C_1 , C_2 तथा C_3 तीन पात्र (Containers) हैं जिनमें भिन्न-भिन्न तापमानों पर पानी रखा हुआ है। जब इन पात्रों से अलग-अलग मात्राओं में पानी लेकर मिलाया जाता है तो इस मिश्रण का अन्तिम तापमान T हो जाता है। पात्रों से लिये गये पानी की मात्रा (लीटर में) और तापमान T का मान नीचे तालिका में दिया हुआ है। (यह माने कि मिश्रित करने की प्रक्रिया में ऊष्मा का क्षय नहीं हुआ है)

C_1	C_2	C_3	T
1l	2l	--	60°C
--	1l	2l	30°C
2l	--	1l	60°C
1l	1l	1l	θ

θ के मान ($^{\circ}\text{C}$ में) के निकटतम पूर्णांक है _____।

Response Type: Numeric

Evaluation Required For SA: Yes

Show Word Count: Yes

Answers Type: Range

Possible Answers :

50 to 50

Question Number : 23 **Question Type :** SA

Correct Marks : 4 **Wrong Marks :** 0

જુદા-જુદા તાપમાને ત્રણ પાત્રો C_1 , C_2 અને C_3 માં પાણી ભરેલું છે. જ્યારે જુદા-જુદા પ્રમાણમાં દરેક પાત્રમાંથી પાણી (લીટરમાં) લેવામાં આવે છે અને તેને ભેળવવામાં આવે છે ત્યારનું અંતિમ તાપમાન નીચેના ટેબલમાં આપેલ છે. (એવું ધારો લો કે પ્રક્રિયા દરમિયાન ઉર્જાનો વ્યય થતો નથી)

C_1	C_2	C_3	T
1l	2l	--	60°C
--	1l	2l	30°C
2l	--	1l	60°C
1l	1l	1l	θ

θ નું મૂલ્ય (નજીકના પૂર્ણાંકમાં $^{\circ}\text{C}$ માં) _____ છે.

Response Type: Numeric

Evaluation Required For SA: Yes

Show Word Count: Yes

Answers Type: Range

Possible Answers :

50 to 50

Question Number : 24 Question Type : SA

Correct Marks : 4 Wrong Marks : 0

The series combination of two batteries, both of the same emf 10 V, but different internal resistance of 20Ω and 5Ω , is connected to the parallel combination of two resistors 30Ω and $R \Omega$. The voltage difference across the battery of internal resistance 20Ω is zero, the value of R (in Ω) is _____.

Response Type: Numeric

Evaluation Required For SA: Yes

Show Word Count: Yes

Answers Type: Range

Possible Answers :

30 to 30

Question Number : 24 Question Type : SA

Correct Marks : 4 Wrong Marks : 0

क्रमबद्ध श्रेणी में जोड़ी हुई दो बैटरियों को पार्श्व सम्बंधन (parallel connection) में जुड़े दो प्रतिरोधक तारों से जोड़ा गया है। दोनों बैटरियों का विद्युत वाहक बल 10 V है पर उनकी आंतरिक प्रतिरोधकता 20Ω और 5Ω है। तारों के प्रतिरोध 30Ω और $R \Omega$ हैं। ऐसी दशा में यदि 20Ω आंतरिक प्रतिरोध वाली बैटरी के टर्मिनलों का विभवान्तर शून्य हो तो R (Ω में) का मान है _____।

Response Type: Numeric

Evaluation Required For SA: Yes

Show Word Count: Yes

Answers Type: Range

Possible Answers :

30 to 30

Question Number : 24 Question Type : SA

Correct Marks : 4 Wrong Marks : 0

10 V સમાન emf પરંતુ 20Ω અને 5Ω જુદા-જુદા આંતરિક અવરોધ ધરાવતી બે બેટરીઓ (વિદ્યુતકોષો) ના શ્રેણી સંયોજન ને 30Ω અને $R \Omega$ ના બે અવરોધના સમાંતર સંયોજન સાથે જોડવામાં આવે છે. જો 20Ω આંતરિક અવરોધ ધરાવતી બેટરીને સમાંતર વીજસ્થિતિમાનનો તફાવત શૂન્ય હોય તો, R નું મૂલ્ય (Ω માં) _____ છે.

Response Type: Numeric

Evaluation Required For SA: Yes

Show Word Count: Yes

Answers Type: Range

Possible Answers :

30 to 30

Question Number : 25 Question Type : SA

Correct Marks : 4 Wrong Marks : 0

The first member of the Balmer series of hydrogen atom has a wavelength of 6561 Å. The wavelength of the second member of the Balmer series (in nm) is _____.

Response Type: Numeric

Evaluation Required For SA: Yes

Show Word Count: Yes

Answers Type: Range

Possible Answers :

486 to 486

Question Number : 25 Question Type : SA

Correct Marks : 4 Wrong Marks : 0

हाइड्रोजन परमाणु की बामर श्रृंखला के पहले घटक का तरंगदैर्घ्य 6561 Å है। तब बामर श्रृंखला के दूसरे घटक का तरंगदैर्घ्य nm में होगा _____।

Response Type: Numeric

Evaluation Required For SA: Yes

Show Word Count: Yes

Answers Type: Range

Possible Answers :

486 to 486

Question Number : 25 Question Type : SA

Correct Marks : 4 Wrong Marks : 0

હાઇડ્રોજન પરમાણુની બામર શ્રેણી ના પ્રથમ સભ્ય (ઘટક) ની તરંગલંબાઈ 6561 Å છે. બામર શ્રેણીની બીજા સભ્યની તરંગલંબાઈ nm _____ છે.

Response Type: Numeric

Evaluation Required For SA: Yes

Show Word Count: Yes

Answers Type: Range

Possible Answers :

486 to 486

Chemistry

Section Id :

40503667

Section Number :

2

Section type :

Online

Mandatory or Optional:

Mandatory

Number of Questions:

25

Number of Questions to be attempted:

25

Sub-Section Number: 1
Sub-Section Id: 405036106
Question Shuffling Allowed : Yes

Question Number : 26 Question Type : MCQ Option Shuffling : Yes
Correct Marks : 4 Wrong Marks : 1

For the following Assertion and Reason,
the correct option is :

Assertion : For hydrogenation reactions,
the catalytic activity increases
from Group 5 to Group 11
metals with maximum activity
shown by Group 7-9 elements.

Reason : The reactants are most strongly
adsorbed on group 7 - 9
elements.

Options :

1. Both assertion and reason are true
and the reason is the correct
explanation for the assertion.
2. Both assertion and reason are true but
the reason is not the correct
explanation for the assertion.
3. The assertion is true, but the reason
is false.
4. Both assertion and reason are false.

Question Number : 26 Question Type : MCQ Option Shuffling : Yes
Correct Marks : 4 Wrong Marks : 1

निम्न कथन तथा कारण के लिए सही विकल्प है :

कथन : हाइड्रोजनीकरण अभिक्रिया के लिए, उत्प्रेरित क्रियाशीलता समूह 5 से समूह 11 तक बढ़ती है जिसमें समूह 7-9 के तत्वों में सबसे अधिक क्रियाशीलता होती है।

कारण : समूह 7 - 9 के तत्वों पर अभिकारकों का अधिशोषण सर्वाधिक प्रबलता से होता है।

Options :

कथन तथा कारण दोनों सही हैं तथा कारण कथन

1. की सही व्याख्या है।

कथन तथा कारण दोनों सही हैं परन्तु कारण

2. कथन की सही व्याख्या नहीं है।

3. कथन सही है, परन्तु कारण गलत है।

4. कथन तथा कारण दोनों गलत हैं।

Question Number : 26 Question Type : MCQ Option Shuffling : Yes

Correct Marks : 4 Wrong Marks : 1

નીચે આપેલા કથન અને કારણ માટે નીચે આપેલા પૈકી કયું એક સાચું છે ?

કથન : હાઈડ્રોજનેશન પ્રક્રિયા માટે, ઉદ્દીપકીય સક્રિયતા સમૂહ 5 થી સમૂહ 11 ની ધાતુઓમાં વધે છે અને સૌથી વધુ સક્રિયતા 7-9 ના તત્વોમાં જોવા મળે છે.

કારણ : સમૂહ 7 - 9 ના તત્વો ઉપર પ્રક્રિયકોનું સૌથી પ્રબળ અધિશોષણ થાય છે.

Options :

કથન અને કારણ બંને સાચા છે અને કારણ એ

1. કથન માટેની સાચી સમજૂતી છે.

કથન અને કારણ બંને સાચા છે પરંતુ કારણ એ

2. કથન માટેની સાચી સમજૂતી નથી.

3. કથન સાચું છે પરંતુ કારણ ખોટું છે.

4. કથન અને કારણ બંને ખોટાં છે.

Question Number : 27 Question Type : MCQ Option Shuffling : Yes

Correct Marks : 4 Wrong Marks : 1

Consider the following plots of rate

constant versus $\frac{1}{T}$ for four different

reactions. Which of the following orders is correct for the activation energies of these reactions ?

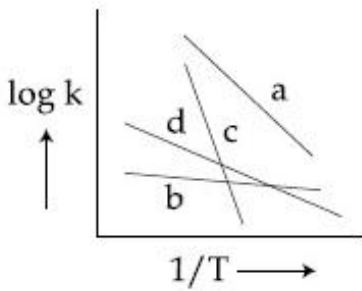

Options :

1. $E_b > E_d > E_c > E_a$

2. $E_a > E_c > E_d > E_b$

3. $E_c > E_a > E_d > E_b$

4. $E_b > E_a > E_d > E_c$

Question Number : 27 Question Type : MCQ Option Shuffling : Yes

Correct Marks : 4 Wrong Marks : 1

चार विभिन्न अभिक्रियाओं के लिए वेग-स्थिरांक का

$\frac{1}{T}$ के विरुद्ध निम्नलिखित आलेखों पर विचार कीजिए।

इन अभिक्रियाओं के सक्रियण ऊर्जाओं के लिए निम्नलिखित क्रमों में से कौन सा सही है?

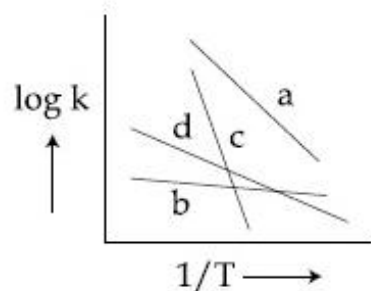

Options :

1. $E_b > E_d > E_c > E_a$

2. $E_a > E_c > E_d > E_b$

3. $E_c > E_a > E_d > E_b$

4. $E_b > E_a > E_d > E_c$

Question Number : 27 Question Type : MCQ Option Shuffling : Yes

Correct Marks : 4 Wrong Marks : 1

ચાર ભિન્ન પ્રક્રિયાઓ માટે, દર અચળાંક વિરુદ્ધ $\frac{1}{T}$ નો આલેખ ધ્યાનમાં લો. આ પ્રક્રિયાઓની સક્રિયકરણ શક્તિઓનો સાચો ક્રમ નીચેના માંથી કયો?

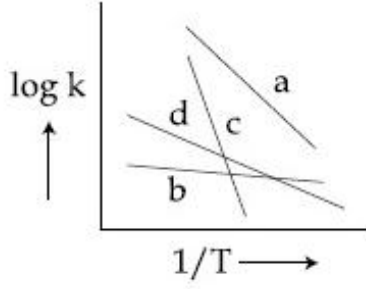

Options :

1. $E_b > E_d > E_c > E_a$
2. $E_a > E_c > E_d > E_b$
3. $E_c > E_a > E_d > E_b$
4. $E_b > E_a > E_d > E_c$

Question Number : 28 Question Type : MCQ Option Shuffling : Yes

Correct Marks : 4 Wrong Marks : 1

For the following Assertion and Reason, the correct option is :

Assertion : The pH of water increases with increase in temperature.

Reason : The dissociation of water into H^+ and OH^- is an exothermic reaction.

Options :

Both assertion and reason are true, and the reason is the correct

1. explanation for the assertion.

Both assertion and reason are true, but the reason is not the correct explanation for the assertion.

Assertion is not true, but reason is true.

Both assertion and reason are false.

Question Number : 28 Question Type : MCQ Option Shuffling : Yes
Correct Marks : 4 Wrong Marks : 1

निम्नलिखित कथन तथा कारण के लिए सही विकल्प है :

कथन : जल का pH ताप के बढ़ने से बढ़ता है।

कारण : जल का H^+ तथा OH^- में वियोजन एक ऊष्मा-क्षेपी अभिक्रिया है।

Options :

कथन तथा कारण दोनों सही हैं, तथा कारण कथन की सही व्याख्या है।

कथन तथा कारण दोनों सही हैं, परन्तु कारण कथन की सही व्याख्या नहीं है।

कथन गलत है, परन्तु कारण सही है।

कथन तथा कारण दोनों गलत हैं।

Question Number : 28 Question Type : MCQ Option Shuffling : Yes
Correct Marks : 4 Wrong Marks : 1

નીચે કથન અને કારણ આપેલા છે. સાચો વિકલ્પ શોધો.

કથન : તાપમાન વધવાની સાથે પાણીની pH વધે છે.

કારણ : પાણીનું H^+ અને OH^- માં થતું વિયોજન એ એક ઉષ્માક્ષેપક પ્રક્રિયા છે.

Options :

1. કથન અને કારણ બંને સાચા છે અને કારણ એ કથનની સાચી સમજૂતી છે.
2. કથન અને કારણ બંને સાચા છે પરંતુ કારણ એ કથનની સાચી સમજૂતી છે.
3. કથન સાચું નથી પરંતુ કારણ સાચું છે.
4. કથન અને કારણ બંને ખોટાં છે.

Question Number : 29 Question Type : MCQ Option Shuffling : Yes
Correct Marks : 4 Wrong Marks : 1

The radius of the second Bohr orbit, in terms of the Bohr radius, a_0 , in Li^{2+} is :

Options :

1. $\frac{2a_0}{3}$
2. $\frac{4a_0}{3}$
3. $\frac{2a_0}{9}$

4. $\frac{4a_0}{9}$

Question Number : 29 Question Type : MCQ Option Shuffling : Yes
Correct Marks : 4 Wrong Marks : 1

Li^{2+} में द्वितीय बोर-कक्षक की त्रिज्या, बोर त्रिज्या,
 a_0 के रूप में, है :

Options :

1. $\frac{2a_0}{3}$

2. $\frac{4a_0}{3}$

3. $\frac{2a_0}{9}$

4. $\frac{4a_0}{9}$

Question Number : 29 Question Type : MCQ Option Shuffling : Yes
Correct Marks : 4 Wrong Marks : 1

बोहर त्रिज्या a_0 ना संदर्भ मां, Li^{2+} बीछ बोहर
कक्षानी त्रिज्या छे.

Options :

1. $\frac{2a_0}{3}$

2. $\frac{4a_0}{3}$

3. $\frac{2a_0}{9}$

4. $\frac{4a_0}{9}$

Question Number : 30 Question Type : MCQ Option Shuffling : Yes

Correct Marks : 4 Wrong Marks : 1

Arrange the following bonds according to their average bond energies in descending order :

C - Cl, C - Br, C - F, C - I

Options :

1. C - Cl > C - Br > C - I > C - F

2. C - F > C - Cl > C - Br > C - I

3. C - I > C - Br > C - Cl > C - F

4. C - Br > C - I > C - Cl > C - F

Question Number : 30 Question Type : MCQ Option Shuffling : Yes

Correct Marks : 4 Wrong Marks : 1

निम्नलिखित आबंधों को उनके औसत आबंध ऊर्जाओं के अनुसार घटते क्रम में क्रमबद्ध कीजिए :

C - Cl, C - Br, C - F, C - I

Options :

1. C - Cl > C - Br > C - I > C - F

2. C - F > C - Cl > C - Br > C - I

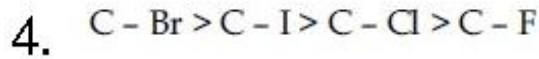
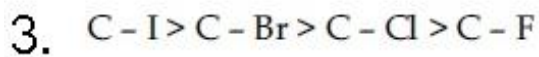

Question Number : 30 Question Type : MCQ Option Shuffling : Yes

Correct Marks : 4 Wrong Marks : 1

નીચે આપેલા બંધોને તેમની સરેરાશ બંધ ઉર્જાના ઉતરતા

ક્રમમાં ગોઠવો :

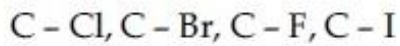

Options :

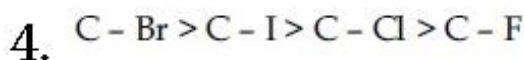
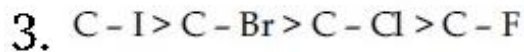
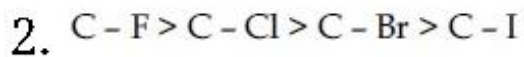
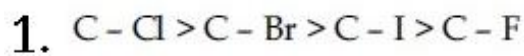

Question Number : 31 Question Type : MCQ Option Shuffling : Yes

Correct Marks : 4 Wrong Marks : 1

Which of the following compounds is likely to show both Frenkel and Schottky defects in its crystalline form ?

Options :

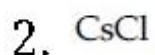
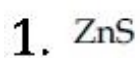

3. KBr

4. AgBr

Question Number : 31 Question Type : MCQ Option Shuffling : Yes

Correct Marks : 4 Wrong Marks : 1

निम्नलिखित यौगिकों में से कौन अपने क्रिस्टलीय रूप में फ्रेन्केल तथा शॉटकी दोनों दोषों को प्रदर्शित करता है?

Options :

1. ZnS

2. CsCl

3. KBr

4. AgBr

Question Number : 31 Question Type : MCQ Option Shuffling : Yes

Correct Marks : 4 Wrong Marks : 1

इसदीर्घीय इपमां नीथेना संयोजनोमानो कयो इन्डल अने शोटकी अे अंने त्रुटिओ द्दशावे छे?

Options :

1. ZnS

2. CsCl

3. KBr

4. AgBr

Question Number : 32 Question Type : MCQ Option Shuffling : Yes
Correct Marks : 4 Wrong Marks : 1

The increasing order of the atomic radii of
the following elements is :

- (a) C (b) O (c) F
(d) Cl (e) Br

Options :

1. (a) < (b) < (c) < (d) < (e)

2. (b) < (c) < (d) < (a) < (e)

3. (c) < (b) < (a) < (d) < (e)

4. (d) < (c) < (b) < (a) < (e)

Question Number : 32 Question Type : MCQ Option Shuffling : Yes
Correct Marks : 4 Wrong Marks : 1

निम्नलिखित तत्वों की परमाणु त्रिज्याओं का बढ़ता क्रम
है :

- (a) C (b) O (c) F
(d) Cl (e) Br

Options :

1. (a) < (b) < (c) < (d) < (e)

2. (b) < (c) < (d) < (a) < (e)

3. $(c) < (b) < (a) < (d) < (e)$

4. $(d) < (c) < (b) < (a) < (e)$

Question Number : 32 Question Type : MCQ Option Shuffling : Yes
Correct Marks : 4 Wrong Marks : 1

નીચે આપેલા તત્વોની પરમાણ્વીય ત્રિજ્યાનો ચઢતો ક્રમ છે :

- (a) C (b) O (c) F
(d) Cl (e) Br

Options :

1. $(a) < (b) < (c) < (d) < (e)$

2. $(b) < (c) < (d) < (a) < (e)$

3. $(c) < (b) < (a) < (d) < (e)$

4. $(d) < (c) < (b) < (a) < (e)$

Question Number : 33 Question Type : MCQ Option Shuffling : Yes
Correct Marks : 4 Wrong Marks : 1

Among the reactions (a) - (d), the reaction(s) that does/do not occur in the blast furnace during the extraction of iron is/are :

- (a) $\text{CaO} + \text{SiO}_2 \rightarrow \text{CaSiO}_3$
(b) $3\text{Fe}_2\text{O}_3 + \text{CO} \rightarrow 2\text{Fe}_3\text{O}_4 + \text{CO}_2$
(c) $\text{FeO} + \text{SiO}_2 \rightarrow \text{FeSiO}_3$
(d) $\text{FeO} \rightarrow \text{Fe} + \frac{1}{2}\text{O}_2$

Options :

1. (a)

2. (d)

3. (c) and (d)

4. (a) and (d)

Question Number : 33 Question Type : MCQ Option Shuffling : Yes

Correct Marks : 4 Wrong Marks : 1

अभिक्रियाओं (a) - (d), में से वात्याभट्टी में आयरन के निष्कर्षण के दौरान नहीं घटित होने वाली अभिक्रिया/अभिक्रियायें है/हैं :

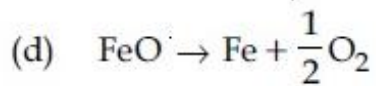
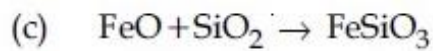
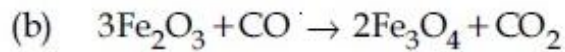
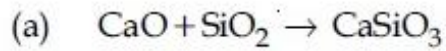

Options :

1. (a)

2. (d)

3. (c) तथा (d)

4. (a) तथा (d)

Question Number : 33 Question Type : MCQ Option Shuffling : Yes

Correct Marks : 4 Wrong Marks : 1

આપેલી પ્રક્રિયાઓ (a) - (d) પૈકી, પ્રક્રિયા (ઓ) કે જે આયર્નના નિષ્કર્ષણ દરિમ્યાન વાત ભટ્ટીમાં થાય છે/થતી નથી તે/તેઓ :

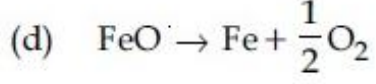
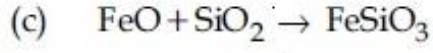
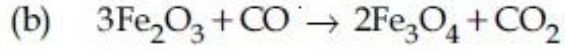
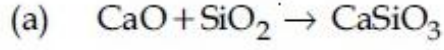

Options :

1. (a)

2. (d)

3. (c) અને (d)

4. (a) અને (d)

Question Number : 34 Question Type : MCQ Option Shuffling : Yes

Correct Marks : 4 Wrong Marks : 1

Hydrogen has three isotopes (A), (B) and (C). If the number of neutron(s) in (A), (B) and (C) respectively, are (x), (y) and (z), the sum of (x), (y) and (z) is :

Options :

1. 1

2. 2

3. 3

4. 4

Question Number : 34 Question Type : MCQ Option Shuffling : Yes
Correct Marks : 4 Wrong Marks : 1

हाइड्रोजन के तीन समस्थानिक (A), (B) तथा (C) हैं।
यदि (A), (B) तथा (C) के न्यूट्रॉनों की संख्या क्रमशः
(x), (y) तथा (z) हैं तो (x), (y) तथा (z) का योग है :

Options :

1. 1

2. 2

3. 3

4. 4

Question Number : 34 Question Type : MCQ Option Shuffling : Yes
Correct Marks : 4 Wrong Marks : 1

હાઈડ્રોજનના ત્રણ સમસ્થાનિકો (A), (B) અને (C) છે.
(A), (B) અને (C) માં ન્યુટ્રોન ની સંખ્યા અનુક્રમે
(x), (y) અને (z) હોય તો (x), (y) અને (z) નો સરવાળો
છે :

Options :

1. 1

2. 2

3. 3

4. 4

Question Number : 35 Question Type : MCQ Option Shuffling : Yes
Correct Marks : 4 Wrong Marks : 1

A metal (A) on heating in nitrogen gas gives compound B. B on treatment with H_2O gives a colourless gas which when passed through $CuSO_4$ solution gives a dark blue-violet coloured solution. A and B respectively, are :

Options :

1. Na and Na_3N
2. Mg and Mg_3N_2
3. Mg and $Mg(NO_3)_2$
4. Na and $NaNO_3$

Question Number : 35 Question Type : MCQ Option Shuffling : Yes
Correct Marks : 4 Wrong Marks : 1

एक धातु (A) नाइट्रोजन गैस में गरम करने पर यौगिक B देता है। B, H_2O के साथ उपचारित करने पर एक रंगहीन गैस देता है जिसको $CuSO_4$ के विलयन से प्रवाहित करने पर एक गहरे नीले-बैंगनी रंग का विलयन देता है। A तथा B क्रमशः हैं :

Options :

1. Na तथा Na_3N
2. Mg तथा Mg_3N_2

3. Mg તથા $Mg(NO_3)_2$

4. Na તથા $NaNO_3$

Question Number : 35 Question Type : MCQ Option Shuffling : Yes
Correct Marks : 4 Wrong Marks : 1

એક ધાતુ (A) ને નાઈટ્રોજન વાયુ સાથે ગરમ કરવા સંયોજન B મળે છે. B ની પાણી સાથે પ્રક્રિયા કરતા રંગવિહીન વાયુ મળે છે તેને $CuSO_4$ નાં દ્રાવણમાંથી પસાર કરતા ગાઢા ભૂરો-જાંબલી રંગનું દ્રાવણ મળે છે. A અને B અનુક્રમે છે :

Options :

1. Na અને Na_3N

2. Mg અને Mg_3N_2

3. Mg અને $Mg(NO_3)_2$

4. Na અને $NaNO_3$

Question Number : 36 Question Type : MCQ Option Shuffling : Yes
Correct Marks : 4 Wrong Marks : 1

White phosphorus on reaction with concentrated NaOH solution in an inert atmosphere of CO_2 gives phosphine and compound (X). (X) on acidification with HCl gives compound (Y). The basicity of compound (Y) is :

Options :

1. 1

2. 2

3. 3

4. 4

Question Number : 36 Question Type : MCQ Option Shuffling : Yes
Correct Marks : 4 Wrong Marks : 1

સફેદ ફાસ્ફોરસ સાન્દ્ર NaOH વલયન કે સાથ CO₂ કે ઁક નલ્ક્રલય વાતાવરણ મેં અભલ્ક્રલયા કરકે ફાસ્ફીન તથા યૌગલક (X) દેતા હેં। (X), HCl કે સાથ અમ્લીકૃત હોકર યૌગલક (Y) દેતા હેં। યૌગલક (Y) કી ક્ષારકતા હેં :

Options :

1. 1

2. 2

3. 3

4. 4

Question Number : 36 Question Type : MCQ Option Shuffling : Yes
Correct Marks : 4 Wrong Marks : 1

સફેદ ફોસ્ફરસની સાન્દ્ર NaOH દ્રાવણસાથે CO₂ ના નલ્ક્રલય વાતાવરણમાં પ્રક્રલયા કરતા ફોસ્ફીન અને સંયોજન (X) મળે છે. (X) નું HCl સાથે ઁસીટીકરણ કરતાં સંયોજન (Y) મળે છે. સંયોજન (Y) ની બેઝલકતા છે :

Options :

1. 1

2. 2

3. 3

4. 4

Question Number : 37 Question Type : MCQ Option Shuffling : Yes
Correct Marks : 4 Wrong Marks : 1

The correct order of the calculated
spin-only magnetic moments of complexes

(A) to (D) is :

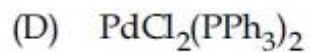
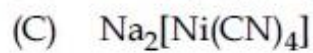
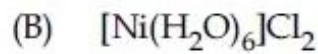
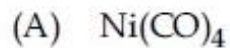

Options :

1. $(\text{C}) < (\text{D}) < (\text{B}) < (\text{A})$

2. $(\text{C}) \approx (\text{D}) < (\text{B}) < (\text{A})$

3. $(\text{A}) \approx (\text{C}) < (\text{B}) \approx (\text{D})$

4. $(\text{A}) \approx (\text{C}) \approx (\text{D}) < (\text{B})$

Question Number : 37 Question Type : MCQ Option Shuffling : Yes
Correct Marks : 4 Wrong Marks : 1

संकुलों (A) - (D) के प्रचक्रण-मात्र चुम्बकीय आघूर्णों का सही क्रम है :

- (A) $\text{Ni}(\text{CO})_4$
- (B) $[\text{Ni}(\text{H}_2\text{O})_6]\text{Cl}_2$
- (C) $\text{Na}_2[\text{Ni}(\text{CN})_4]$
- (D) $\text{PdCl}_2(\text{PPh}_3)_2$

Options :

1. $(\text{C}) < (\text{D}) < (\text{B}) < (\text{A})$
2. $(\text{C}) \approx (\text{D}) < (\text{B}) < (\text{A})$
3. $(\text{A}) \approx (\text{C}) < (\text{B}) \approx (\text{D})$
4. $(\text{A}) \approx (\text{C}) \approx (\text{D}) < (\text{B})$

Question Number : 37 Question Type : MCQ Option Shuffling : Yes
Correct Marks : 4 Wrong Marks : 1

संकुलों (A) - (D) नी गणेशली इक्षत स्पिन चुम्बकीय
थाकभात्रानो साथो क्रम छे :

- (A) $\text{Ni}(\text{CO})_4$
- (B) $[\text{Ni}(\text{H}_2\text{O})_6]\text{Cl}_2$
- (C) $\text{Na}_2[\text{Ni}(\text{CN})_4]$
- (D) $\text{PdCl}_2(\text{PPh}_3)_2$

Options :

1. $(\text{C}) < (\text{D}) < (\text{B}) < (\text{A})$
2. $(\text{C}) \approx (\text{D}) < (\text{B}) < (\text{A})$

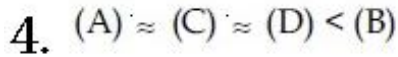
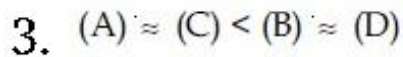

Question Number : 38 Question Type : MCQ Option Shuffling : Yes
Correct Marks : 4 Wrong Marks : 1

Among (a) - (d), the complexes that can display geometrical isomerism are :

- (a) $[\text{Pt}(\text{NH}_3)_3\text{Cl}]^+$
- (b) $[\text{Pt}(\text{NH}_3)\text{Cl}_5]^-$
- (c) $[\text{Pt}(\text{NH}_3)_2\text{Cl}(\text{NO}_2)]$
- (d) $[\text{Pt}(\text{NH}_3)_4\text{ClBr}]^{2+}$

Options :

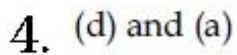
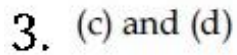
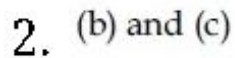
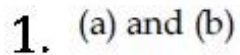

Question Number : 38 Question Type : MCQ Option Shuffling : Yes
Correct Marks : 4 Wrong Marks : 1

(a) - (d) में से, संकुल जो ज्यामितीय समावयवता प्रदर्शित कर सकते हैं, हैं :

- (a) $[\text{Pt}(\text{NH}_3)_3\text{Cl}]^+$
- (b) $[\text{Pt}(\text{NH}_3)\text{Cl}_5]^-$
- (c) $[\text{Pt}(\text{NH}_3)_2\text{Cl}(\text{NO}_2)]$
- (d) $[\text{Pt}(\text{NH}_3)_4\text{ClBr}]^{2+}$

Options :

1. (a) तथा (b)

2. (b) तथा (c)

3. (c) तथा (d)

4. (d) तथा (a)

Question Number : 38 Question Type : MCQ Option Shuffling : Yes
Correct Marks : 4 Wrong Marks : 1

(a) - (d) પૈકી, સંકીર્ણો જે ભૌમિતિક સમઘટક દર્શાવે છે તેઓ :

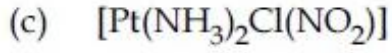
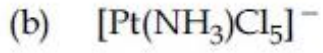
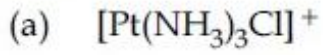

Options :

1. (a) અને (b)

2. (b) અને (c)

3. (c) અને (d)

4. (d) અને (a)

Question Number : 39 Question Type : MCQ Option Shuffling : Yes
Correct Marks : 4 Wrong Marks : 1

Two monomers in maltose are :

Options :

1. α -D-glucose and α -D-Fructose
2. α -D-glucose and α -D-glucose
3. α -D-glucose and α -D-galactose
4. α -D-glucose and β -D-glucose

Question Number : 39 Question Type : MCQ Option Shuffling : Yes

Correct Marks : 4 Wrong Marks : 1

माल्टोस में दो एकलक हैं :

Options :

1. α -D-ग्लूकोस तथा α -D-फ्रुक्टोस
2. α -D-ग्लूकोस तथा α -D-ग्लूकोस
3. α -D-ग्लूकोस तथा α -D-गैलेक्टोस
4. α -D-ग्लूकोस तथा β -D-ग्लूकोस

Question Number : 39 Question Type : MCQ Option Shuffling : Yes

Correct Marks : 4 Wrong Marks : 1

માલ્ટોઝના બે મોનોમર છે :

Options :

1. α -D-ગ્લુકોઝ અને α -D-ફ્રુક્ટોઝ

2. α -D-ગ્લુકોઝ અને α -D-ગ્લુકોઝ

3. α -D-ગ્લુકોઝ અને α -D-ગેલેક્ટોઝ

4. α -D-ગ્લુકોઝ અને β -D-ગ્લુકોઝ

Question Number : 40 Question Type : MCQ Option Shuffling : Yes
Correct Marks : 4 Wrong Marks : 1

Kjeldahl's method cannot be used to estimate nitrogen for which of the following compounds ?

Options :

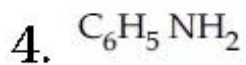
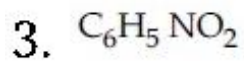
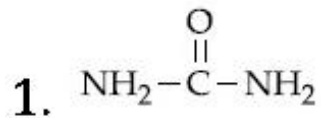

Question Number : 40 Question Type : MCQ Option Shuffling : Yes
Correct Marks : 4 Wrong Marks : 1

निम्नलिखित यौगिकों में से किसके लिए नाइट्रोजन के आकलन के लिए केलडाल विधि का उपयोग नहीं किया जा सकता है ?

Options :

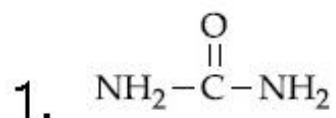

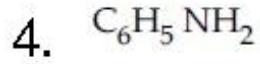
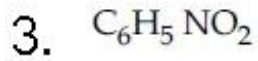
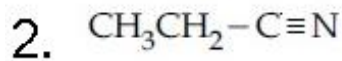

Question Number : 40 Question Type : MCQ Option Shuffling : Yes

Correct Marks : 4 Wrong Marks : 1

જેલ્ડાહલની રીતથી નાઈટ્રોજનના પરિમાપનમાં નીચેના માંથી કયા સંયોજનો વાપરી ન શકાય?

Options :

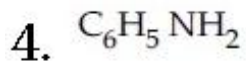
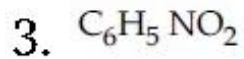
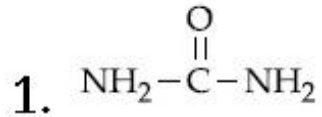

Question Number : 41 Question Type : MCQ Option Shuffling : Yes

Correct Marks : 4 Wrong Marks : 1

The major product in the following reaction is :

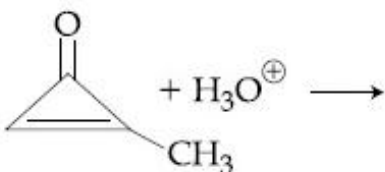

Options :

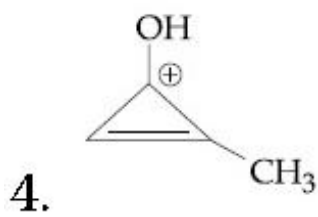
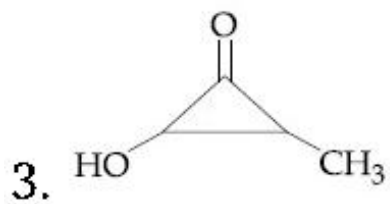
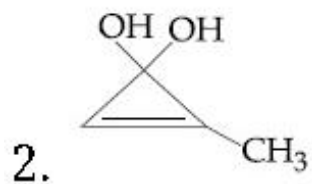
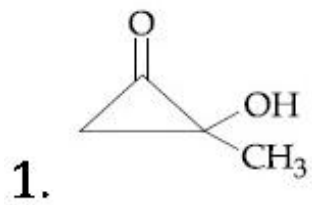

Question Number : 41 Question Type : MCQ Option Shuffling : Yes
 Correct Marks : 4 Wrong Marks : 1

निम्नलिखित अभिक्रिया में मुख्य उत्पाद है :

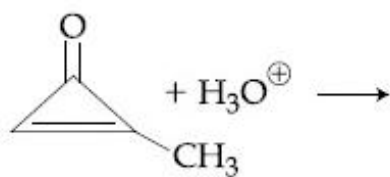

Options :

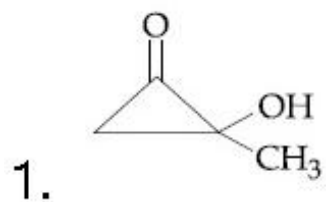

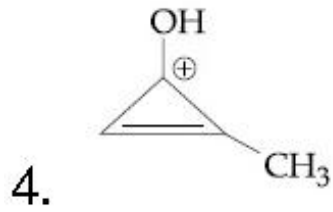
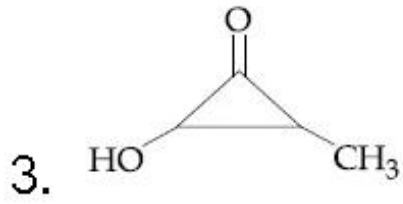
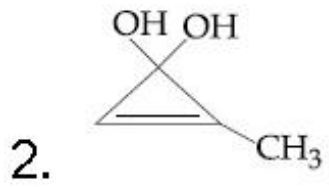

Question Number : 41 Question Type : MCQ Option Shuffling : Yes

Correct Marks : 4 Wrong Marks : 1

નીચેની પ્રક્રિયાની મુખ્ય નીપજ છે :

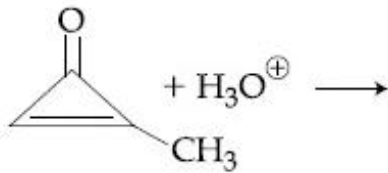

Options :

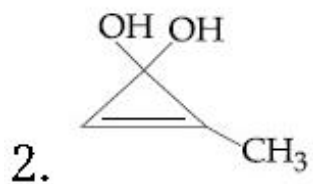
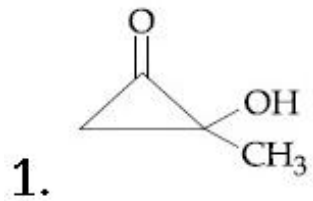

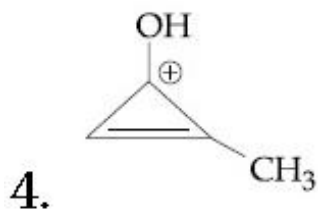
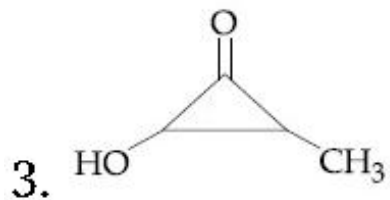

Question Number : 42 Question Type : MCQ Option Shuffling : Yes
Correct Marks : 4 Wrong Marks : 1

An unsaturated hydrocarbon X absorbs two hydrogen molecules on catalytic hydrogenation, and also gives following reaction :

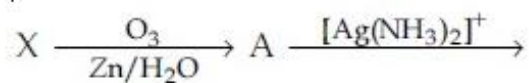

B(3-oxo-hexanedicarboxylic acid)

X will be :

Options :

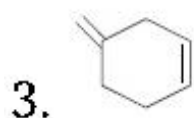
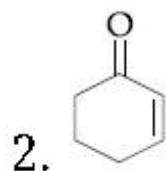
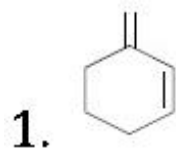

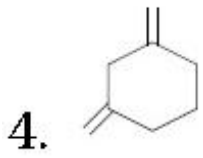

Question Number : 42 Question Type : MCQ Option Shuffling : Yes

Correct Marks : 4 Wrong Marks : 1

एक असंतृप्त हाइड्रोकार्बन X उत्प्रेरित हाइड्रोजनीकरण करने पर हाइड्रोजन के दो अणुओं को अवशोषित करता है तथा निम्नलिखित अभिक्रिया भी देता है :

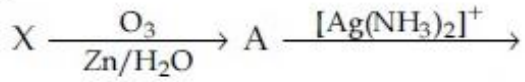

B(3-oxo-hexanedicarboxylic acid)

X होगा :

Options :

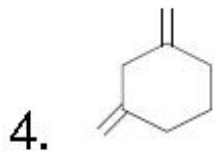
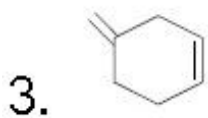
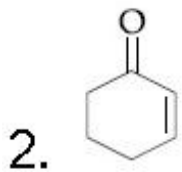
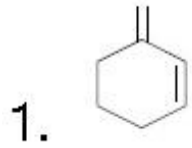

Question Number : 42 Question Type : MCQ Option Shuffling : Yes

Correct Marks : 4 Wrong Marks : 1

કેટાલિટીક હાઇડ્રોજનેશનમાં એક સસંતૃપ્ત હાઇડ્રોકાર્બન X હાઇડ્રોજનના બે આણુઓનું શોષણ કરે છે અને નીચેની પ્રક્રિયાઓ પણ આપે છે :

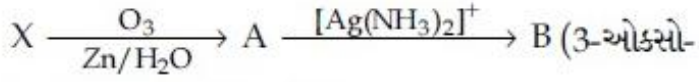

હેક્ઝેનડાયકાર્બોક્સીલીક એસિડ)

X હશે :

Options :

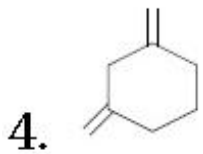
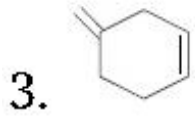
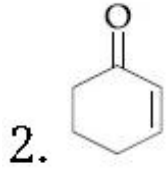
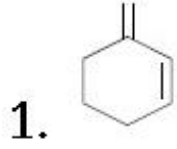

Question Number : 43 Question Type : MCQ Option Shuffling : Yes

Correct Marks : 4 Wrong Marks : 1

Preparation of Bakelite proceeds via reactions :

Options :

Electrophilic substitution and

1. dehydration

2. Electrophilic addition and dehydration

3. Nucleophilic addition and dehydration

4. Condensation and elimination

Question Number : 43 Question Type : MCQ Option Shuffling : Yes
Correct Marks : 4 Wrong Marks : 1

બેકેલાઇટ કા વિરચન નિમ્નલિખિત અભિક્રિયાઓ સે
હોકર અગ્રસરિત હોતા હૈ :

Options :

1. ઇલેક્ટ્રોનસ્નેહી પ્રતિસ્થાપન તથા નિર્જલન

2. ઇલેક્ટ્રોનસ્નેહી યોગજ તથા નિર્જલન

3. નાભિકસ્નેહી યોગજ તથા નિર્જલન

4. સંઘનન ઓર નિરાકરણ

Question Number : 43 Question Type : MCQ Option Shuffling : Yes
Correct Marks : 4 Wrong Marks : 1

બેકેલાઇટની બનાવટ કઈ પ્રક્રિયાથી થાય છે :

Options :

1. ઇલેક્ટ્રોન અનુરાગી વિસ્થાપન અને નિર્જળીકરણ

2. ઇલેક્ટ્રોન અનુરાગી યોગશીલ અને નિર્જળીકરણ

3. કેન્દ્ર અનુરાગી યોગશીલ અને નિર્જળીકરણ

4. સંઘનન અને નિરસન

Question Number : 44 Question Type : MCQ Option Shuffling : Yes
Correct Marks : 4 Wrong Marks : 1

Among the compounds A and B with molecular formula $C_9H_{18}O_3$, A is having higher boiling point than B. The possible structures of A and B are :

Options :

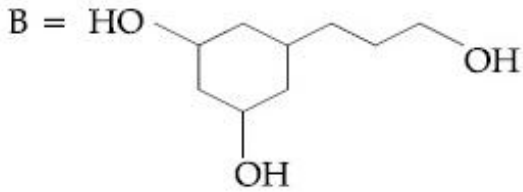
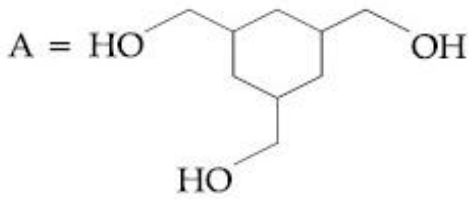

1.

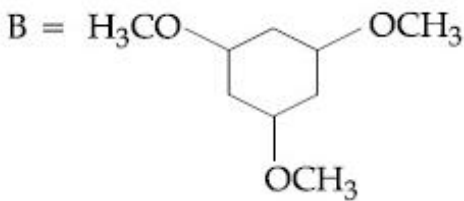
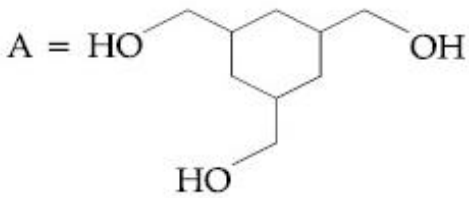

2.

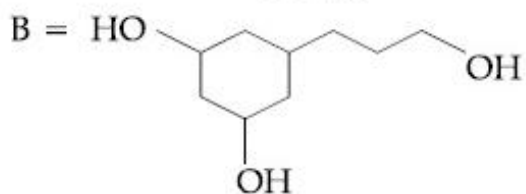
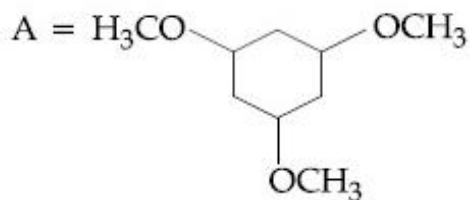

3.

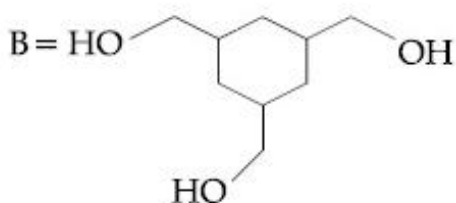
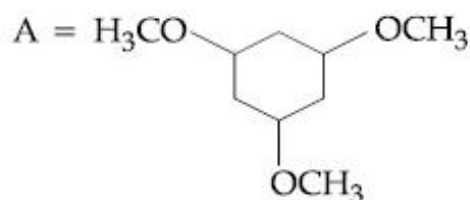

4.

Question Number : 44 Question Type : MCQ Option Shuffling : Yes
Correct Marks : 4 Wrong Marks : 1

यौगिकों A तथा B, जिनका आण्विक सूत्र $C_9H_{18}O_3$ है, में से B की अपेक्षा A का क्वथनांक अधिक है।
A तथा B की संभावित संरचनाएँ हैं :

Options :

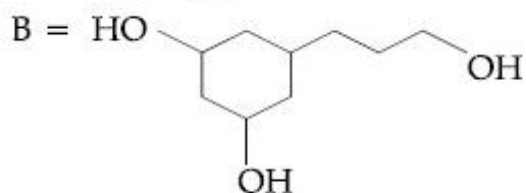
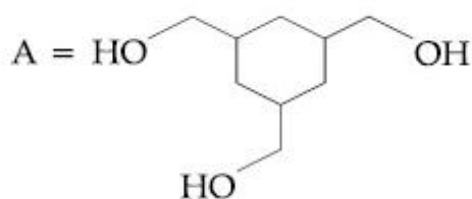

1.

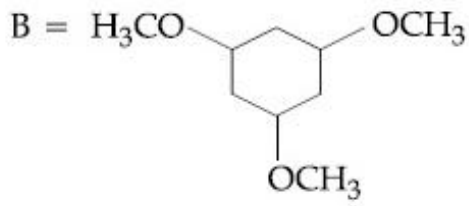
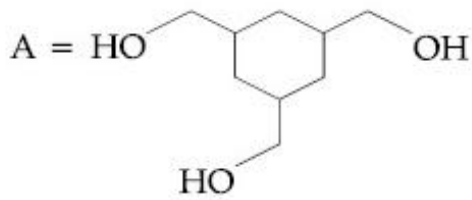

2.

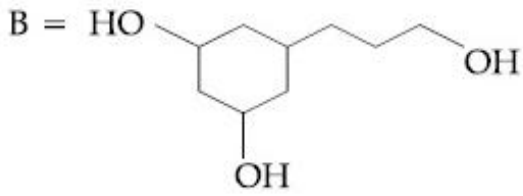
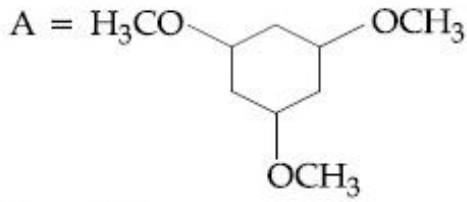

3.

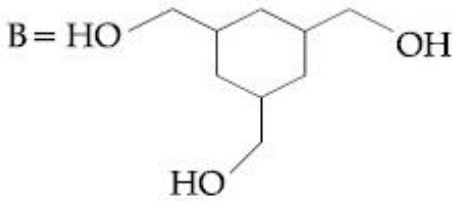
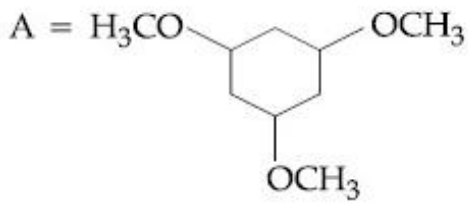

4.

Question Number : 44 Question Type : MCQ Option Shuffling : Yes

Correct Marks : 4 Wrong Marks : 1

$C_9H_{18}O_3$ અણુસૂત્ર ધરાવતા સંયોજનો A અને B પૈકી, A નું ઉત્કલનબિંદુ B કરતા વધુ છે. A અને B ના શક્ય બંધારણો છે :

Options :

1.

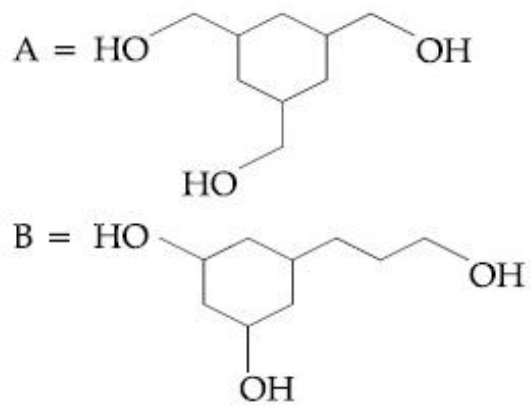

2.

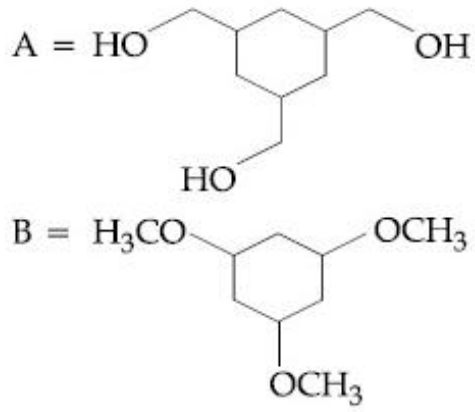

3.

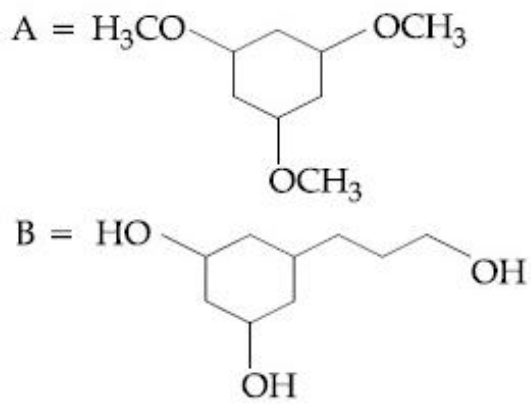

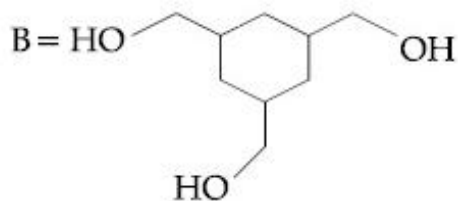
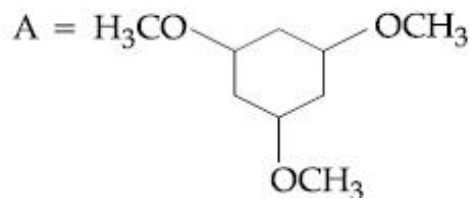

4.

Question Number : 45 Question Type : MCQ Option Shuffling : Yes
Correct Marks : 4 Wrong Marks : 1

The major product [B] in the following sequence of reactions is :

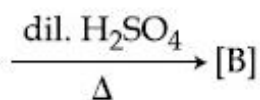
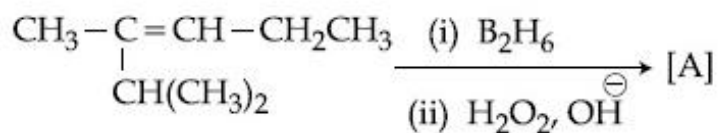

Options :

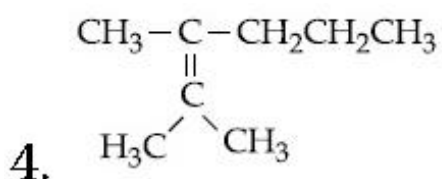
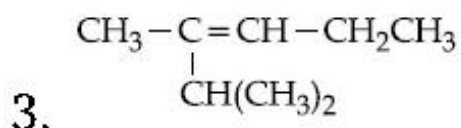
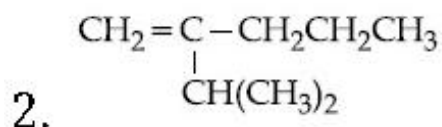
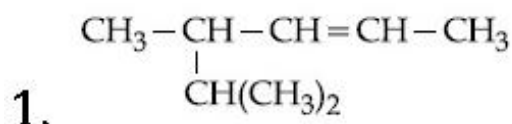

Question Number : 45 Question Type : MCQ Option Shuffling : Yes

Correct Marks : 4 Wrong Marks : 1

निम्नलिखित अभिक्रिया-अनुक्रम में मुख्य उत्पाद [B]

है :

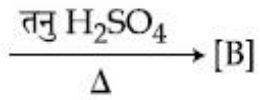
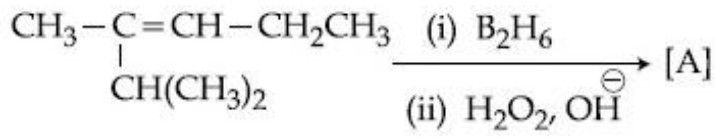

Options :

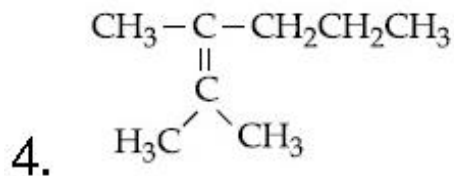
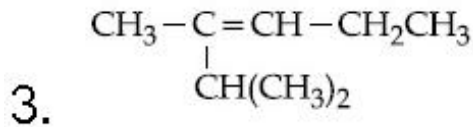
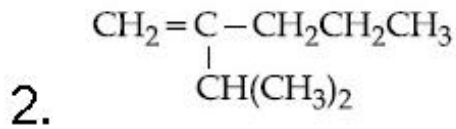
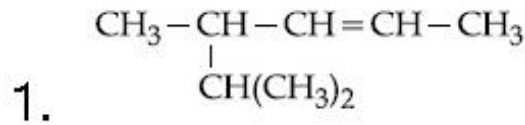

Question Number : 45 Question Type : MCQ Option Shuffling : Yes

Correct Marks : 4 Wrong Marks : 1

आपेली प्रक्रियाओनी श्रेणीमां नी मुख्य नीपण [B]

शोधो :

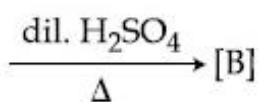
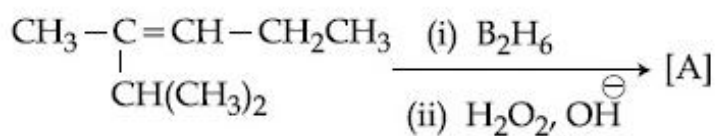

Options :

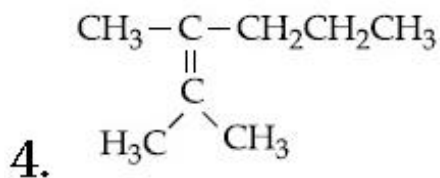
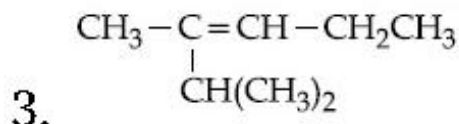
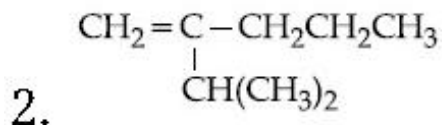
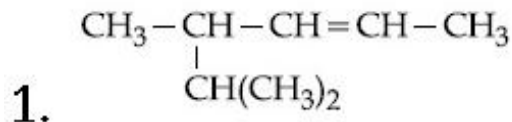

Sub-Section Number:

2

Sub-Section Id:

405036107

Question Shuffling Allowed :

Yes

Question Number : 46 Question Type : SA

Correct Marks : 4 Wrong Marks : 0

NaClO_3 is used, even in spacecrafts, to produce O_2 . The daily consumption of pure O_2 by a person is 492 L at 1 atm, 300 K. How much amount of NaClO_3 , in grams, is required to produce O_2 for the daily consumption of a person at 1 atm, 300 K ?

_____.

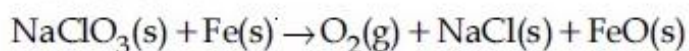

$$R = 0.082 \text{ L atm mol}^{-1} \text{ K}^{-1}$$

Response Type: Numeric

Evaluation Required For SA: Yes

Show Word Count: Yes

Answers Type: Range

Possible Answers :

2120 to 2140

Question Number : 46 Question Type : SA

Correct Marks : 4 Wrong Marks : 0

NaClO_3 का उपयोग O_2 के उत्पादन के लिए, अंतरिक्ष यानों में भी, किया जाता है। एक व्यक्ति द्वारा शुद्ध ऑक्सीजन की प्रतिदिन की खपत 492 L (1 atm, 300 K पर) है। 1 atm, 300 K पर व्यक्ति के प्रतिदिन की खपत के लिए ऑक्सीजन के उत्पादन के लिए आवश्यक NaClO_3 की मात्रा (g में) होगी _____.

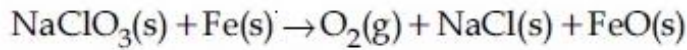

$$R = 0.082 \text{ L atm mol}^{-1} \text{ K}^{-1}$$

Response Type: Numeric

Evaluation Required For SA: Yes

Show Word Count: Yes

Answers Type: Range

Possible Answers :

2120 to 2140

Question Number : 46 Question Type : SA

Correct Marks : 4 Wrong Marks : 0

NaClO_3 નો અવકાશયાનમાં O_2 ઉત્પાદન કરવામાં વપરાય છે. 1 વાતા અને 300 K એ એક વ્યક્તિની શુદ્ધ ઓક્સીજનની દૈનિક ખપત 492 L છે. તે વ્યક્તિની દૈનિક ખપત માટે 1 વાતા અને 300 K એ જરૂરી O_2 માટે NaClO_3 ની માત્રા (g માં) _____.

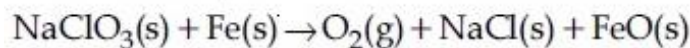

$$R = 0.082 \text{ L atm mol}^{-1} \text{ K}^{-1}$$

Response Type: Numeric

Evaluation Required For SA: Yes

Show Word Count: Yes

Answers Type: Range

Possible Answers :

2120 to 2140

Question Number : 47 Question Type : SA

Correct Marks : 4 Wrong Marks : 0

At constant volume, 4 mol of an ideal gas when heated from 300 K to 500 K changes its internal energy by 5000 J. The molar heat capacity at constant volume is _____.

Response Type: Numeric

Evaluation Required For SA: Yes

Show Word Count: Yes

Answers Type: Range

Possible Answers :

6.25 to 6.25

Question Number : 47 Question Type : SA

Correct Marks : 4 Wrong Marks : 0

स्थिर आयतन पर, एक आदर्श गैस के 4 mol को जब 300 K से 500 K तक गरम किया जाता है तो इसकी आंतरिक ऊर्जा में 5000 J का परिवर्तन होता है। स्थिर आयतन पर मोलर ऊष्मा धारिता है _____।

Response Type: Numeric

Evaluation Required For SA: Yes

Show Word Count: Yes

Answers Type: Range

Possible Answers :

6.25 to 6.25

Question Number : 47 Question Type : SA

Correct Marks : 4 Wrong Marks : 0

અચળ દબાણે, એક આદર્શવાયુના 4 મોલને 300 K થી 500 K ગરમ કરતાં તેની આંતરિક ઉર્જામાં 5000 J નો ફેરફાર થાય છે. અચળ દબાણે મોલર ઉષ્મા ક્ષમતા છે _____.

Response Type: Numeric

Evaluation Required For SA: Yes

Show Word Count: Yes

Answers Type: Range

Possible Answers :

6.25 to 6.25

Question Number : 48 Question Type : SA

Correct Marks : 4 Wrong Marks : 0

For an electrochemical cell



the ratio $\frac{[\text{Sn}^{2+}]}{[\text{Pb}^{2+}]}$ when this cell attains

equilibrium is _____.

$$\left(\text{Given : } E_{\text{Sn}^{2+}|\text{Sn}}^0 = -0.14\text{V}, \right.$$

$$\left. E_{\text{Pb}^{2+}|\text{Pb}}^0 = -0.13\text{V}, \frac{2.303RT}{F} = 0.06 \right)$$

Response Type: Numeric

Evaluation Required For SA: Yes

Show Word Count: Yes

Answers Type: Range

Possible Answers :

2.13 to 2.17

Question Number : 48 Question Type : SA

Correct Marks : 4 Wrong Marks : 0

एक वैद्युतरासायनिक सेल



के लिए, जब सेल साम्यावस्था को प्राप्त करता है, तो

अनुपात $\frac{[\text{Sn}^{2+}]}{[\text{Pb}^{2+}]}$ है _____ ।

(दिया गया है : $E^0_{\text{Sn}^{2+}|\text{Sn}} = -0.14\text{V}$,

$E^0_{\text{Pb}^{2+}|\text{Pb}} = -0.13\text{V}$, $\frac{2.303RT}{F} = 0.06$)

Response Type: Numeric

Evaluation Required For SA: Yes

Show Word Count: Yes

Answers Type: Range

Possible Answers :

2.13 to 2.17

Question Number : 48 **Question Type :** SA

Correct Marks : 4 **Wrong Marks :** 0

એક ઈલેક્ટ્રોરાસાયણિક કોશ માટે,



જ્યારે કોશ સંતુલન અવસ્થા પ્રાપ્ત કરે છે ત્યારે $\frac{[\text{Sn}^{2+}]}{[\text{Pb}^{2+}]}$

નો ગુણોત્તર છે _____.

(આપેલ : $E^0_{\text{Sn}^{2+}|\text{Sn}} = -0.14\text{V}$,

$E^0_{\text{Pb}^{2+}|\text{Pb}} = -0.13\text{V}$, $\frac{2.303RT}{F} = 0.06$)

Response Type: Numeric

Evaluation Required For SA: Yes

Show Word Count: Yes

Answers Type: Range

Possible Answers :

2.13 to 2.17

Question Number : 49 **Question Type :** SA

Correct Marks : 4 **Wrong Marks :** 0

Complexes (ML_5) of metals Ni and Fe have ideal square pyramidal and trigonal bipyramidal geometries, respectively. The sum of the 90° , 120° and 180° L-M-L angles in the two complexes is _____.

Response Type: Numeric

Evaluation Required For SA: Yes

Show Word Count: Yes

Answers Type: Range

Possible Answers :

20 to 20

Question Number : 49 Question Type : SA

Correct Marks : 4 Wrong Marks : 0

Ni तथा Fe धातुओं के संकुलों (ML_5) की ज्यामितियाँ क्रमशः आदर्श वर्ग पिरैमिडी तथा त्रिसमनताक्ष द्विपिरैमिडी हैं। दोनों संकुलों में 90° , 120° तथा 180° L-M-L कोणों का योग है _____।

Response Type: Numeric

Evaluation Required For SA: Yes

Show Word Count: Yes

Answers Type: Range

Possible Answers :

20 to 20

Question Number : 49 Question Type : SA

Correct Marks : 4 Wrong Marks : 0

धातुઓ Ni અને Fe ના સંકીર્ણો (ML_5) અનુક્રમે આદર્શ સમચોરસ પિરામિડ અને ત્રિકોણીય દ્વિપિરામિડ ભૂમિતિઓ ધરાવે છે. બે સંકીર્ણો ના 90° , 120° અને 180° L-M-L ખૂણાઓનો સરવાળો છે _____.

Response Type: Numeric

Evaluation Required For SA: Yes

Show Word Count: Yes

Answers Type: Range

Possible Answers :

20 to 20

Question Number : 50 Question Type : SA

Correct Marks : 4 Wrong Marks : 0

In the following sequence of reactions the maximum number of atoms present in molecule 'C' in one plane is _____.

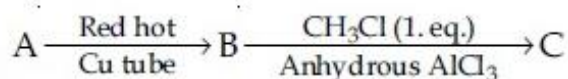

(A is a lowest molecular weight alkyne)

Response Type: Numeric

Evaluation Required For SA: Yes

Show Word Count: Yes

Answers Type: Range

Possible Answers :

13 to 13

Question Number : 50 Question Type : SA

Correct Marks : 4 Wrong Marks : 0

निम्नलिखित अभिक्रिया अनुक्रम में अणु 'C' में एक तल में, उपस्थित परमाणुओं की अधिकतम संख्या है

_____।

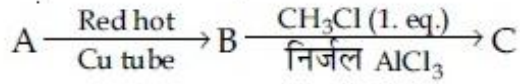

(A एक अल्पतम अणुभार की एल्काइन है)

Response Type: Numeric

Evaluation Required For SA: Yes

Show Word Count: Yes

Answers Type: Range

Possible Answers :

13 to 13

Question Number : 50 Question Type : SA

Correct Marks : 4 Wrong Marks : 0

आपेली प्रक्रिया श्रेणीमां, आणु 'C' मां अेक व तलमां
हाजर परमाणुओनी महत्तम संख्या छे _____.

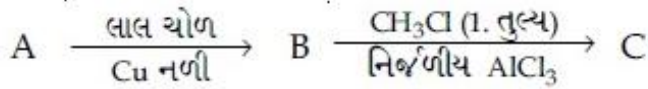

(A अेक न्युनतम आणुभार धरावतो आल्काईन)

Response Type: Numeric

Evaluation Required For SA: Yes

Show Word Count: Yes

Answers Type: Range

Possible Answers :

13 to 13

Mathematics

Section Id :	40503668
Section Number :	3
Section type :	Online
Mandatory or Optional:	Mandatory
Number of Questions:	25
Number of Questions to be attempted:	25
Section Marks:	100

Sub-Section Number:	1
Sub-Section Id:	405036108
Question Shuffling Allowed :	Yes

Question Number : 51 Question Type : MCQ Option Shuffling : Yes

Correct Marks : 4 Wrong Marks : 1

Let $f: (1, 3) \rightarrow \mathbb{R}$ be a function defined by

$$f(x) = \frac{x[x]}{1+x^2}, \text{ where } [x] \text{ denotes the}$$

greatest integer $\leq x$. Then the range of f is :

Options :

1. $\left(\frac{3}{5}, \frac{4}{5}\right)$

2. $\left(\frac{2}{5}, \frac{4}{5}\right]$

3. $\left(\frac{2}{5}, \frac{1}{2}\right) \cup \left(\frac{3}{5}, \frac{4}{5}\right]$

4. $\left(\frac{2}{5}, \frac{3}{5}\right] \cup \left(\frac{3}{4}, \frac{4}{5}\right]$

Question Number : 51 Question Type : MCQ Option Shuffling : Yes

Correct Marks : 4 Wrong Marks : 1

माना $f: (1, 3) \rightarrow \mathbb{R}$ एक फलन है, जो

$$f(x) = \frac{x[x]}{1+x^2}, \text{ द्वारा परिभाषित है जहाँ } [x] \text{ महत्तम}$$

पूर्णांक $\leq x$ को दर्शाता है। तो f का परिसर है :

Options :

1. $\left(\frac{3}{5}, \frac{4}{5}\right)$

2. $\left(\frac{2}{5}, \frac{4}{5}\right]$

3. $\left(\frac{2}{5}, \frac{1}{2}\right) \cup \left(\frac{3}{5}, \frac{4}{5}\right]$

4. $\left(\frac{2}{5}, \frac{3}{5}\right] \cup \left(\frac{3}{4}, \frac{4}{5}\right)$

Question Number : 51 Question Type : MCQ Option Shuffling : Yes
Correct Marks : 4 Wrong Marks : 1

ધારો કે $f : (1, 3) \rightarrow \mathbb{R}$, $f(x) = \frac{x[x]}{1+x^2}$ થી

વ્યાખ્યાયિત વિધેય છે, જ્યાં $[x]$ એ મોટામાં મોટો પૂર્ણાંક $\leq x$ છે. તો વિધેય f નો વિસ્તાર નીચ્ચેનામાંથી કયો થશે?

Options :

1. $\left(\frac{3}{5}, \frac{4}{5}\right)$

2. $\left(\frac{2}{5}, \frac{4}{5}\right]$

3. $\left(\frac{2}{5}, \frac{1}{2}\right) \cup \left(\frac{3}{5}, \frac{4}{5}\right]$

4. $\left(\frac{2}{5}, \frac{3}{5}\right] \cup \left(\frac{3}{4}, \frac{4}{5}\right)$

Question Number : 52 Question Type : MCQ Option Shuffling : Yes
Correct Marks : 4 Wrong Marks : 1

Let $\alpha = \frac{-1 + i\sqrt{3}}{2}$. If

$a = (1 + \alpha) \sum_{k=0}^{100} \alpha^{2k}$ and $b = \sum_{k=0}^{100} \alpha^{3k}$, then

a and b are the roots of the quadratic equation :

Options :

1. $x^2 + 101x + 100 = 0$

2. $x^2 + 102x + 101 = 0$

3. $x^2 - 101x + 100 = 0$

4. $x^2 - 102x + 101 = 0$

Question Number : 52 Question Type : MCQ Option Shuffling : Yes

Correct Marks : 4 Wrong Marks : 1

माना $\alpha = \frac{-1 + i\sqrt{3}}{2}$ है। यदि

$a = (1 + \alpha) \sum_{k=0}^{100} \alpha^{2k}$ तथा $b = \sum_{k=0}^{100} \alpha^{3k}$, तो

a तथा b निम्न में से किस द्विघात समीकरण के मूल हैं?

Options :

1. $x^2 + 101x + 100 = 0$

2. $x^2 + 102x + 101 = 0$

3. $x^2 - 101x + 100 = 0$

4. $x^2 - 102x + 101 = 0$

Question Number : 52 Question Type : MCQ Option Shuffling : Yes

Correct Marks : 4 Wrong Marks : 1

ધરો કે $\alpha = \frac{-1 + i\sqrt{3}}{2}$ છે. જો

$a = (1 + \alpha) \sum_{k=0}^{100} \alpha^{2k}$ અને $b = \sum_{k=0}^{100} \alpha^{3k}$ હોય,

તો a અને b નીચેનામાંથી કયા દ્વિઘાત સમીકરણનાં બીજ થાય?

Options :

1. $x^2 + 101x + 100 = 0$

2. $x^2 + 102x + 101 = 0$

3. $x^2 - 101x + 100 = 0$

4. $x^2 - 102x + 101 = 0$

Question Number : 53 Question Type : MCQ Option Shuffling : Yes

Correct Marks : 4 Wrong Marks : 1

Let S be the set of all real roots of the equation, $3^x(3^x - 1) + 2 = |3^x - 1| + |3^x - 2|$.

Then S :

Options :

1. is an empty set.

2. is a singleton.

3. contains exactly two elements.

4. contains at least four elements.

Question Number : 53 Question Type : MCQ Option Shuffling : Yes

Correct Marks : 4 Wrong Marks : 1

माना समीकरण $3^x(3^x - 1) + 2 = |3^x - 1| + |3^x - 2|$

के सभी वास्तविक मूलों का समुच्चय S है। तो S :

Options :

1. एक रिक्त समुच्चय है।

2. एक ही अवयव वाला समुच्चय है।

3. में मात्र दो अवयव हैं।

4. में कम से कम चार अवयव हैं।

Question Number : 53 Question Type : MCQ Option Shuffling : Yes

Correct Marks : 4 Wrong Marks : 1

धरो के S के समीकरण

$3^x(3^x - 1) + 2 = |3^x - 1| + |3^x - 2|$ नां तमाम

वास्तविक मूलो नो गइ छे. तो S के :

Options :

1. ખાલી ગણ છે.

2. એકાકી ગણ છે.

3. બરાબર બે ઘટકો ધરાવે છે.

4. ઓછામાં ઓછા ચાર ઘટકો ધરાવે છે.

Question Number : 54 Question Type : MCQ Option Shuffling : Yes
Correct Marks : 4 Wrong Marks : 1

If $A = \begin{pmatrix} 2 & 2 \\ 9 & 4 \end{pmatrix}$ and $I = \begin{pmatrix} 1 & 0 \\ 0 & 1 \end{pmatrix}$, then

$10A^{-1}$ is equal to :

Options :

1. $6I - A$

2. $4I - A$

3. $A - 4I$

4. $A - 6I$

Question Number : 54 Question Type : MCQ Option Shuffling : Yes
Correct Marks : 4 Wrong Marks : 1

यदि $A = \begin{pmatrix} 2 & 2 \\ 9 & 4 \end{pmatrix}$ तथा $I = \begin{pmatrix} 1 & 0 \\ 0 & 1 \end{pmatrix}$ हैं, तो

$10A^{-1}$ बराबर है :

Options :

1. $6I - A$

2. $4I - A$

3. $A - 4I$

4. $A - 6I$

Question Number : 54 Question Type : MCQ Option Shuffling : Yes
Correct Marks : 4 Wrong Marks : 1

જો $A = \begin{pmatrix} 2 & 2 \\ 9 & 4 \end{pmatrix}$ અને $I = \begin{pmatrix} 1 & 0 \\ 0 & 1 \end{pmatrix}$ હોય તો

$10A^{-1} =$

Options :

1. $6I - A$

2. $4I - A$

3. $A - 4I$

4. $A - 6I$

Question Number : 55 Question Type : MCQ Option Shuffling : Yes
Correct Marks : 4 Wrong Marks : 1

The system of linear equations

$$\lambda x + 2y + 2z = 5$$

$$2\lambda x + 3y + 5z = 8$$

$$4x + \lambda y + 6z = 10 \text{ has :}$$

Options :

1. a unique solution when $\lambda = -8$

2. no solution when $\lambda = 8$

3. infinitely many solutions when $\lambda = 2$

4. no solution when $\lambda = 2$

Question Number : 55 Question Type : MCQ Option Shuffling : Yes

Correct Marks : 4 Wrong Marks : 1

રૈખિક સમીકરણ નિકાય

$$\lambda x + 2y + 2z = 5$$

$$2\lambda x + 3y + 5z = 8$$

$$4x + \lambda y + 6z = 10$$

Options :

1. કા માત્ર ઁક હલ હૈ જબ $\lambda = -8$

2. કા કોઈ હલ નહીં હૈ જબ $\lambda = 8$

3. કે અનન્ત હલ હૈ જબ $\lambda = 2$

4. કા કોઈ હલ નહીં હૈ જબ $\lambda = 2$

Question Number : 55 Question Type : MCQ Option Shuffling : Yes

Correct Marks : 4 Wrong Marks : 1

સુરેખ સમીકરણ સંહતિ

$$\lambda x + 2y + 2z = 5$$

$$2\lambda x + 3y + 5z = 8$$

$$4x + \lambda y + 6z = 10$$
 ને

Options :

1. $\lambda = -8$ માટે અનન્ય ઉકલ છે.

2. $\lambda = 8$ માટે કોઈ ઉકેલ નથી.

3. $\lambda = 2$ માટે અનંત ઉકેલો છે.

4. $\lambda = 2$ માટે કોઈ ઉકેલ નથી.

Question Number : 56 Question Type : MCQ Option Shuffling : Yes
Correct Marks : 4 Wrong Marks : 1

If α and β be the coefficients of x^4 and x^2 respectively in the expansion of

$\left(x + \sqrt{x^2 - 1}\right)^6 + \left(x - \sqrt{x^2 - 1}\right)^6$, then :

Options :

1. $\alpha + \beta = 60$

2. $\alpha - \beta = -132$

3. $\alpha + \beta = -30$

4. $\alpha - \beta = 60$

Question Number : 56 Question Type : MCQ Option Shuffling : Yes
Correct Marks : 4 Wrong Marks : 1

यदि $\left(x + \sqrt{x^2 - 1}\right)^6 + \left(x - \sqrt{x^2 - 1}\right)^6$ के प्रसार में x^4 तथा x^2 के गुणांक क्रमशः α तथा β हैं, तो :

Options :

1. $\alpha + \beta = 60$

2. $\alpha - \beta = -132$

3. $\alpha + \beta = -30$

4. $\alpha - \beta = 60$

Question Number : 56 Question Type : MCQ Option Shuffling : Yes

Correct Marks : 4 Wrong Marks : 1

જો $(x + \sqrt{x^2 - 1})^6 + (x - \sqrt{x^2 - 1})^6$ ની

વિસ્તરણમાં x^4 અને x^2 ની સહગુણકો અનુક્રમે α અને β હોય, તો :

Options :

1. $\alpha + \beta = 60$

2. $\alpha - \beta = -132$

3. $\alpha + \beta = -30$

4. $\alpha - \beta = 60$

Question Number : 57 Question Type : MCQ Option Shuffling : Yes

Correct Marks : 4 Wrong Marks : 1

If the 10th term of an A.P. is $\frac{1}{20}$ and its

20th term is $\frac{1}{10}$, then the sum of its first

200 terms is :

Options :

1. 50

2. $50\frac{1}{4}$

3. 100

4. $100\frac{1}{2}$

Question Number : 57 Question Type : MCQ Option Shuffling : Yes

Correct Marks : 4 Wrong Marks : 1

यदि एक समान्तर श्रेणी का 10 वां पद $\frac{1}{20}$ है तथा

इसका 20 वां पद $\frac{1}{10}$ है, तो इसके प्रथम 200 पदों का

योग है :

Options :

1. 50

2. $50\frac{1}{4}$

3. 100

4. $100\frac{1}{2}$

Question Number : 57 Question Type : MCQ Option Shuffling : Yes

Correct Marks : 4 Wrong Marks : 1

એક સમાંતર શ્રેણી (A.P.) નું 10 મું પદ $\frac{1}{20}$ હોય અને

તેનું 20 મું પદ $\frac{1}{10}$ હોય તો તેનાં પ્રથમ 200 પદો નો

સરવાળો કેટલો થાય?

Options :

1. 50

2. $50\frac{1}{4}$

3. 100

4. $100\frac{1}{2}$

Question Number : 58 Question Type : MCQ Option Shuffling : Yes

Correct Marks : 4 Wrong Marks : 1

$\lim_{x \rightarrow 0} \frac{\int_0^x t \sin(10t) dt}{x}$ is equal to :

Options :

1. $-\frac{1}{5}$

2. $\frac{1}{10}$

3. $-\frac{1}{10}$

4. 0

Question Number : 58 Question Type : MCQ Option Shuffling : Yes

Correct Marks : 4 Wrong Marks : 1

$$\lim_{x \rightarrow 0} \frac{\int_0^x t \sin(10t) dt}{x} \text{ बराबर है :}$$

Options :

1. $-\frac{1}{5}$

2. $\frac{1}{10}$

3. $-\frac{1}{10}$

4. 0

Question Number : 58 Question Type : MCQ Option Shuffling : Yes

Correct Marks : 4 Wrong Marks : 1

$$\lim_{x \rightarrow 0} \frac{\int_0^x t \sin(10t) dt}{x} \text{ बराबर है :}$$

Options :

1. $-\frac{1}{5}$

2. $\frac{1}{10}$

3. $-\frac{1}{10}$

4. 0

Question Number : 59 Question Type : MCQ Option Shuffling : Yes

Correct Marks : 4 Wrong Marks : 1

Let S be the set of all functions $f: [0, 1] \rightarrow \mathbb{R}$, which are continuous on $[0, 1]$ and differentiable on $(0, 1)$. Then for every f in S , there exists a $c \in (0, 1)$, depending on f , such that :

Options :

1. $|f(c) - f(1)| < |f'(c)|$

2. $|f(c) - f(1)| < (1 - c) |f'(c)|$

3. $|f(c) + f(1)| < (1 + c) |f'(c)|$

4. $\frac{f(1) - f(c)}{1 - c} = f'(c)$

Question Number : 59 Question Type : MCQ Option Shuffling : Yes

Correct Marks : 4 Wrong Marks : 1

माना सभी फलनों $f: [0, 1] \rightarrow \mathbb{R}$, जो कि $[0, 1]$ पर संतत हैं तथा $(0, 1)$ पर अवकलनीय हैं, का समुच्चय S है। तो S में प्रत्येक f के लिए f पर निर्भर एक $c \in (0, 1)$ का अस्तित्व इस प्रकार है कि :

Options :

1. $|f(c) - f(1)| < |f'(c)|$

2. $|f(c) - f(1)| < (1 - c) |f'(c)|$

3. $|f(c) + f(1)| < (1+c) |f'(c)|$

4. $\frac{f(1) - f(c)}{1 - c} = f'(c)$

Question Number : 59 Question Type : MCQ Option Shuffling : Yes
Correct Marks : 4 Wrong Marks : 1

ધારો કે S એ એવા તમામ વિધેયો $f: [0, 1] \rightarrow \mathbb{R}$ નો ગણ છે કે જે $[0, 1]$ પર સતત અને $(0, 1)$ પર વિકલનીય છે. તો S માંના પ્રત્યેક f માટે f ઉપર આધારીત એવા એક $c \in (0, 1)$ નું અસ્તીત્વ છે કે જેથી :

Options :

1. $|f(c) - f(1)| < |f'(c)|$

2. $|f(c) - f(1)| < (1-c) |f'(c)|$

3. $|f(c) + f(1)| < (1+c) |f'(c)|$

4. $\frac{f(1) - f(c)}{1 - c} = f'(c)$

Question Number : 60 Question Type : MCQ Option Shuffling : Yes
Correct Marks : 4 Wrong Marks : 1

The length of the perpendicular from the origin, on the normal to the curve, $x^2 + 2xy - 3y^2 = 0$ at the point $(2, 2)$ is :

Options :

1. $\sqrt{2}$

2. 2

3. $2\sqrt{2}$

4. $4\sqrt{2}$

Question Number : 60 Question Type : MCQ Option Shuffling : Yes

Correct Marks : 4 Wrong Marks : 1

वक्र $x^2 + 2xy - 3y^2 = 0$ के बिन्दु $(2, 2)$ पर खींचे गये अभिलम्ब पर मूल बिन्दु से डाले गये लम्ब की लम्बाई है :

Options :

1. $\sqrt{2}$

2. 2

3. $2\sqrt{2}$

4. $4\sqrt{2}$

Question Number : 60 Question Type : MCQ Option Shuffling : Yes

Correct Marks : 4 Wrong Marks : 1

वक्र $x^2 + 2xy - 3y^2 = 0$ का बिन्दु $(2, 2)$ आगणना अभिलम्ब उपर उगमबिन्दुमांथी दरेल लम्ब नी लम्बाई केटली थाय?

Options :

1. $\sqrt{2}$

2. 2

3. $2\sqrt{2}$

4. $4\sqrt{2}$

Question Number : 61 Question Type : MCQ Option Shuffling : Yes
Correct Marks : 4 Wrong Marks : 1

If $I = \int_1^2 \frac{dx}{\sqrt{2x^3 - 9x^2 + 12x + 4}}$, then :

Options :

1. $\frac{1}{9} < I^2 < \frac{1}{8}$

2. $\frac{1}{16} < I^2 < \frac{1}{9}$

3. $\frac{1}{8} < I^2 < \frac{1}{4}$

4. $\frac{1}{6} < I^2 < \frac{1}{2}$

Question Number : 61 Question Type : MCQ Option Shuffling : Yes
Correct Marks : 4 Wrong Marks : 1

यदि $I = \int_1^2 \frac{dx}{\sqrt{2x^3 - 9x^2 + 12x + 4}}$ है, तो :

Options :

1. $\frac{1}{9} < I^2 < \frac{1}{8}$

2. $\frac{1}{16} < I^2 < \frac{1}{9}$

3. $\frac{1}{8} < I^2 < \frac{1}{4}$

4. $\frac{1}{6} < I^2 < \frac{1}{2}$

Question Number : 61 Question Type : MCQ Option Shuffling : Yes
Correct Marks : 4 Wrong Marks : 1

જો $I = \int_1^2 \frac{dx}{\sqrt{2x^3 - 9x^2 + 12x + 4}}$ હોય તો :

Options :

1. $\frac{1}{9} < I^2 < \frac{1}{8}$

2. $\frac{1}{16} < I^2 < \frac{1}{9}$

3. $\frac{1}{8} < I^2 < \frac{1}{4}$

4. $\frac{1}{6} < I^2 < \frac{1}{2}$

Question Number : 62 Question Type : MCQ Option Shuffling : Yes
Correct Marks : 4 Wrong Marks : 1

The area (in sq. units) of the region
 $\{(x, y) \in \mathbb{R}^2 : x^2 \leq y \leq 3 - 2x\}$, is :

Options :

1. $\frac{32}{3}$

2. $\frac{29}{3}$

3. $\frac{31}{3}$

4. $\frac{34}{3}$

Question Number : 62 Question Type : MCQ Option Shuffling : Yes
Correct Marks : 4 Wrong Marks : 1

क्षेत्र $\{(x, y) \in \mathbb{R}^2 : x^2 \leq y \leq 3 - 2x\}$ का क्षेत्रफल
(वर्ग इकाईयों में) है :

Options :

1. $\frac{32}{3}$

2. $\frac{29}{3}$

3. $\frac{31}{3}$

4. $\frac{34}{3}$

Question Number : 62 Question Type : MCQ Option Shuffling : Yes
Correct Marks : 4 Wrong Marks : 1

प्रदेश $\{(x, y) \in \mathbb{R}^2 : x^2 \leq y \leq 3 - 2x\}$ का क्षेत्रफल
(चौ. अंकभूमि) कितना है?

Options :

1. $\frac{32}{3}$

2. $\frac{29}{3}$

3. $\frac{31}{3}$

4. $\frac{34}{3}$

Question Number : 63 Question Type : MCQ Option Shuffling : Yes

Correct Marks : 4 Wrong Marks : 1

The differential equation of the family of curves, $x^2 = 4b(y + b)$, $b \in \mathbb{R}$, is :

Options :

1. $xy'' = y'$

2. $x(y')^2 = x - 2yy'$

3. $x(y')^2 = x + 2yy'$

4. $x(y')^2 = 2yy' - x$

Question Number : 63 Question Type : MCQ Option Shuffling : Yes

Correct Marks : 4 Wrong Marks : 1

वक्रों $x^2 = 4b(y + b)$, $b \in \mathbb{R}$ के कुल का अवकल समीकरण है :

Options :

1. $xy'' = y'$

2. $x(y')^2 = x - 2yy'$

3. $x(y')^2 = x + 2yy'$

4. $x(y')^2 = 2yy' - x$

Question Number : 63 Question Type : MCQ Option Shuffling : Yes

Correct Marks : 4 Wrong Marks : 1

वक्र संलति $x^2 = 4b(y + b)$, $b \in \mathbb{R}$ नुं विकल समीकरण
नीचेनांमांथी कुं थाय?

Options :

1. $xy'' = y'$

2. $x(y')^2 = x - 2yy'$

3. $x(y')^2 = x + 2yy'$

4. $x(y')^2 = 2yy' - x$

Question Number : 64 Question Type : MCQ Option Shuffling : Yes

Correct Marks : 4 Wrong Marks : 1

If a line, $y = mx + c$ is a tangent to the circle,
 $(x - 3)^2 + y^2 = 1$ and it is perpendicular to a
line L_1 , where L_1 is the tangent to the circle,

$x^2 + y^2 = 1$ at the point $\left(\frac{1}{\sqrt{2}}, \frac{1}{\sqrt{2}}\right)$; then :

Options :

1. $c^2 - 7c + 6 = 0$

2. $c^2 + 7c + 6 = 0$

3. $c^2 + 6c + 7 = 0$

4. $c^2 - 6c + 7 = 0$

Question Number : 64 Question Type : MCQ Option Shuffling : Yes

Correct Marks : 4 Wrong Marks : 1

यदि एक रेखा $y = mx + c$, वृत्त $(x - 3)^2 + y^2 = 1$ की एक स्पर्श रेखा है तथा यह एक रेखा L_1 पर लम्ब

है, जहाँ L_1 वृत्त $x^2 + y^2 = 1$ के बिन्दु $\left(\frac{1}{\sqrt{2}}, \frac{1}{\sqrt{2}}\right)$

पर स्पर्श रेखा है, तो :

Options :

1. $c^2 - 7c + 6 = 0$

2. $c^2 + 7c + 6 = 0$

3. $c^2 + 6c + 7 = 0$

4. $c^2 - 6c + 7 = 0$

Question Number : 64 Question Type : MCQ Option Shuffling : Yes

Correct Marks : 4 Wrong Marks : 1

ધારો કે L_1 એ વર્તુળ $x^2 + y^2 = 1$ ને બિંદુ $\left(\frac{1}{\sqrt{2}}, \frac{1}{\sqrt{2}}\right)$

આગળનો સ્પર્શક છે. જો રેખા $y = mx + c$ એ વર્તુળ $(x-3)^2 + y^2 = 1$ નો સ્પર્શક હોય અને રેખા L_1 ને લંબ હોય તો :

Options :

1. $c^2 - 7c + 6 = 0$

2. $c^2 + 7c + 6 = 0$

3. $c^2 + 6c + 7 = 0$

4. $c^2 - 6c + 7 = 0$

Question Number : 65 Question Type : MCQ Option Shuffling : Yes

Correct Marks : 4 Wrong Marks : 1

If a hyperbola passes through the point $P(10, 16)$ and it has vertices at $(\pm 6, 0)$, then the equation of the normal to it at P is :

Options :

1. $3x + 4y = 94$

2. $x + 3y = 58$

3. $x + 2y = 42$

4. $2x + 5y = 100$

Question Number : 65 Question Type : MCQ Option Shuffling : Yes

Correct Marks : 4 Wrong Marks : 1

यदि एक अतिपरवलय बिन्दु $P(10, 16)$ से होकर जाता है तथा इसके शीर्ष $(\pm 6, 0)$ पर हैं, तो P पर इसके अभिलम्ब का समीकरण है :

Options :

1. $3x + 4y = 94$

2. $x + 3y = 58$

3. $x + 2y = 42$

4. $2x + 5y = 100$

Question Number : 65 Question Type : MCQ Option Shuffling : Yes
Correct Marks : 4 Wrong Marks : 1

જો અતિવલય બિંદુ $P(10, 16)$ માંથી પસાર થતો હોય અને તેનાં શિરોબિંદુઓ $(\pm 6, 0)$ આગળ હોય, તો તેને બિંદુ P આગળના અભિલંબનું સમીકરણ નીચેનામાંથી કયું થશે?

Options :

1. $3x + 4y = 94$

2. $x + 3y = 58$

3. $x + 2y = 42$

4. $2x + 5y = 100$

Question Number : 66 Question Type : MCQ Option Shuffling : Yes

Correct Marks : 4 Wrong Marks : 1

The mirror image of the point $(1, 2, 3)$ in a

plane is $\left(-\frac{7}{3}, -\frac{4}{3}, -\frac{1}{3}\right)$. Which of the

following points lies on this plane ?

Options :

1. $(-1, -1, -1)$

2. $(1, 1, 1)$

3. $(1, -1, 1)$

4. $(-1, -1, 1)$

Question Number : 66 Question Type : MCQ Option Shuffling : Yes

Correct Marks : 4 Wrong Marks : 1

बिन्दु $(1, 2, 3)$ का एक समतल में प्रतिबिम्ब (mirror

image), $\left(-\frac{7}{3}, -\frac{4}{3}, -\frac{1}{3}\right)$ है। निम्न में से कौन

सा बिन्दु इस समतल पर स्थित है ?

Options :

1. $(-1, -1, -1)$

2. $(1, 1, 1)$

3. $(1, -1, 1)$

4. $(-1, -1, 1)$

Question Number : 66 Question Type : MCQ Option Shuffling : Yes

Correct Marks : 4 Wrong Marks : 1

બિંદુ $(1, 2, 3)$ નું એક સમતલમાં આરસી પ્રતિબિંબ

$\left(-\frac{7}{3}, -\frac{4}{3}, -\frac{1}{3}\right)$ છે. નીચેનામાંથી કયું બિંદુ આ સમતલમાં હશે?

Options :

1. $(-1, -1, -1)$

2. $(1, 1, 1)$

3. $(1, -1, 1)$

4. $(-1, -1, 1)$

Question Number : 67 Question Type : MCQ Option Shuffling : Yes

Correct Marks : 4 Wrong Marks : 1

Let $\vec{a} = \hat{i} - 2\hat{j} + \hat{k}$ and

$\vec{b} = \hat{i} - \hat{j} + \hat{k}$ be two vectors. If \vec{c} is a

vector such that $\vec{b} \times \vec{c} = \vec{b} \times \vec{a}$ and

$\vec{c} \cdot \vec{a} = 0$, then $\vec{c} \cdot \vec{b}$ is equal to :

Options :

1. $\frac{1}{2}$

2. $-\frac{1}{2}$

3. -1

4. $-\frac{3}{2}$

Question Number : 67 Question Type : MCQ Option Shuffling : Yes
Correct Marks : 4 Wrong Marks : 1

माना दो सदिश $\vec{a} = \hat{i} - 2\hat{j} + \hat{k}$ तथा

$\vec{b} = \hat{i} - \hat{j} + \hat{k}$ हैं। यदि एक सदिश \vec{c} इस

प्रकार है कि $\vec{b} \times \vec{c} = \vec{b} \times \vec{a}$ तथा

$\vec{c} \cdot \vec{a} = 0$ हैं, तो $\vec{c} \cdot \vec{b}$ बराबर है :

Options :

1. $\frac{1}{2}$

2. $-\frac{1}{2}$

3. -1

4. $-\frac{3}{2}$

Question Number : 67 Question Type : MCQ Option Shuffling : Yes
Correct Marks : 4 Wrong Marks : 1

धारी के $\vec{a} = \hat{i} - 2\hat{j} + \hat{k}$ अने

$\vec{b} = \hat{i} - \hat{j} + \hat{k}$ के सदिशो छे. जे \vec{c} अे अेयो

सदिश होय के जेथी $\vec{b} \times \vec{c} = \vec{b} \times \vec{a}$ अने

$\vec{c} \cdot \vec{a} = 0$ थाय, तो $\vec{c} \cdot \vec{b} =$

Options :

1. $\frac{1}{2}$

2. $-\frac{1}{2}$

3. -1

4. $-\frac{3}{2}$

Question Number : 68 Question Type : MCQ Option Shuffling : Yes

Correct Marks : 4 Wrong Marks : 1

The mean and variance of 20 observations are found to be 10 and 4, respectively. On rechecking, it was found that an observation 9 was incorrect and the correct observation was 11. Then the correct variance is :

Options :

1. 3.98

2. 3.99

3. 4.01

4. 4.02

Question Number : 68 Question Type : MCQ Option Shuffling : Yes

Correct Marks : 4 Wrong Marks : 1

20 પ્રેક્ષણોં કે માધ્ય તથા પ્રસરણ ક્રમશઃ 10 તથા 4 પાચે ગયે। પુનઃ જાંચ કરને પર પાચા ગયા કિ ઁક પ્રેક્ષણ 9 ગલત થા તથા સહી પ્રેક્ષણ 11 થા। તો સહી પ્રસરણ હૈ :

Options :

1. 3.98

2. 3.99

3. 4.01

4. 4.02

Question Number : 68 Question Type : MCQ Option Shuffling : Yes
Correct Marks : 4 Wrong Marks : 1

20 અવલોકનોનાં મધ્યક અને વિચરણ અનુક્રમે 10 અને 4 જોવા મળે છે. પુનઃચકાસણીમાં માલૂમ પડ્યું કે ઁક અવલોકન 9 ખોટું છે અને સાચું અવલોકન 11 છે. તો સાચું વિચરણ શું થશે?

Options :

1. 3.98

2. 3.99

3. 4.01

4. 4.02

Question Number : 69 Question Type : MCQ Option Shuffling : Yes

Correct Marks : 4 Wrong Marks : 1

Let A and B be two events such that the probability that exactly one of them occurs is $\frac{2}{5}$ and the probability that A or B occurs is $\frac{1}{2}$, then the probability of both of them occur together is :

Options :

1. 0.01

2. 0.02

3. 0.10

4. 0.20

Question Number : 69 Question Type : MCQ Option Shuffling : Yes

Correct Marks : 4 Wrong Marks : 1

माना A तथा B दो घटनायें इस प्रकार हैं कि दोनों में से मात्र एक के होने की प्रायिकता $\frac{2}{5}$ है तथा A या B के होने की प्रायिकता $\frac{1}{2}$ है, तो दोनों के एक साथ होने की प्रायिकता है :

Options :

1. 0.01

2. 0.02

3. 0.10

4. 0.20

Question Number : 69 Question Type : MCQ Option Shuffling : Yes

Correct Marks : 4 Wrong Marks : 1

ધારો કે A અને B એવી ઘટનાઓ છે કે જેથી તેમાંની

બરાબર એક ઘટના બનવાની સંભાવના $\frac{2}{5}$ થાય અને

A અથવા B બનવાની સંભાવના $\frac{1}{2}$ થાય તો બંને

ઘટનાઓ સાથે બનવાની સંભાવના કેટલી થાય?

Options :

1. 0.01

2. 0.02

3. 0.10

4. 0.20

Question Number : 70 Question Type : MCQ Option Shuffling : Yes

Correct Marks : 4 Wrong Marks : 1

Which of the following statements is a tautology ?

Options :

1. $P \vee (\sim Q) \rightarrow P \wedge Q$

2. $\sim(P \vee \sim Q) \rightarrow P \wedge Q$

3. $\sim(P \wedge \sim Q) \rightarrow P \vee Q$

4. $\sim(p \vee \sim q) \rightarrow p \vee q$

Question Number : 70 Question Type : MCQ Option Shuffling : Yes

Correct Marks : 4 Wrong Marks : 1

निम्न में से कौन सा कथन एक पुनरुक्ति है?

Options :

1. $p \vee (\sim q) \rightarrow p \wedge q$

2. $\sim(p \vee \sim q) \rightarrow p \wedge q$

3. $\sim(p \wedge \sim q) \rightarrow p \vee q$

4. $\sim(p \vee \sim q) \rightarrow p \vee q$

Question Number : 70 Question Type : MCQ Option Shuffling : Yes

Correct Marks : 4 Wrong Marks : 1

નીચેનામાંથી કયું વિધાન નિત્યસત્ય છે?

Options :

1. $p \vee (\sim q) \rightarrow p \wedge q$

2. $\sim(p \vee \sim q) \rightarrow p \wedge q$

3. $\sim(p \wedge \sim q) \rightarrow p \vee q$

4. $\sim(p \vee \sim q) \rightarrow p \vee q$

Sub-Section Number: 2
Sub-Section Id: 405036109
Question Shuffling Allowed : Yes

Question Number : 71 Question Type : SA
Correct Marks : 4 Wrong Marks : 0

The number of 4 letter words (with or without meaning) that can be formed from the eleven letters of the word 'EXAMINATION' is _____.

Response Type: Numeric
Evaluation Required For SA: Yes
Show Word Count: Yes
Answers Type: Range
Possible Answers :
2454 to 2454

Question Number : 71 Question Type : SA
Correct Marks : 4 Wrong Marks : 0

शब्द 'EXAMINATION' के ग्यारह अक्षरों से बन सकने वाले 4 अक्षरों के शब्दों (अर्थ वाले तथा अर्थविहीन) की संख्या है _____।

Response Type: Numeric
Evaluation Required For SA: Yes
Show Word Count: Yes
Answers Type: Range
Possible Answers :
2454 to 2454

Question Number : 71 Question Type : SA
Correct Marks : 4 Wrong Marks : 0

शब्द 'EXAMINATION' नां अगित्थार अक्षरोमांथी 4 अक्षरो वाणा केटला शब्दो (अर्थ सत्तर के अर्थ रहित) बनावी शक्याय _____.

Response Type: Numeric
Evaluation Required For SA: Yes
Show Word Count: Yes
Answers Type: Range
Possible Answers :
2454 to 2454

Question Number : 72 Question Type : SA
Correct Marks : 4 Wrong Marks : 0

The sum, $\sum_{n=1}^7 \frac{n(n+1)(2n+1)}{4}$ is equal to _____.

Response Type: Numeric

Evaluation Required For SA: Yes

Show Word Count: Yes

Answers Type: Range

Possible Answers :

504 to 504

Question Number : 72 Question Type : SA

Correct Marks : 4 Wrong Marks : 0

योगफल $\sum_{n=1}^7 \frac{n(n+1)(2n+1)}{4}$ बराबर है

_____।

Response Type: Numeric

Evaluation Required For SA: Yes

Show Word Count: Yes

Answers Type: Range

Possible Answers :

504 to 504

Question Number : 72 Question Type : SA

Correct Marks : 4 Wrong Marks : 0

संख्याओं $\sum_{n=1}^7 \frac{n(n+1)(2n+1)}{4} =$ _____.

Response Type: Numeric

Evaluation Required For SA: Yes

Show Word Count: Yes

Answers Type: Range

Possible Answers :

504 to 504

Question Number : 73 Question Type : SA

Correct Marks : 4 Wrong Marks : 0

Let $f(x)$ be a polynomial of degree 3 such that $f(-1) = 10$, $f(1) = -6$, $f(x)$ has a critical point at $x = -1$ and $f'(x)$ has a critical point at $x = 1$. Then $f(x)$ has a local minima at $x =$ _____.

Response Type: Numeric

Evaluation Required For SA: Yes

Show Word Count: Yes

Answers Type: Range

Possible Answers :

3 to 3

Question Number : 73 Question Type : SA

Correct Marks : 4 Wrong Marks : 0

माना घात 3 का एक बहुपद $f(x)$ इस प्रकार है कि $f(-1)=10$, $f(1)=-6$, $f(x)$ का एक क्रांतिक बिन्दु $x=-1$ है तथा $f'(x)$ का एक क्रांतिक बिन्दु $x=1$ है। तो $f(x)$ का एक स्थानीय निम्ननिष्ठ है $x=_____$ ।

Response Type: Numeric

Evaluation Required For SA: Yes

Show Word Count: Yes

Answers Type: Range

Possible Answers :

3 to 3

Question Number : 73 **Question Type :** SA

Correct Marks : 4 **Wrong Marks :** 0

ધારો કે $f(x)$ એ ત્રિઘાત બહુપદી છે કે જેને માટે $f(-1)=10$, $f(1)=-6$, $f(x)$ ને $x=-1$ આગળ નિર્ણાયક બિંદુ છે અને $f'(x)$ ને $x=1$ આગળ નિર્ણાયક બિંદુ છે. તો $f(x)$ ને સ્થાનીય ન્યૂનતમ, $x=_____$ આગળ મળશે.

Response Type: Numeric

Evaluation Required For SA: Yes

Show Word Count: Yes

Answers Type: Range

Possible Answers :

3 to 3

Question Number : 74 **Question Type :** SA

Correct Marks : 4 **Wrong Marks :** 0

Let a line $y=mx$ ($m > 0$) intersect the parabola, $y^2=x$ at a point P, other than the origin. Let the tangent to it at P meet the x-axis at the point Q. If area (ΔOPQ) = 4 sq. units, then m is equal to _____.

Response Type: Numeric

Evaluation Required For SA: Yes

Show Word Count: Yes

Answers Type: Range

Possible Answers :

0.5 to 0.5

Question Number : 74 **Question Type :** SA

Correct Marks : 4 **Wrong Marks :** 0

माना एक रेखा $y=mx$ ($m > 0$), परवलय $y^2=x$ को मूल बिन्दु के अतिरिक्त एक बिन्दु P पर काटती है। माना P पर इसकी स्पर्श रेखा x-अक्ष को बिन्दु Q पर मिलती है। यदि ΔOPQ का क्षेत्रफल 4 वर्ग इकाई है, तो m बराबर है _____।

Response Type: Numeric

Evaluation Required For SA: Yes

Show Word Count: Yes

Answers Type: Range

Possible Answers :

0.5 to 0.5

Question Number : 74 Question Type : SA

Correct Marks : 4 Wrong Marks : 0

ધારો કે રેખા $y = mx$ ($m > 0$) એ પરવલય $y^2 = x$ ને ઉદ્ગમ બિંદુ સિવાયના બિંદુ P માં છેદે છે અને તેને P બિંદુ આગળનો સ્પર્શક x -અક્ષને બિંદુ Q માં મળે છે. જો ΔOPQ નું ક્ષેત્રફળ=4 થો.એકમ હોય તો $m =$ _____.

Response Type: Numeric

Evaluation Required For SA: Yes

Show Word Count: Yes

Answers Type: Range

Possible Answers :

0.5 to 0.5

Question Number : 75 Question Type : SA

Correct Marks : 4 Wrong Marks : 0

If $\frac{\sqrt{2} \sin \alpha}{\sqrt{1 + \cos 2\alpha}} = \frac{1}{7}$ and $\sqrt{\frac{1 - \cos 2\beta}{2}} = \frac{1}{\sqrt{10}}$,

$\alpha, \beta \in \left(0, \frac{\pi}{2}\right)$, then $\tan(\alpha + 2\beta)$ is equal to

_____.

Response Type: Numeric

Evaluation Required For SA: Yes

Show Word Count: Yes

Answers Type: Range

Possible Answers :

1 to 1

Question Number : 75 Question Type : SA

Correct Marks : 4 Wrong Marks : 0

यदि $\frac{\sqrt{2} \sin \alpha}{\sqrt{1 + \cos 2\alpha}} = \frac{1}{7}$ तथा

$\sqrt{\frac{1 - \cos 2\beta}{2}} = \frac{1}{\sqrt{10}}$, $\alpha, \beta \in \left(0, \frac{\pi}{2}\right)$ हैं, तो

$\tan(\alpha + 2\beta)$ बराबर है _____ ।

Response Type: Numeric

Evaluation Required For SA: Yes

Show Word Count: Yes

Answers Type: Range

Possible Answers :

1 to 1

Question Number : 75 Question Type : SA

Correct Marks : 4 Wrong Marks : 0

$$\text{જો } \frac{\sqrt{2} \sin \alpha}{\sqrt{1 + \cos 2\alpha}} = \frac{1}{7} \text{ અને}$$

$$\sqrt{\frac{1 - \cos 2\beta}{2}} = \frac{1}{\sqrt{10}}, \text{ જ્યાં } \alpha, \beta \in \left(0, \frac{\pi}{2}\right) \text{ હોય}$$

$$\text{તો } \tan(\alpha + 2\beta) = \underline{\hspace{2cm}} \text{ થાય.}$$

Response Type: Numeric

Evaluation Required For SA: Yes

Show Word Count: Yes

Answers Type: Range

Possible Answers :

1 to 1