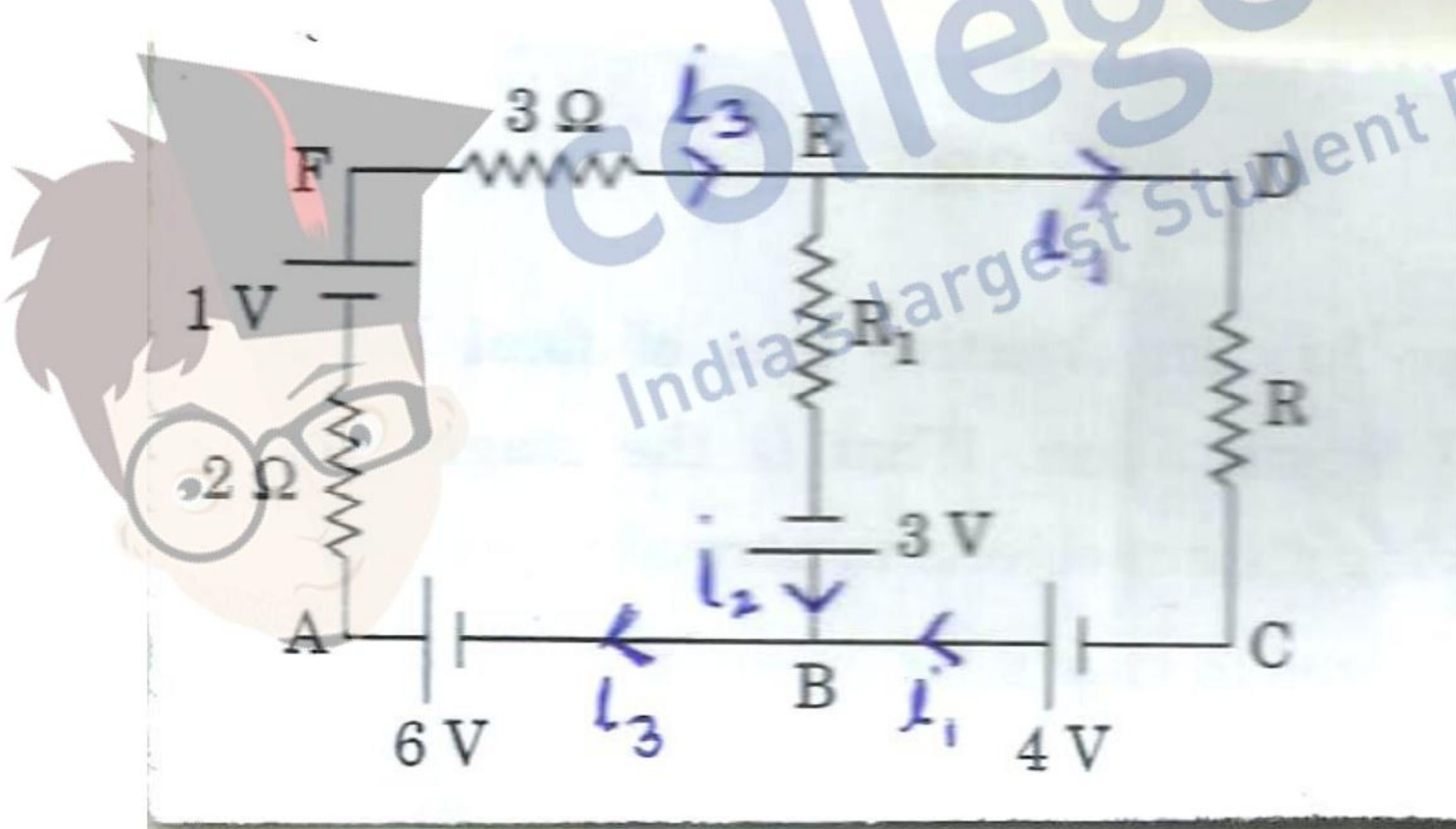

MARKING SCHEME
SET 55/1/RU

Q. No.	Expected Answer / Value Points	Marks	Total Marks								
Section A											
Set1, Q1 Set2, Q5 Set3, Q4	Self inductance of the coil is numerically equal to magnetic flux linked with it when unit current flows through it. / Self inductance is numerically equal to induced emf in the coil when rate of change of current is unity. Unit- Henry or / volt-second/ ampere / weber ampere ⁻¹	1/2 1/2	1								
Set1, Q2 Set 2, Q3 Set 3, Q1	Scattering of the blue colour is maximum due to its shorter wavelength / As per Rayleigh scattering law, the amount of scattering varies inversely with the fourth power of wavelength.	1	1								
Set1, Q3 Set 2, Q4 Set 3, Q5	T ₁ Since slope(= $\frac{1}{Resistance}$) of T ₁ is greater / Resistance of the wire at T ₁ is lower.	1/2 1/2	1								
Set1, Q4 Set 2, Q2 Set 3, Q3	Point to Point communication mode	1	1								
Set1, Q5 Set 2, Q1 Set 3, Q2	Due to conservative nature of electric field / These lines start from the positive charges and terminate at the negative charges. Alternatively, There are two kinds of electric charges (positive and negative) (which acts as the 'source' and 'sink' for the electric field lines.)	1	1								
Section B											
Set1, Q6 Set 2, Q8 Set 3, Q10	<table border="1" style="width: 100%; border-collapse: collapse;"> <tr> <td>Formula for Energy</td> <td style="text-align: right;">1/2</td> </tr> <tr> <td>Formula for de-Broglie wavelength</td> <td style="text-align: right;">1/2</td> </tr> <tr> <td>Calculation</td> <td style="text-align: right;">1/2</td> </tr> <tr> <td>Effect on wavelength</td> <td style="text-align: right;">1/2</td> </tr> </table> $\lambda = \frac{h}{p} = \frac{h}{\sqrt{2mK}}$ $\frac{\lambda_1}{\lambda_4} = \sqrt{\frac{K_4}{K_1}}$ But $K_n (= -E_n) \propto \frac{1}{n^2}$ Hence, $\frac{\lambda_1}{\lambda_4} = \sqrt{\frac{1}{16}}$ $\therefore \frac{\lambda_1}{\lambda_4} = \frac{1}{4}$ $\lambda_4 = 4\lambda_1$ i.e. $\lambda_4 > \lambda_1$	Formula for Energy	1/2	Formula for de-Broglie wavelength	1/2	Calculation	1/2	Effect on wavelength	1/2	1/2 1/2 1/2 1/2	
Formula for Energy	1/2										
Formula for de-Broglie wavelength	1/2										
Calculation	1/2										
Effect on wavelength	1/2										

	<p><u>Alternatively</u></p> $\lambda_n = \frac{h}{p_n} = \frac{h}{mv_n}$ <p>Velocity of electron in n^{th} state $v_n \propto \frac{1}{n}$</p> $\lambda_n \propto \frac{1}{v_n} \therefore \lambda \propto n$ $\therefore \frac{\lambda_4}{\lambda_1} = \frac{n_4}{n_1} = \frac{4}{1}$	<p>1/2</p> <p>1/2</p> <p>1/2</p> <p>1/2</p>	<p>2</p> <p>2</p>						
<p>Set1, Q7 Set 2,Q6 Set 3,Q9</p>	<table border="1" style="width: 100%;"> <tr> <td style="width: 60%;">Any two Factors</td> <td style="width: 40%;">1 + 1</td> </tr> </table> <ol style="list-style-type: none"> 1. Size of the antenna or aerial or ($L \sim \frac{\lambda}{4}$) 2. Increase in effective power radiated by an Antenna (OR Power radiated $\propto \left(\frac{1}{\lambda}\right)^2$) 3. To minimize mixing of signals from different transmitters (Any two) 	Any two Factors	1 + 1	<p>1 + 1</p>	<p>2</p>				
Any two Factors	1 + 1								
<p>Set1, Q8 Set 2,Q9 Set 3,Q7</p>	<table border="1" style="width: 100%;"> <tr> <td style="width: 60%;">Labeling of current in different branches of the circuit</td> <td style="width: 40%;">1/2</td> </tr> <tr> <td>Calculation</td> <td>1</td> </tr> <tr> <td>Result</td> <td>1/2</td> </tr> </table>  <p>According to Kirchoff's Junction law at B</p> $i_3 = i_1 + i_2 \quad \therefore i_3 = i_1$ <p>(As $i_2=0$ (given))</p> <p>Applying second law to loop AFEB</p> $i_3 \times 2 + i_3 \times 3 + i_2 R_1 = 1 + 3 + 6$ $\therefore i_3 = i_1 = 2 \text{ A}$ <p>From A to D along AFD $\therefore V_{AD} = 2i_3 - 1 + 3 \times i_3$</p> $= (4 - 1 + 6)V$ $= 9 \text{ V}$ <p>[Alternatively, if the student determine value of V_{AD} by finding the value of R, award full marks.]</p> <p>[Note: If the student just writes Kirchoff's rules, award 1/2 mark]</p>	Labeling of current in different branches of the circuit	1/2	Calculation	1	Result	1/2	<p>1/2</p> <p>1/2</p> <p>1/2</p>	<p>2</p>
Labeling of current in different branches of the circuit	1/2								
Calculation	1								
Result	1/2								

Set1, Q9
Set 2, Q10
Set 3, Q8

Formula for magnification	1/2
Substitution and Calculation	1
Result	1/2

$$M = m_o \times m_e$$

$$= \frac{L}{f_o} \left(1 + \frac{D}{f_e}\right)$$

$$\therefore 30 = \frac{L}{1.25} \left(1 + \frac{25}{5}\right)$$

$$30 \times 1.25 = L \times 6$$

$$L = 5 \times 1.25$$

$$= 6.25 \text{ cm}$$

1/2
1/2
1/2
1/2

2

OR

Formula for magnification	1/2
Calculation & Result	1/2
Angular magnification	1/2
Height of image	1/2

For objective lens,



$$M = \frac{f_o}{f_e}$$

$$\therefore M = \frac{150}{5} = 30$$

$$\frac{1}{v_o} - \frac{1}{u_o} = \frac{1}{f_o}$$

$$\frac{1}{v_o} = \frac{1}{1.5} - \frac{1}{3000}$$

$$\therefore v_o = \frac{3000}{1999} \approx 1.5$$

1/2
1/2
1/2

$$\frac{h_i}{h_o} = \frac{v_o}{u_o}$$

$$h_i = 100 \times \frac{1.5}{3 \times 10^3} = .05 \text{ m}$$

1/2

Alternatively,

Angular size of the object = $\frac{100}{3 \times 1000}$ radian = $\frac{1}{30}$ radian

\therefore Angular size of image = $\left(\frac{1}{30} \times 30\right)$ radian = 1 radian

\therefore Height of image = $1 \times \left(\frac{5}{100}\right)$ m = 0.05 m

1/2
1/2
1

2

Set1, Q10
Set 2, Q7
Set 3, Q6

Formula	1/2
Substitution of correct value in formula	1/2
Value of λ	1/2
Region of wavelength	1/2

$$\frac{1}{\lambda} = R \left(\frac{1}{n_1^2} - \frac{1}{n_2^2} \right)$$

For shortest wavelength in Balmer series

$$n_1 = 2 \quad n_2 = \infty$$

1/2



$\therefore \frac{1}{\lambda} = R \left(\frac{1}{4} - \frac{1}{\infty} \right)$ $= \frac{R}{4}$ $\lambda = 3640 \text{ \AA}$ $\therefore R = 1.09 \times 10^7 \text{ m}^{-1}$ <p>[Note: Since the value of R is not given, award full marks to the candidate if he writes $\lambda = \frac{4}{R}$] It will lie in Ultra Violet region (Give ½ mark if the student just writes, visible region)</p>	½	½	½	
--	---	---	---	--

Section C

Set1, Q11 Set 2,Q18 Set 3,Q15	<table border="1" style="width: 100%;"> <tr> <td>Formula for net capacitance and its calculation</td> <td style="text-align: right;">½ + ½</td> </tr> <tr> <td>Calculation for net charge</td> <td style="text-align: right;">½</td> </tr> <tr> <td>Formula and calculation for P.d</td> <td style="text-align: right;">½</td> </tr> <tr> <td>Formula and calculation for energy stored</td> <td style="text-align: right;">½ + ½</td> </tr> </table> <p>Net Capacitance , $\frac{1}{C} = \frac{1}{C_1} + \frac{1}{C_2} + \frac{1}{C_3}$</p> $\frac{1}{C} = \frac{1}{20} + \frac{1}{30} + \frac{1}{15}$ $\therefore C = \frac{20}{3} \mu F$ <p>Net Charge on Capacitors $q = CV$ $= \frac{20}{3} \times 10^{-6} \times 90 \text{ C}$ $= 600 \times 10^{-6} \text{ C}$ $= 600 \mu \text{ C (0.6 mC)}$</p> $\therefore \text{P. d across } C_2 = \frac{q}{C_2}$ $= \frac{600 \times 10^{-6}}{30 \times 10^{-6}} \text{ V}$ $= 20 \text{ V}$ <p>Energy stored in capacitor across $C_2 = \frac{1}{2} C_2 V_2^2$</p> $= \frac{1}{2} \times 30 \times 10^{-6} \times 400$ $= 6 \times 10^{-3} \text{ J (= 6mJ)}$	Formula for net capacitance and its calculation	½ + ½	Calculation for net charge	½	Formula and calculation for P.d	½	Formula and calculation for energy stored	½ + ½	½	½	½	½	½	½	3
Formula for net capacitance and its calculation	½ + ½															
Calculation for net charge	½															
Formula and calculation for P.d	½															
Formula and calculation for energy stored	½ + ½															

Set1, Q12 Set 2,Q19 Set 3,Q16	<table border="1" style="width: 100%;"> <tr> <td>Derivation of the Relation</td> <td style="text-align: right;">2</td> </tr> <tr> <td>Effect on drift velocity</td> <td style="text-align: right;">1</td> </tr> </table> <p>There being a random distribution, in the velocities of the charge carriers, their average velocity can be taken to be zero. We have, $F = ma = e F_E$ (F_E =electric field)</p> $\therefore a = \frac{eF_E}{m}$ <p>If τ is the average time between collisions (called ‘relaxation time’)</p>	Derivation of the Relation	2	Effect on drift velocity	1	½	½	½		
Derivation of the Relation	2									
Effect on drift velocity	1									



	$v_d = \frac{eF_E\tau}{m}$ <p>Now, $F_E = \frac{P.D}{\text{distance}} \therefore$ For given E, the field becomes $\frac{1}{3}rd$ when the length is made 3 times. Hence, $v'_d(\text{New}) = \frac{1}{3}v_d$</p> $\therefore v_{d'} = \frac{v_d}{3}$ <p>[Note: If explained by any other appropriate method award 1 mark for the explanation]</p>	1/2 1/2 1/2	3								
Set1, Q13 Set 2, Q20 Set 3, Q17	<table border="1"> <tbody> <tr> <td>Explanation of Polarization through polarizer</td> <td>1</td> </tr> <tr> <td>Variation in I_1 and I_2</td> <td>1</td> </tr> <tr> <td>Relation between I_1 and I_2</td> <td>1</td> </tr> </tbody> </table> <p>Let unpolarized light be incident on a polaroid; its electric vectors, oscillating in a direction perpendicular to that of the alignment of the molecules in the polaroid, are able to pass through it while the component of light along the aligned molecules gets blocked. Hence the light gets linearly polarised.</p> <p>[Note : If student gives labelled diagram, award full marks.]</p> <p>I_1 will remain unaffected whereas I_2 will decrease from maximum ($=I_0/2$) to zero of the incident light. ($I_1 = \frac{I_0}{2}$)</p> $I_2 = I_1 \cos^2 \theta \quad / \quad I_2 = (I_0 / 2) \cos^2 \theta$	Explanation of Polarization through polarizer	1	Variation in I_1 and I_2	1	Relation between I_1 and I_2	1	1 1 1	3		
Explanation of Polarization through polarizer	1										
Variation in I_1 and I_2	1										
Relation between I_1 and I_2	1										
Set1, Q14 Set 2, Q21 Set 3, Q18	<table border="1"> <tbody> <tr> <td>Definition of Modulation index</td> <td>1</td> </tr> <tr> <td>Reason</td> <td>1/2</td> </tr> <tr> <td>Calculation of USB and LSB</td> <td>1/2 + 1/2</td> </tr> <tr> <td>Amplitude of AM</td> <td>1/2</td> </tr> </tbody> </table> <p>The ratio of amplitude of modulating signal (E_m) and amplitude of carrier wave (E_c) is called modulating index.</p> <p>[Note: Also accept if only the formula ($\mu = \frac{E_m}{E_c}$) is given]</p> <p>To avoid /minimize distortion: Given: $f_c = 1.5 \text{ MHz}$ $f_m = 10 \text{ kHz} = 0.01 \text{ MHz}$</p> $\therefore \mu = \frac{E_m}{E_c}$ $\frac{50}{100} = \frac{E_m}{50}$ $E_m = 25 \text{ V}$ <p>USB frequency = $f_c + f_m$ $= (1.5 + 0.01) \text{ MHz}$ $= 1.51 \text{ MHz}$</p> <p>LSB frequency = $f_c - f_m$ $= (1.5 - 0.01) \text{ MHz}$ $= 1.49 \text{ MHz}$</p>	Definition of Modulation index	1	Reason	1/2	Calculation of USB and LSB	1/2 + 1/2	Amplitude of AM	1/2	1 1/2 1/2 1/2	3
Definition of Modulation index	1										
Reason	1/2										
Calculation of USB and LSB	1/2 + 1/2										
Amplitude of AM	1/2										



Set1, Q15
Set 2, Q22
Set 3, Q11

Trajectory of particle	1
Reason /explanation	1
Expression for distance travelled	1

Trajectory will be a helix

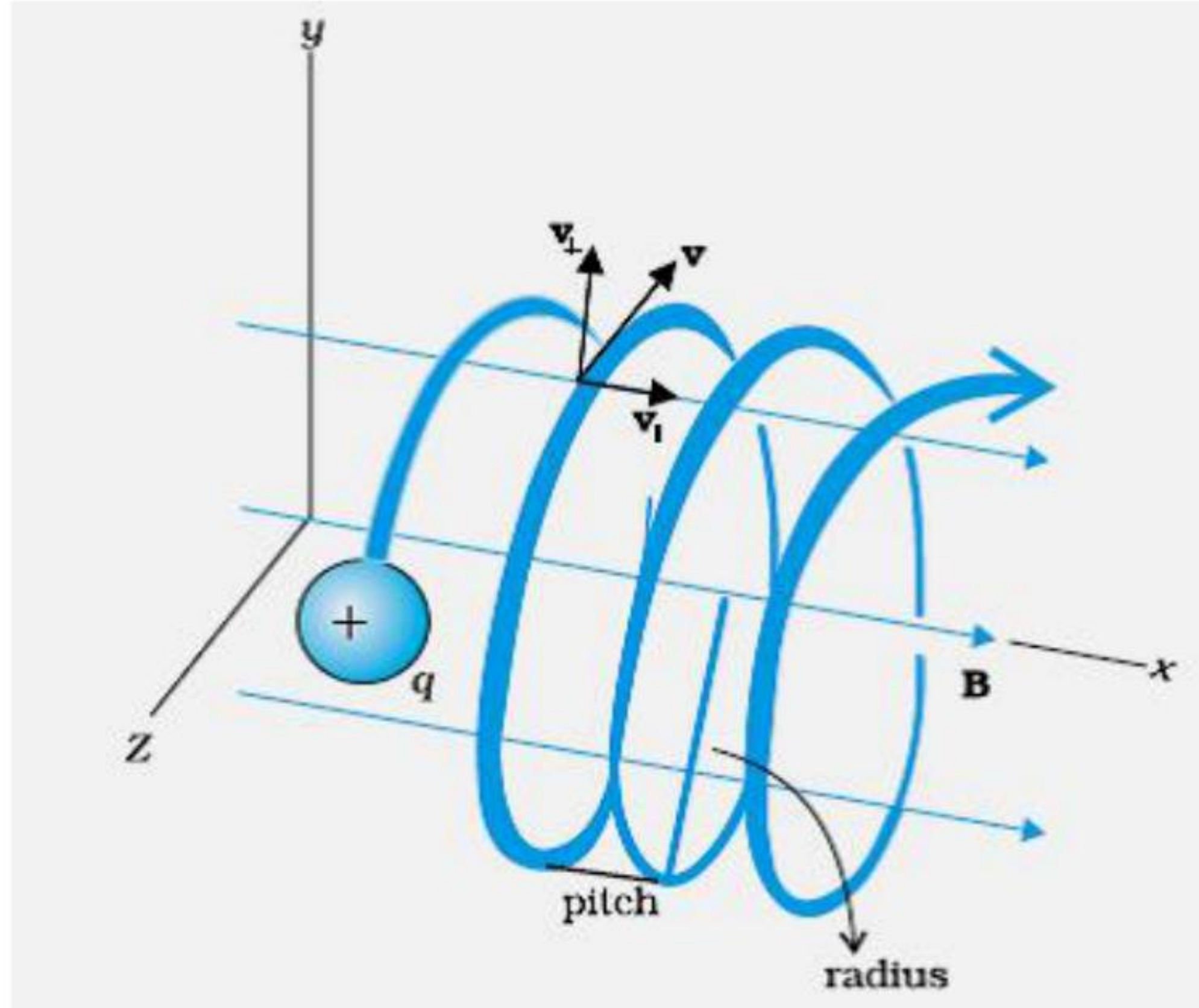

Explanation/Reason

The particle will describe a circle in the y-z plane, due to the component, v_y , of its velocity. It also moves along the x-axis (parallel to the field), due to the component v_x of its velocity. Hence its trajectory would be helical.

Distance moved along the magnetic field in one rotation

$$x = v_x \times T$$

$$\therefore T = \frac{2\pi m}{Bq}$$

$$\therefore x = \frac{2\pi m v_p}{Bq}$$



collegedunia.com
India's largest Student Review Platform

1

1

1/2

1/2

3

Set1, Q16
Set 2, Q14
Set 3, Q12

(a) Value of phase difference	2
(b) Value of additional Capacitance	1

(a) In LCR circuit

$$\tan \varphi = \frac{X_L - X_C}{R} = \frac{\omega L - \frac{1}{\omega C}}{R}$$

$$\text{Now } X_L = \omega L = (1000 \times 100 \times 10^{-3}) \Omega = 100 \Omega$$

$$\text{and } X_C = \frac{1}{\omega C} = \left(\frac{1}{1000 \times 2 \times 10^{-6}} \right) \Omega$$

$$\therefore X_C = 500 \Omega$$

$$\therefore \tan \varphi = \frac{500 - 100}{400} = 1$$

$$\tan \varphi = 1$$

$$\varphi = 45^\circ$$

1/2

1/2

1/2

1/2

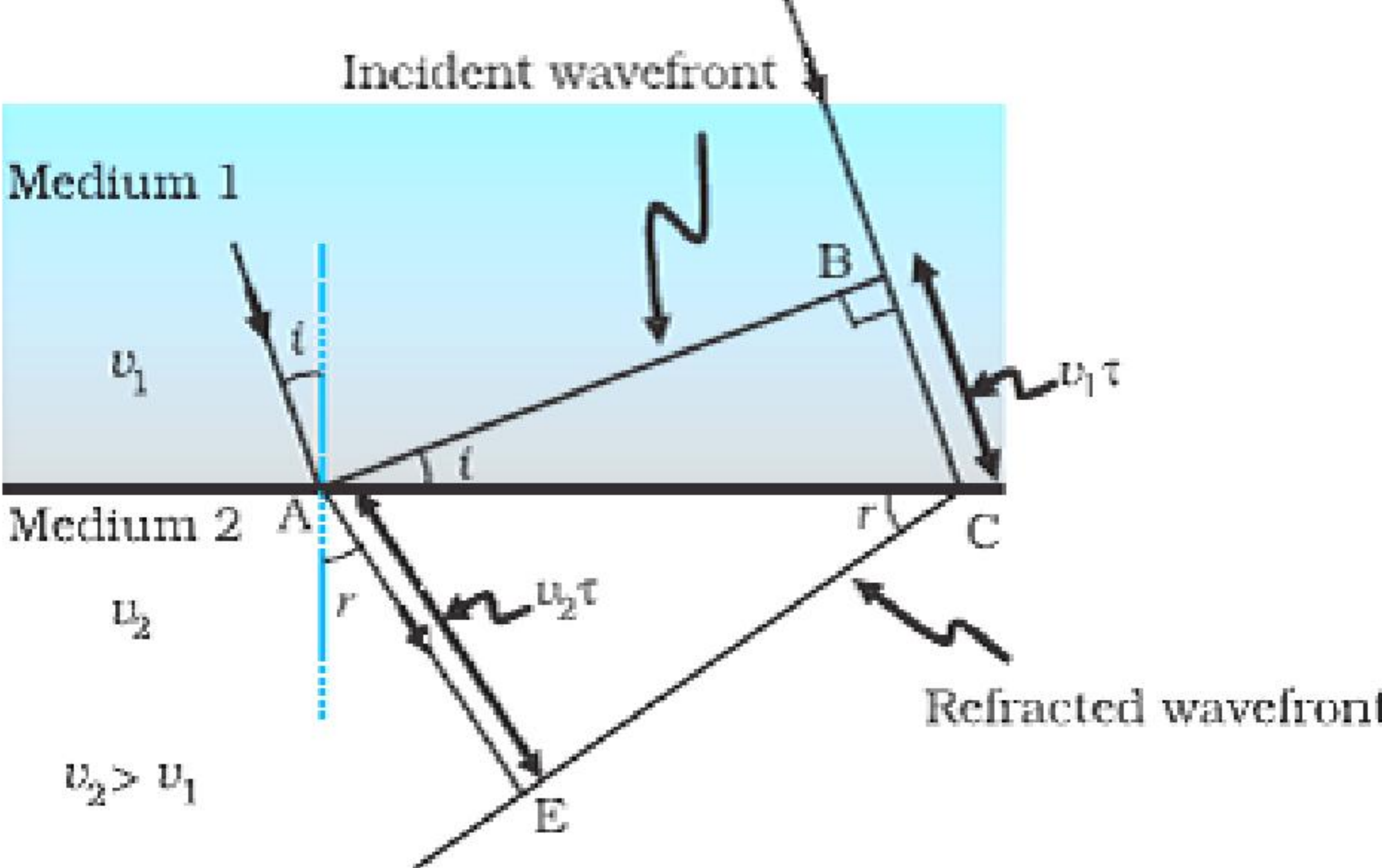

	<p>(b) Power Factor When power factor=1, we have $X_L=X_C$</p> $\therefore X'_C = \frac{1}{\omega C'} = 100\Omega$ <p>This gives $C' = \frac{1}{100\omega} = 10\mu F$ We, therefore, need to add a capacitor of capacitance $(10-2)\mu F=8\mu F$ in parallel with the given capacitor. Alternatively, Let addition capacitance C_1 be connected</p> $X'_C = \frac{1}{1000(2 + C_1) \times 10^{-6}}$ $\therefore 100 = \frac{1}{1000(2 + C_1) \times 10^{-6}}$ $\therefore 2 + C_1 = 10$ $C_1 = 8 \mu F$	<p>1/2 1/2 1/2 1/2</p>	<p>3</p>						
<p>Set1, Q17 Set 2,Q15 Set 3,Q13</p>	<table border="1" data-bbox="332 1143 1528 1305"> <tbody> <tr> <td>Generalized form of Ampere's Circuital law</td> <td>1</td> </tr> <tr> <td>Significance</td> <td>1</td> </tr> <tr> <td>Explanation</td> <td>1</td> </tr> </tbody> </table> <p>Generalized form of Ampere Circuital law:</p> $\oint \vec{B} \cdot d\vec{l} = \mu_o \left(I_c + \epsilon_o \frac{d\phi}{dt} \right)$ <p>It signifies that the source of magnetic field is not just due to the conduction electric current(i_c) due to flow of charge but also due to the time rate of change of electric field called displacement current .</p> <p>During charging and discharging of a capacitor the electric field between the plates will change so there will be a change of electric flux (displacement current) between the plates.</p>	Generalized form of Ampere's Circuital law	1	Significance	1	Explanation	1	<p>1 1 1</p>	<p>3</p>
Generalized form of Ampere's Circuital law	1								
Significance	1								
Explanation	1								
<p>Set1, Q18 Set 2,Q16 Set 3,Q14</p>	<table border="1" data-bbox="322 1849 1512 1958"> <tbody> <tr> <td>Labelled Diagram</td> <td>1</td> </tr> <tr> <td>Verification of Snell's law</td> <td>2</td> </tr> </tbody> </table>  <p>In ΔABC</p> $\sin i = \frac{BC}{AC} = \frac{v_1 t}{v_2 t}$	Labelled Diagram	1	Verification of Snell's law	2	<p>1 1/2</p>			
Labelled Diagram	1								
Verification of Snell's law	2								

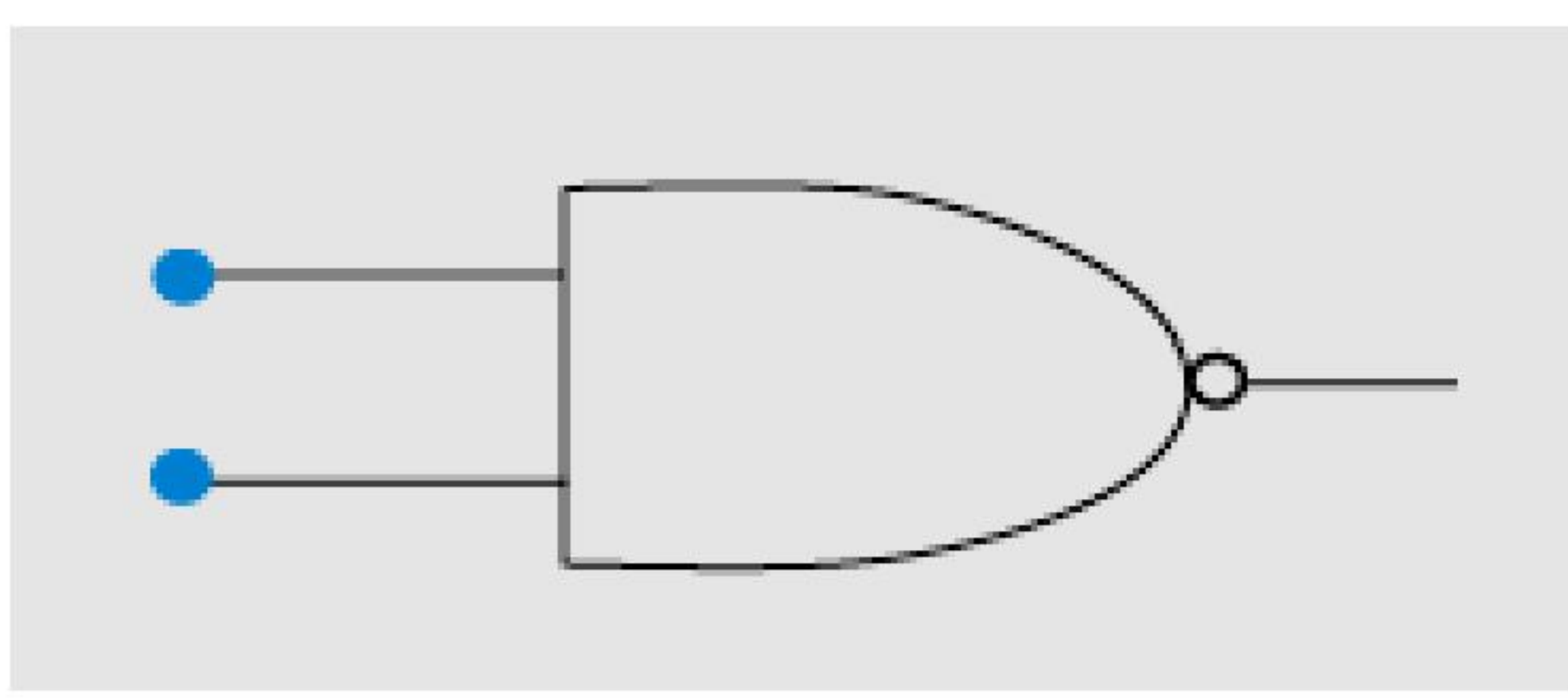
	<p>In Δ CEA</p> $\sin r = \frac{AE}{AC} = \frac{v_2 t}{AC}$ $\therefore \frac{\sin i}{\sin r} = \frac{BC}{AE} = \frac{v_1 t}{v_2 t} = \frac{v_1}{v_2}$ $\therefore \mu_1 = \frac{c}{v_1}$ $\mu_2 = \frac{c}{v_2}$ $\therefore \frac{\mu_2}{\mu_1} = \frac{v_1}{v_2}$ $\therefore \frac{\sin i}{\sin r} = \frac{\mu_2}{\mu_1}$ <p>or $\mu_2 \sin r = \mu_1 \sin i$ ----- It is Snell's law.</p>	<p>$\frac{1}{2}$</p> <p>$\frac{1}{2}$</p> <p>$\frac{1}{2}$</p>	<p>3</p>																																		
<p>Set1, Q19 Set 2, Q17 Set 3, Q21</p>	<table border="1" data-bbox="322 1274 1522 1491"> <tr> <td>Name of Gates P and Q</td> <td>$\frac{1}{2} + \frac{1}{2}$</td> </tr> <tr> <td>Truth Table</td> <td>1</td> </tr> <tr> <td>Equivalent Gate</td> <td>$\frac{1}{2}$</td> </tr> <tr> <td>Logic symbol of equivalent Gate</td> <td>$\frac{1}{2}$</td> </tr> </table> <p>Gate P : AND Gate Q: NOT</p> <table border="1" data-bbox="433 1647 1421 2004"> <thead> <tr> <th colspan="4">Truth table</th> </tr> <tr> <th colspan="2">Input</th> <th rowspan="2">X</th> <th rowspan="2">Y</th> </tr> <tr> <th>A</th> <th>B</th> </tr> </thead> <tbody> <tr> <td>0</td> <td>0</td> <td>0</td> <td>1</td> </tr> <tr> <td>0</td> <td>1</td> <td>0</td> <td>1</td> </tr> <tr> <td>1</td> <td>0</td> <td>0</td> <td>1</td> </tr> <tr> <td>1</td> <td>1</td> <td>1</td> <td>0</td> </tr> </tbody> </table> <p>Equivalent Gate: NAND</p> 	Name of Gates P and Q	$\frac{1}{2} + \frac{1}{2}$	Truth Table	1	Equivalent Gate	$\frac{1}{2}$	Logic symbol of equivalent Gate	$\frac{1}{2}$	Truth table				Input		X	Y	A	B	0	0	0	1	0	1	0	1	1	0	0	1	1	1	1	0	<p>$\frac{1}{2}$</p> <p>$\frac{1}{2}$</p> <p>1</p> <p>$\frac{1}{2}$</p> <p>$\frac{1}{2}$</p>	<p>3</p>
Name of Gates P and Q	$\frac{1}{2} + \frac{1}{2}$																																				
Truth Table	1																																				
Equivalent Gate	$\frac{1}{2}$																																				
Logic symbol of equivalent Gate	$\frac{1}{2}$																																				
Truth table																																					
Input		X	Y																																		
A	B																																				
0	0	0	1																																		
0	1	0	1																																		
1	0	0	1																																		
1	1	1	0																																		
<p>Set1, Q20 Set 2, Q11 Set 3, Q22</p>	<table border="1" data-bbox="312 2408 1512 2626"> <tr> <td>Labeled Circuit diagram</td> <td>1</td> </tr> <tr> <td>Working of Amplifier</td> <td>1</td> </tr> <tr> <td>Expression for voltage gain</td> <td>$\frac{1}{2}$</td> </tr> <tr> <td>Expression for current gain</td> <td>$\frac{1}{2}$</td> </tr> </table>	Labeled Circuit diagram	1	Working of Amplifier	1	Expression for voltage gain	$\frac{1}{2}$	Expression for current gain	$\frac{1}{2}$																												
Labeled Circuit diagram	1																																				
Working of Amplifier	1																																				
Expression for voltage gain	$\frac{1}{2}$																																				
Expression for current gain	$\frac{1}{2}$																																				

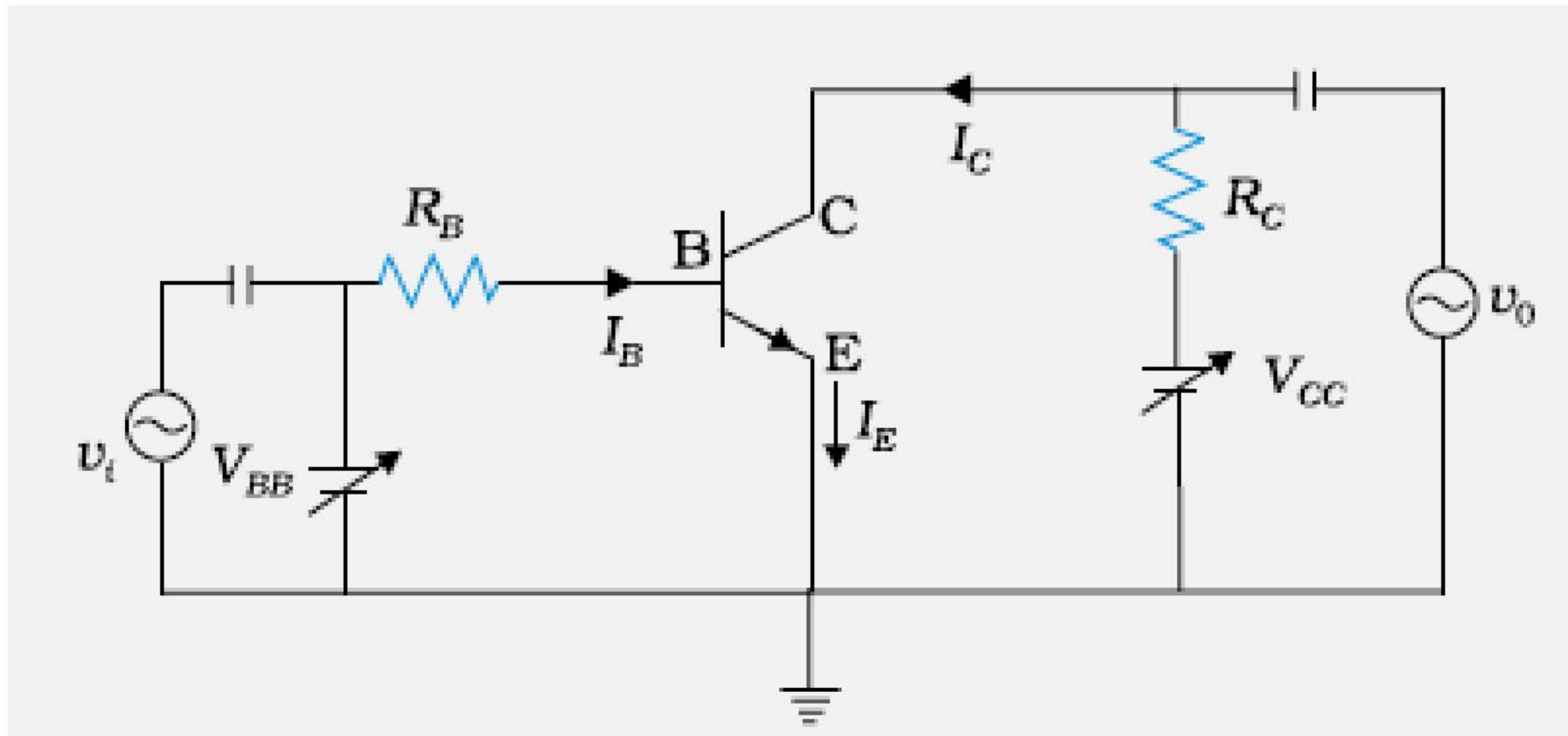

The input signal, connected between the emitter and base, along with the forward bias, causes corresponding large changes in output voltage across R.

Current gain

$$\beta_{ac} = \left| \frac{\Delta I_C}{\Delta I_B} \right|$$

Voltage gain

$$V_{Gain} = \frac{\Delta V_o}{\Delta V_i}$$

1

1

1/2

1/2

3

Set1, Q21
Set 2, Q12
Set 3, Q19

Three characteristic properties
Graph for potential energy
Two conclusions

1/2 + 1/2 + 1/2

1/2

1/2 + 1/2

(a) Characteristic properties of Nuclear force

- i) Short range force
 - ii) Saturation forces
 - iii) Very Strong force
 - iv) Charge independent
- (Any Three)

1/2

+1/2+1/2

(b)

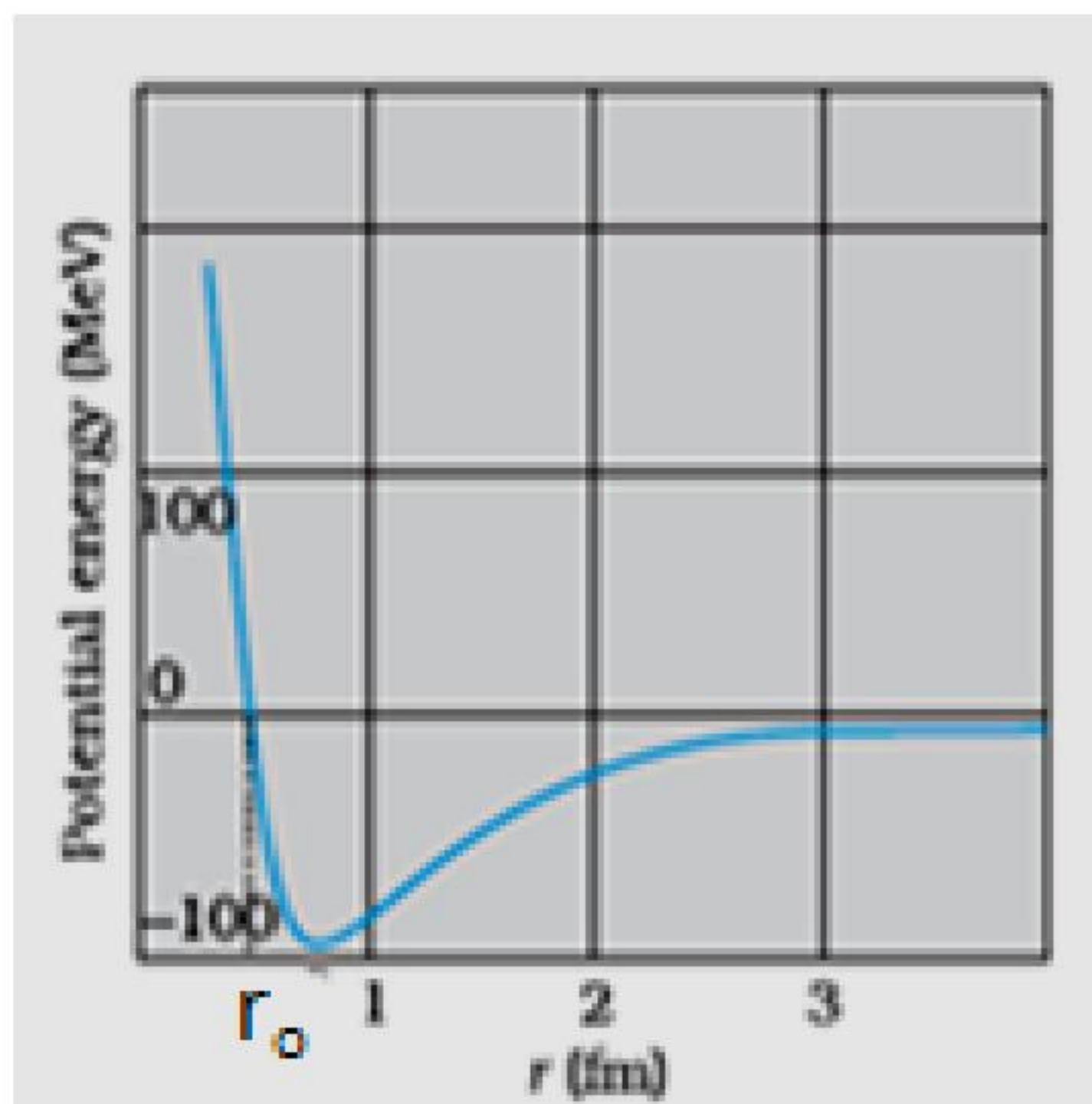

1/2

Conclusions

- i) Nuclear force is attractive for distance larger than r_0
 - ii) Nuclear force is repulsive if two nucleons are separated by distance less than r_0
 - iii) Nuclear force decreases very rapidly for $r > r_0$
 - iv) Potential energy is minimum at r_0 / Equilibrium position
- (any two)

1/2 + 1/2

3



Set1, Q22
Set 2, Q13
Set 3, Q20

(a) Three experimental observations	$\frac{1}{2} + \frac{1}{2} + \frac{1}{2}$
(b) Failure of wave theory	$1 \frac{1}{2}$

- (a) 1. There is no emission of photoelectrons i.e. no current if the frequency of the incident radiation is below a certain minimum value however large may be the intensity of the light.
2 The current varies directly with the intensity of the incident radiation.
3. The current becomes zero at a certain value of negative potential, applied at the anode, this is known as stopping potential.
4. The value of stopping potential increases with the increase in the frequency of the incident radiation.
5. Maximum kinetic energy of the photo electrons does not depend upon intensity of light.
6. Maximum kinetic energy of photoelectron increases with the frequency of the incident radiation.
7. The process of photoelectric emission is instantaneous.

$\frac{1}{2} +$
 $\frac{1}{2} +$
 $\frac{1}{2}$

(Any three)

(b) It fails to explain why

1. The photo electric emission is instantaneous.
2. There exists a threshold frequency for a given metal.
3. The maximum KE of photoelectrons is independent of the intensity of incident radiation.

$1 \frac{1}{2}$

OR

(a) Two properties of photon	$\frac{1}{2} + \frac{1}{2}$
(b) Eienstein equation	1
Explanation of threshold frequency	$\frac{1}{2}$
Stopping potential	$\frac{1}{2}$

(a)

- i) The energy of a photon is $h\nu$
ii) Each photon is completely absorbed by a single electron.

$\frac{1}{2} + \frac{1}{2}$

(b) $E_K = h\nu - W$

Alternatively, $h\nu = h\nu_0 + \frac{1}{2}mv_{max}^2$ or $h\nu = h\nu_0 + eV_0$

or $E_k = h(\nu - \nu_0)$

(Any one)

1

- i. When Incident frequency $<$ Threshold frequency, there will be no emission of electrons. Hence, frequency of incident radiation should be greater than threshold frequency. $(\nu_0 = \frac{W}{h})$

$\frac{1}{2}$

$$E_K = eV_0 = h\nu - W$$

$$\therefore V_0 = \frac{h}{e}\nu - \frac{W}{e}$$

- ii. At $\nu = \nu_0$, $E_k = eV_0 = 0$
 V_0 is called stopping potential.

$\frac{1}{2}$

3

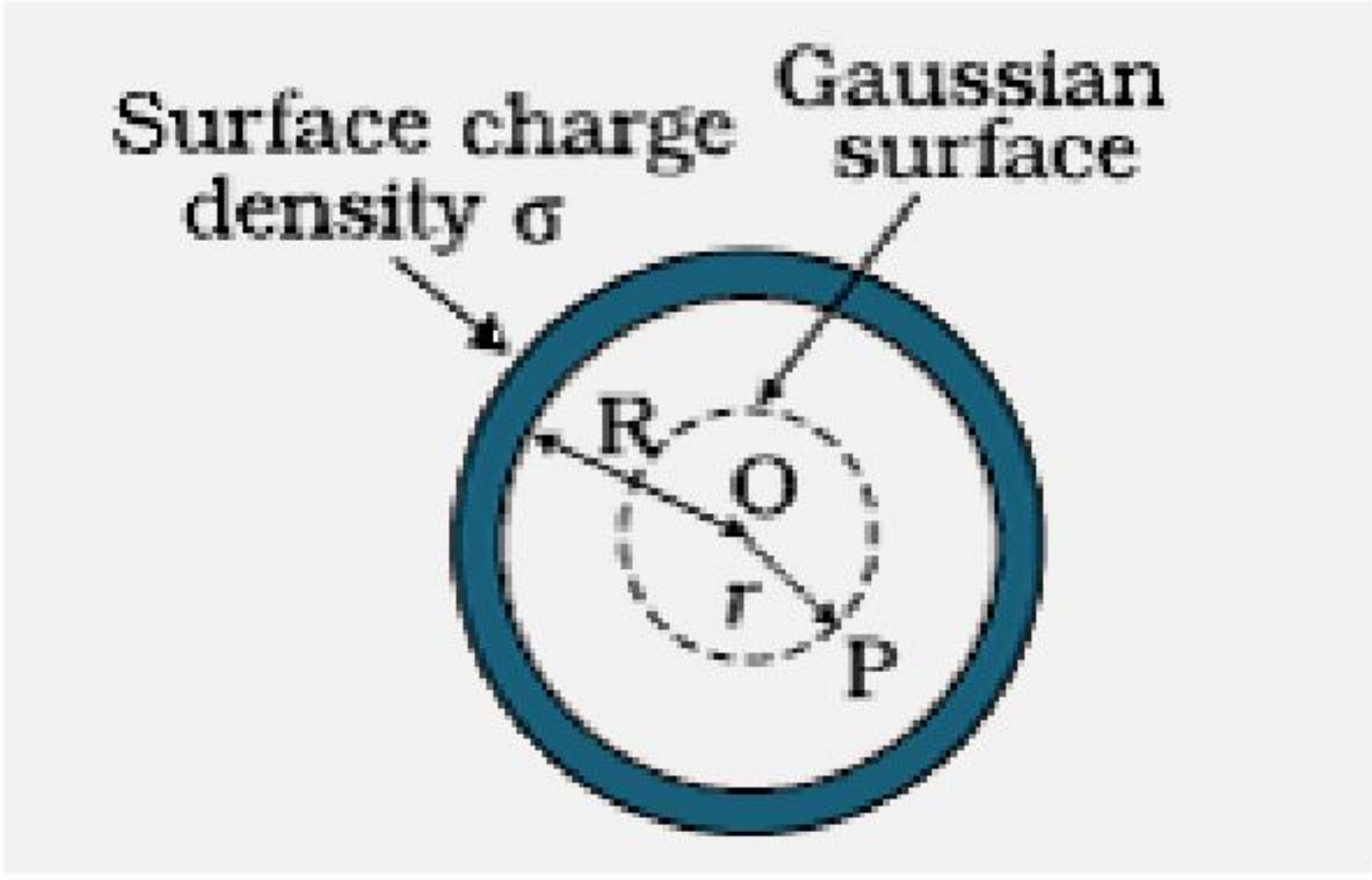

Section D											
Set1, Q23 Set 2,Q23 Set 3,Q23	<table border="1"> <tr> <td>Value of voltage and frequency in India</td> <td>$\frac{1}{2} + \frac{1}{2}$</td> </tr> <tr> <td>Reason of A.C being used more</td> <td>$\frac{1}{2}$</td> </tr> <tr> <td>Use of transformer with D.C</td> <td>$\frac{1}{2}$</td> </tr> <tr> <td>Two qualities of Anil</td> <td>1+ 1</td> </tr> </table>	Value of voltage and frequency in India	$\frac{1}{2} + \frac{1}{2}$	Reason of A.C being used more	$\frac{1}{2}$	Use of transformer with D.C	$\frac{1}{2}$	Two qualities of Anil	1+ 1		
Value of voltage and frequency in India	$\frac{1}{2} + \frac{1}{2}$										
Reason of A.C being used more	$\frac{1}{2}$										
Use of transformer with D.C	$\frac{1}{2}$										
Two qualities of Anil	1+ 1										
	(i) voltage = 220 V frequency = 50 Hz	$\frac{1}{2}$ $\frac{1}{2}$									
	(ii) a) It can be stepped up / stepped down b)It can be converted into d.c c)Line losses can be minimised (any one)	$\frac{1}{2}$ $\frac{1}{2}$									
	(iii) No	$\frac{1}{2}$									
	(iv) Helping / Brave / Kind / Knowledge about AC or DC / Knowledge about insulator & conductors/ Awareness about safety precautions. (any two)	1+1	3								

Section E									
Set1, Q24 Set 2,Q25 Set 3,Q26	<table border="1"> <tr> <td>(a) Definition of electric flux and unit</td> <td>1 + $\frac{1}{2}$</td> </tr> <tr> <td>Justification</td> <td>$1\frac{1}{2}$</td> </tr> <tr> <td>(b) Proof</td> <td>1+1</td> </tr> </table>	(a) Definition of electric flux and unit	1 + $\frac{1}{2}$	Justification	$1\frac{1}{2}$	(b) Proof	1+1		
(a) Definition of electric flux and unit	1 + $\frac{1}{2}$								
Justification	$1\frac{1}{2}$								
(b) Proof	1+1								
	a) Total number of electric lines of force passing perpendicular through a given surface. Unit – newton m ² / coulomb (or V-m)	1 $\frac{1}{2}$							
	According to Gauss theorem, the electric flux through a closed surface depends only on the net charge enclosed by the surface and not upon the shape or size of the surface.	$\frac{1}{2}$							
	For any closed arbitrary slope of the surface enclosing a charge the outward flux is the same as that due to a spherical Gaussian surface enclosing the same charge.	1							
	Justification: This is due to the fact (i) electric field is radial and (ii) the electric field $E \propto \frac{1}{R^2}$								
	b)								
									
	∴ According to Gauss theorem , $\oint \vec{E} \cdot \vec{dS} = \frac{q}{\epsilon_0} = 0$ (∴ charge inside the shell is zero.) ∴ $E \cdot dS = 0$, But $dS \neq 0$								
	∴ $E = 0$	1 + 1	5						

OR

(a) Derivation for energy stored	2
Derivation for energy density	1
(b) Required Proof	2

(a)

$$dU = dW = \int_0^q V dq$$

1/2

$$U = \int_0^q \frac{q}{C} dq$$

1/2

$$= \frac{1}{C} \left[\frac{q^2}{2} \right]_0^q$$

1/2

$$U = \frac{1}{C} \frac{q^2}{2} \text{ or } \frac{1}{2} CV^2$$

1/2

Energy Density $U = \frac{\text{Energy}}{\text{Volume}} = \frac{1}{2} \frac{CV^2}{A.d}$

1/2

$$U = \frac{\frac{1}{2} CV^2}{A.d}$$

But $C = \frac{\epsilon_0 A}{d}$ and $V = Ed$

$$\therefore U = \frac{1}{2} \epsilon_0 E^2$$

1/2

(b) Energy before connecting

$$U = \frac{1}{2} C_1 V_1^2$$

1/2

After connecting

$$\text{Common potential} = \frac{q_1 + q_2}{c_1 + c_2} = \frac{c_1 v_1}{c_1 + c_2}$$

1/2

$$\text{Energy Stored } U' = \frac{1}{2} (c_1 + c_2) \frac{c_1^2 v_1^2}{(c_1 + c_2)^2}$$

$$U' = \frac{1}{2} \frac{c_1^2 v_1^2}{(c_1 + c_2)}$$

1/2

$$= \frac{1}{2} \frac{c_1}{(c_1 + c_2)} U$$

$$\therefore U' < U$$

1/2

5

Set1, Q25
Set 2, Q26
Set 3, Q24

Labelled diagram	1
Principle and working	1/2 + 1
Function of radial magnetic field and soft iron core	1/2 + 1/2
Current sensitivity	1/2
Voltage sensitivity	1/2
Explanation	1/2



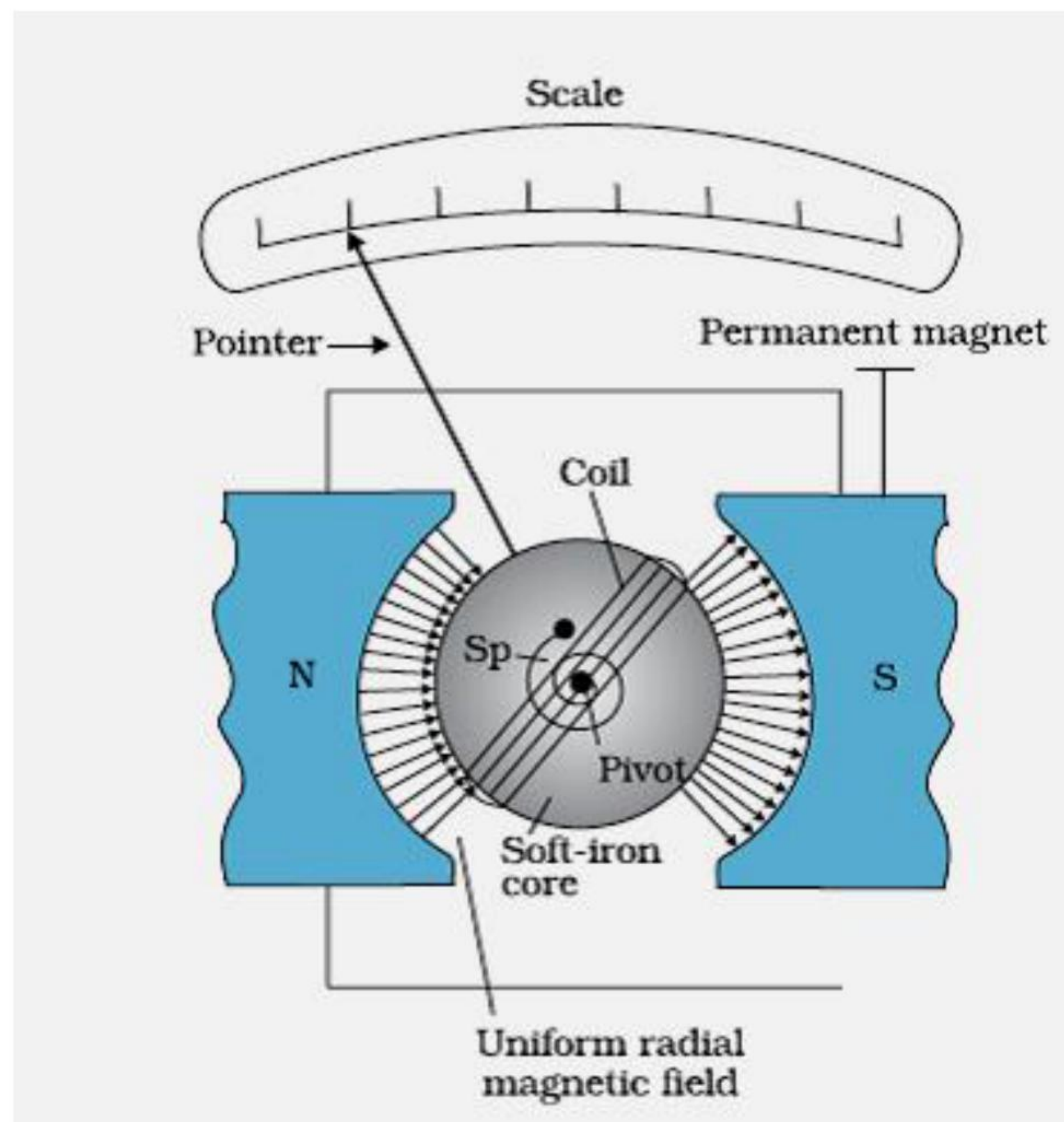

1

Principle : “Whenever a current carrying coil is placed in magnetic field, it experiences a deflecting torque.”

1/2

Working: When current is passed through a coil , free to rotate in a magnetic field , a deflecting torque ($=NiAB\sin\theta$) act on it. The coil starts to rotate . The rotation of coil is opposed, by spring S_p by providing a restoring torque ($=K\phi$). When the two torque becomes equal , coil comes to rest.

1/2

$$\therefore NiAB = K\phi$$

$$i = \frac{C\phi}{NAB} , \text{ Hence } i \propto \phi$$

1/2

Functions of (1) **Radial field** ; It keeps magnetic field lines normal to the area vector of the coil

1/2

(2) **Soft iron core**; It increases the strength of magnetic field.

1/2

Current sensitivity = deflection per unit current / $\left(\frac{\phi}{i} = \frac{NAB}{K}\right)$

1/2

Voltage sensitivity : deflection per unit voltage / $\left(\frac{\phi}{V} = \frac{NAB}{KR}\right)$

1/2

If $N \rightarrow 2N$, then by increasing number of turns, current sensitivity increases but voltage sensitivity remains same because resistance increases proportionally.

1/2

OR

(a) Expression for vector form of Biot-Savart law	1
Expression for magnetic field due to loop	3
(b) Biot-Savart law and Ampere’s Circuital law	1

5



(a) Biot-Savart law in vector form

$$\vec{dB} = \frac{\mu_0}{4\pi} I \left(\frac{d\vec{l} \times \vec{r}}{r^3} \right)$$

1

Magnetic field on the axis of a circular current loop

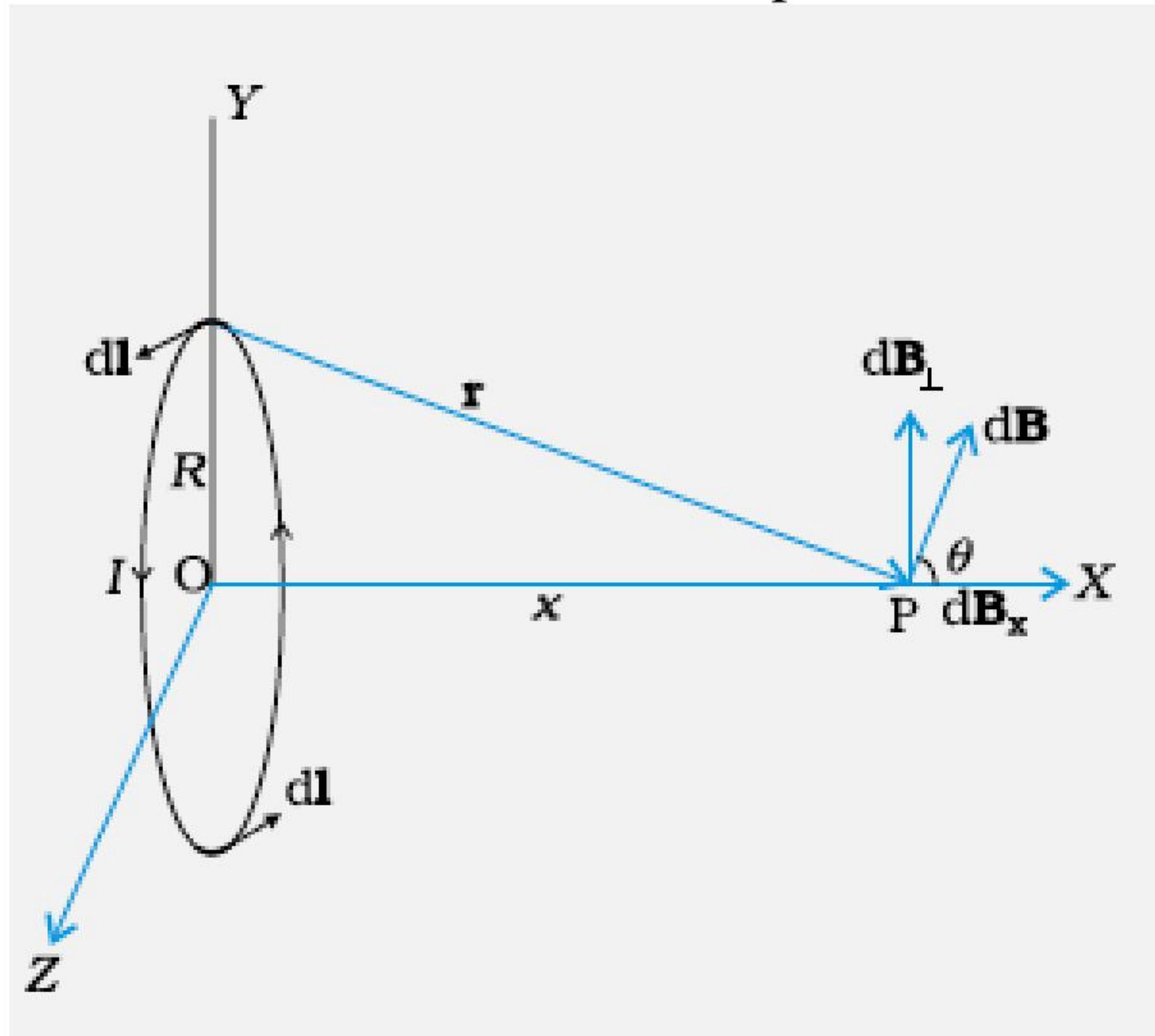

1/2

The net magnetic field is along the x-axis only.

Net contribution along X-axis

$$B = \int dB \cos\theta$$

1/2

$$\therefore dB = \frac{\mu_0 I |d\vec{l} \times \vec{r}|}{4\pi r^3}$$

$$\therefore r^2 = x^2 + R^2$$

$$\therefore dB = \frac{\mu_0 I dl}{4\pi (x^2 + R^2)}$$

1/2

$$\therefore B = \int \frac{\mu_0 I dl}{4\pi (x^2 + R^2)} \cdot \cos\theta$$

1/2

$$\therefore \cos\theta = \frac{R}{(x^2 + R^2)^{1/2}}$$

$$\therefore B = \int \frac{\mu_0 R I dl}{4\pi (x^2 + R^2)^{3/2}}$$

$$B = \frac{\mu_0 IR}{4\pi (x^2 + R^2)^{3/2}} \int dl$$

1/2

$$\therefore \int dl = 2\pi R$$

$$\therefore B = \frac{\mu_0 I R^2}{2 (x^2 + R^2)^{3/2}}$$

1/2



	<p>(b) Biot-Savart law can be expressed as Ampere's circuital law by considering the surface to be made up a large number of loops. The sum of the tangential components of the magnetic field multiplied by the length of all such elements, gives the result</p> $\oint \vec{B} \cdot d\vec{l} = \mu_0 I$ <p>Alternatively , Ampere Circuital law and Biot-Savart law , both relate the magnetic field and the current , and both express the same physical consequences of a steady current.</p>	1	5																
Set1, Q26 Set 2,Q24 Set 3,Q25	<table border="1" data-bbox="302 808 1512 932"> <tr> <td>(a) Expression for the Amplitude and the conditions</td> <td>3</td> </tr> <tr> <td>(b) Effect on Interference fringes</td> <td>1 +1</td> </tr> </table> <p>(a) The resultant displacement will be</p> $\vec{y} = \vec{y}_1 + \vec{y}_2$ $= a[\cos \omega t + \cos(\omega t + \phi)]$ $= 2a \cos \frac{\phi}{2} \cos \left(\omega t + \frac{\phi}{2} \right)$ <p>The amplitude of the resultant displacement is $A = 2a \cos \frac{\phi}{2}$</p> <p>$\therefore$ Intensity $A^2 = 4a^2 \cos^2 \frac{\phi}{2}$</p> <p>If $\phi = 0, \pm 2\pi, \pm 4\pi, \dots$ the intensity will be maximum. i.e $\phi = 2n\pi$ $= n\lambda$ where $n = 1, 2, 3 \dots$ Hence interference will be constructive.</p> <p>If $\phi = \pm\pi, \pm 3\pi, \pm 5\pi, \dots$, the intensity will be zero, i.e $\phi = (2n + 1)\pi$ $= (2n + 1) \frac{\lambda}{2}$ where $n=1, 2, 3 \dots$ Hence interference will be destructive.</p> <p>(b)(i) Pattern will become less and less sharp. (ii) At the centre there will be white fringe followed by red colour fringes on either side.</p> <p style="text-align: center;">OR</p> <table border="1" data-bbox="342 2191 1512 2517"> <tr> <td>(a) Diagram</td> <td>1</td> </tr> <tr> <td>Mathematical Proof</td> <td>1 1/2</td> </tr> <tr> <td>Graph for δ</td> <td>1</td> </tr> <tr> <td>Conditions</td> <td>1/2</td> </tr> <tr> <td>(b) Relation to μ</td> <td>1/2</td> </tr> <tr> <td>Value of μ</td> <td>1/2</td> </tr> </table>	(a) Expression for the Amplitude and the conditions	3	(b) Effect on Interference fringes	1 +1	(a) Diagram	1	Mathematical Proof	1 1/2	Graph for δ	1	Conditions	1/2	(b) Relation to μ	1/2	Value of μ	1/2	1/2 1/2 1/2 1/2 1/2 1 1	5
(a) Expression for the Amplitude and the conditions	3																		
(b) Effect on Interference fringes	1 +1																		
(a) Diagram	1																		
Mathematical Proof	1 1/2																		
Graph for δ	1																		
Conditions	1/2																		
(b) Relation to μ	1/2																		
Value of μ	1/2																		



(a)

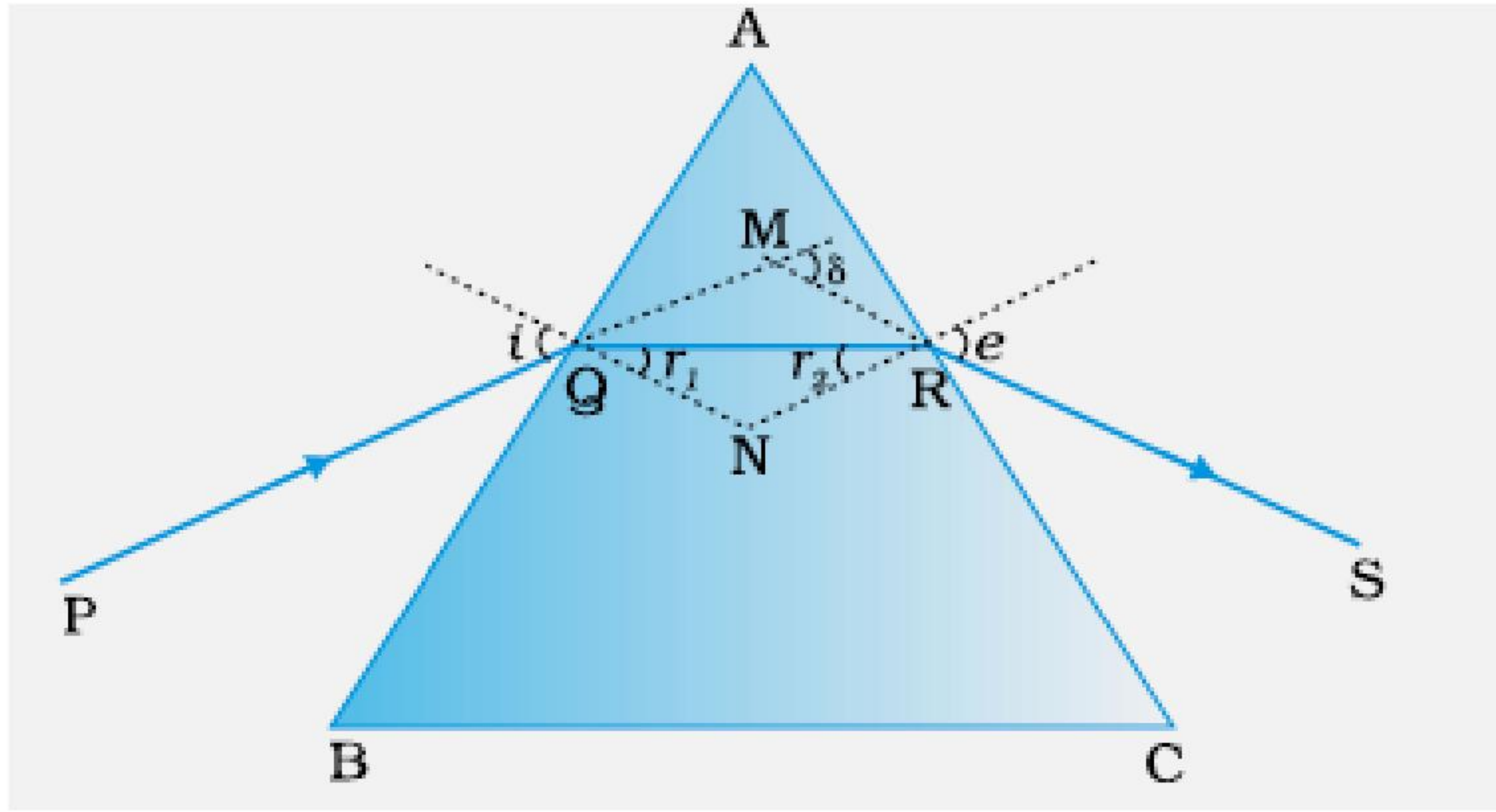

In the quadrilateral AQNR at Q and R , two of the angles are right angles.

Therefore , the sum of the other angles of the quadrilateral is 180°

$$\angle A + \angle QNR = 180^\circ$$

From the triangle QNR ,

$$r_1 + r_2 + \angle QNR = 180^\circ$$

Comparing these two equations

$$r_1 + r_2 = A$$

The total deviation δ is the sum of the deviations at the two faces

$$\delta = (i - r_1) + (e - r_2)$$

$$\text{i.e. } \delta = i + e - (r_1 + r_2)$$

$$\delta = i + e - A$$

$$\delta + A = i + e$$

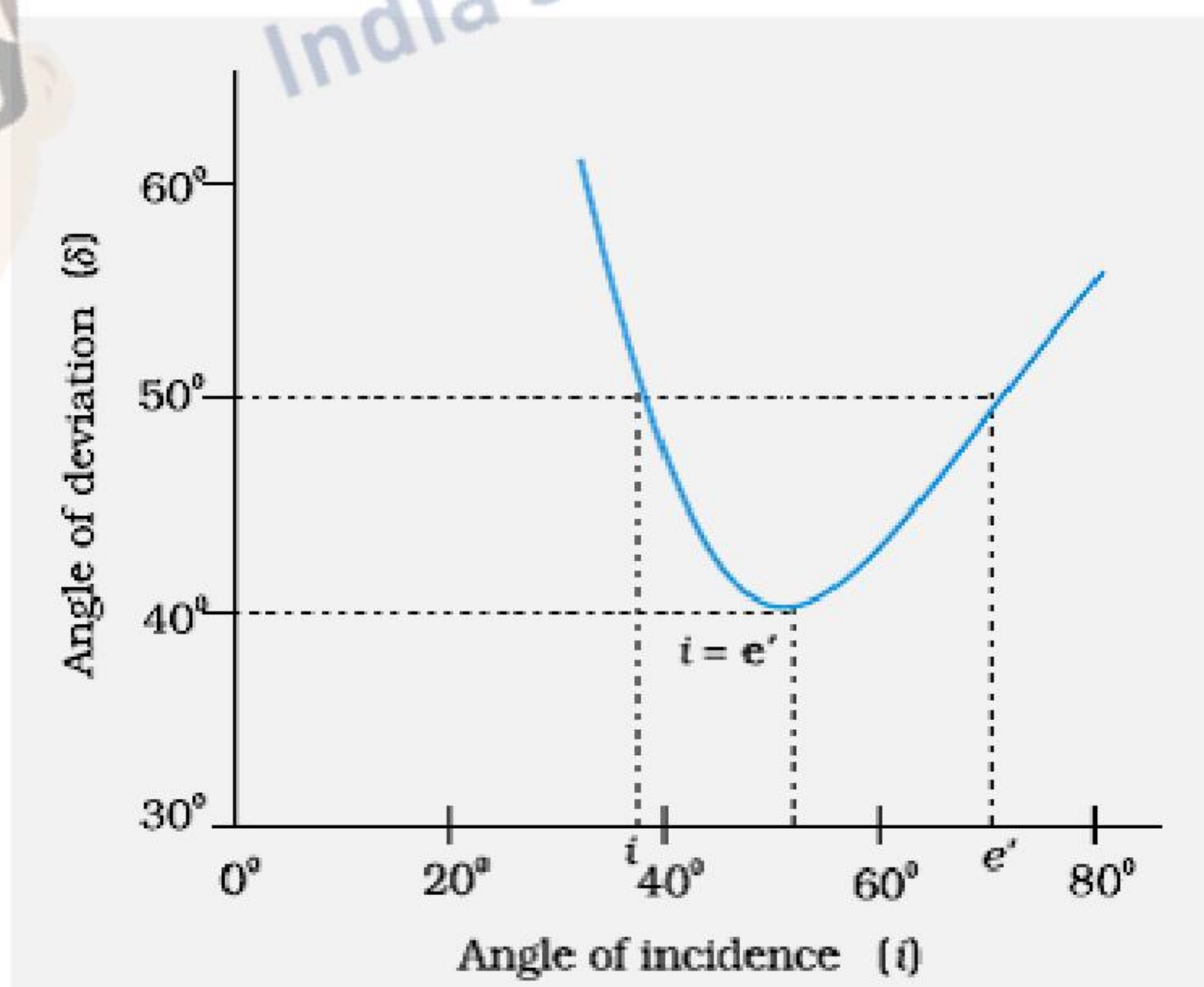

δ will be minimum for $i = e$

(b)

$$\mu = \frac{\sin\left(\frac{A + \delta_m}{2}\right)}{\sin\frac{A}{2}} = \frac{\sin A}{\sin\frac{A}{2}} = 2 \cos\frac{A}{2}$$

If $A = 60^\circ$

$$\mu = 2 \cos 30 = \sqrt{3}$$

1

1/2

1/2

1/2

1

1/2

1/2

1/2

5

