



Practice, Learn and Achieve  
Your Goal with Prepp

# IBPS RRB Exam

Mains Answer Key

Simplifying  
Government Exams

 SSC CHSL	 IAS EXAM	 RRB NTPC	 NTSE	 CDS
 SSC CGL	 CBSE UGC NET	 IBPS PO	 NDA	
 SBI PO	 IBPS CLERK	 AFCAT	 SSC JE	 CTET
 CSIR UGC NET	 CAPF	 IBPS RRB		

[www.prepp.in](http://www.prepp.in)

## Solutions

1. Ans. C.

Rising India wrestlers Bajrang Punia and Ritu Phogat have won gold medals in Men's 65kg and Women's 48kg Freestyle categories respectively at the Senior National Wrestling Championship in New Delhi.

2. Ans. D.

The Headquarter of World Bank located in Washington D.C., US.

3. Ans. C.

The UNESCO headquarters is located in Paris.

4. Ans. D.

Mahatma Gandhi National Rural Employment Guarantee Act guarantees employment for 100 days annually.

National Rural Employment Guarantee Act 2005 was later renamed as the "Mahatma Gandhi National Rural Employment Guarantee Act" (MGNREGA).

5. Ans. D.

Repo rate is the rate at which RBI lends to its clients generally against government securities

6. Ans. B.

Exercise Yudh Abhyas - 2017, a joint military exercise between Indian and US armies was conducted at the Joint Base Lewis McChord, Washington, USA.

7. Ans. E.

India's first biofuel-powered flight that aims to reduce costs of air travel by replacing the costly aviation turbine fuel was successfully tested by SpiceJet. SpiceJet used its Bombardier Q400 aircraft for this flight. SpiceJet is the only airline in India to explore aerial operations powered by BioJet fuel and intends to undertake operations using a blend of 75% of aviation turbine fuel (ATF) and 25% of BioJet fuel, which has the potential of reducing carbon footprint by 15%.

8. Ans. A.

Currently Ajay Tyagi is a chairman of SEBI.

9. Ans. C.

Government of India has notified FAME India Scheme [Faster Adoption and Manufacturing of (Hybrid &) Electric Vehicles in India] for implementation with effect from 1st April 2015, with the objective to support hybrid/electric vehicles market development and Manufacturing eco-system. The scheme has 4 focus areas i.e. Technology development, Demand Creation, Pilot Projects and Charging Infrastructure.

10. Ans. A.

As per RBI website, the current **SLR is 19.50%**.

Statutory liquidity ratio (**SLR**) is the Indian government term for reserve requirement that the commercial banks in India require maintaining in the form of gold, the government approved securities before providing credit to the customers.

11. Ans. D.

**Copenhagen** is the **capital** and **Krone** is the currency of **Denmark**.

**Note:-**Denmark is a Scandinavian country in Europe.

12. Ans. D.

Free and compulsory education for children between the age of **6 to 14 years**.

13. Ans. C.

The 2019 G20 Tokyo summit will be the fourteenth meeting of Group of Twenty (G20). It will be held in 2019 in the city of Tokyo. It will be the first-ever G20 summit to be hosted in Japan.

14. Ans. D.

The Central government proposed the amalgamation of State-owned Bank of Baroda, Dena Bank and Vijaya Bank to create India's third largest bank as part of reforms in the public sector banking segment. The amalgamated bank would be the third largest bank in India and will be strong competitive lender with economies of scale.

15. Ans. E.

Former cricketer & Pakistan Tehreek-e-Insaf (PTI) Chief Imran Khan has taken oath as the 22nd Prime Minister of the country.

Khan bagged 176 votes opponent and Chief of Pakistan Muslim League-Nawaz (PML-N) Shehbaz Sharif managed to secure 96 votes.

16. Ans. D.

The Brabourne Stadium is a cricket ground in Mumbai, Maharashtra. The ground is owned by the Cricket Club of India (CCI).

The North Stand of the Brabourne housed the Board of Control for Cricket in India (BCCI) headquarters and the 1983 Cricket World Cup trophy until 2006 when both were moved to the newly built Cricket Centre at the nearby Wankhede Stadium.

17. Ans. A.

ASHA must primarily be a woman resident of the village married/ widowed/ divorced, preferably in the age group of 25 to 45 years.

18. Ans. C.

- Biplab Kumar Dev is the chief minister of Tripura.
- The capital of Tripura is Agartala.
- Biplab Kumar Dev has been the state president of the Bharatiya Janata Party (BJP) in Tripura since 7 January 2016.

19. Ans. B.

Justin Trudeau is the prime minister of Canada. The capital of Canada is Ottawa and currency of Canada is Canadian Dollar.

20. Ans. A.

Padma Bhushan awards are given on Republic Day. Republic Day is celebrated on 26<sup>th</sup> January every year.

21. Ans. A.

Dr. Harshvardhan Singh is the current minister of Ministry of Science & Technology.

22. Ans. D.

GDP prediction of India by Central Statistics Office in first quarter of 2018 is 8.2%.

23. Ans. B.

World Red cross day is observed on 8<sup>th</sup> May.

24. Ans. B.

The Estimates Committee of Parliament, led by Murli Manohar Joshi, has asked the PMO to depose and provide details on what action the government initiated on a list of large corporate houses, which had amassed a large amount of NPAs

25. Ans. E.

Rana Kapoor is the CEO of Yes Bank. The headquarters of Yes Bank is Mumbai.

26. Ans. A.

Recently, a football team members and coach were trapped in a cave. They are from Thailand.

27. Ans. E.

Master batsman Virat Kohli smacked his **25th century** and his sixth in Australia, joining the elite company of boyhood hero Sachin Tendulkar.

Playing in his 75th Test, the Indian run-machine did it in style with a classic straight drive off Mitchell Starc to reach triple figures on day three of the second Test in Perth.

28. Ans. E.

DRDO stands for Defence Research and Development Organisation. The Defence Research and Development Organisation is an agency, that is charged with the military's research and development, headquartered in New Delhi, India.

29. Ans. C.

drone of 250gm does not need any permission from Director General of Civil Aviation.

30. Ans. D.

Backheel term is used in the sport of Football.

31. Ans. A.

Sachin Tendulkar has turned down Doctorate Degree from Jadavpur University. Jadavpur University is in West Bengal.

32. Ans. A.

Initially, Gaganyaan was planned to be launched by the Indian Space Research Organisation by 2022. In the latest reports, ISRO has planned to have the first unmanned (without astronaut) mission of Gaganyaan, in December 2020 and the second unmanned mission in July 2021. Finally, the first Gaganyaan mission with astronauts will be executed in **December 2021**.

33. Ans. A.

The North American Free Trade Agreement (NAFTA) is an agreement signed by USA, Canada, Mexico.

34. Ans. E.

The headquarters of National Institute of Petroleum are in Dehradun, Uttarakhand.

35. Ans. B.

India's food grain production is forecast to grow to a record in the crop year ending June 2018 after a normal monsoon and wider planting in winter. Food grain output is expected to increase to 280 million tonnes.

36. Ans. A.

In BSBDA account, as directed by the individual banks, four times a user can withdraw money from this account.

37. Ans. D.

Mahe, the smallest district is in Puducherry.

38. Ans. E.

99.3% of the junked Rs. 500 and Rs 1,000 notes have returned to the banking system as per a report published by Reserve Bank of India.

39. Ans. C.

Menaka Gandhi, minister of Women and Child Development has announced new cyber cell for women facing online abuse.

40. Ans. C.

Arun Jaitley is not the member of Monetary Policy Committee, a committee of Reserve Bank of India.

41. Ans. D.

Let the principal given by A to B = 100P

R = 10%

T = 1 year

Amount which B has to pay =  $100P(1 + r/100) =$

$100P(1 + 10/100) = 110P$

Now, B gives it to a bank

Principal = 100P

R = 20%

But it is compounded half yearly.

$\therefore R_1 = (20/2)\% = 10\%$

$T_1 = 2T = 2*1 = 2$

Amount which bank has to refund to B =  $100P(1 + 10/100)^2 = 121P$

Bank distribute the Principal amount to C and D in ratio = 2:3

Share of C =  $(100P/5)*2 = 40P$

Share of D =  $(100P/5)*3 = 60P$

R = 25%

T = 1 year

Amount to be returned by C =  $40P(1 + 25/100) = 50P$

Amount to be returned by D =  $60P(1 + 25/100) = 75P$

Amount received by bank = 125P

Profit of bank = Amount received by bank - Amount which bank has to refund to B =  $125P - 121P = 4P$

Profit of bank = Rs 2640 [Given]

$4P = 2640$

$P = 660$

Amount invested by A =  $100P = 100*660 = \text{Rs } 66000$

42. Ans. B.

Event A1 it rains on party day

Event A2 it does not rain on party day

Event B the man predicted rain

Therefore  $P(A1) = 5/365 = 0.014$  and

$P(A2) = 360/365 = 0.9863$

$P(B/A1) = 0.9$  [forecasts of 90% rain]

$P(B/A2) = 0.1$  [when it not rain]

Now, using formula

$P(A1/B) = P(A1)P(B/A1) / [$

$P(A1)P(B/A1) + P(A2)P(B/A2)]$

$= 0.014*0.9 / (0.014*0.9 + 0.986*0.1)$

$= 0.111$

43. Ans. C.

As the size of the room is  $40*48$ , the square tile maximum size will be of 8 ft \* 8 ft which is the common factor of 40 and 48.

Minimum number of square tiles required are  $40 * 48 / 64 = 30$

44. Ans. E.

Let the age of Ameer and Sharukh be A years and S years respectively

$A = 5/3 S$

$S = 3(S - (A - S))$

$S = 6S - 3A$

$\Rightarrow 5S = 3A$

If we observe above equations both are dependant equations. Hence more than one answer can be obtained. So the answer is Data insufficient.

45. Ans. A.

Let the price of the shirt be 1000

Rajni availed two successive discounts of 20% and 5%

So, the net price of the shirt

$= 1000 * \frac{80}{100} * \frac{95}{100} = 760$

Total discount = 240

Let the price of the shirt be 1000

Reshma availed two successive discounts of 15% and 10%

So, the net price of the shirt

$$= 1000 * \frac{85}{100} * \frac{90}{100} = 765$$

Total discount = 235

Let the price of the shirt be 1000

Sunil availed two successive discounts of 12% and 13%.

So, the net price of the shirt

$$= 1000 * \frac{88}{100} * \frac{87}{100} = 765.6$$

Total discount = 234.4

Therefore, Rajni gets the maximum possible discount

So option (a) is the correct answer.

46. Ans. B.

Total Mails received by Mayank = 1450

Mails read in Inbox = 72% of 1450 = 1044

Spam Mails read by Mayank = 20% of 50% of 1450 = 145

Useful mails read = 1044-145 = 899

47. Ans. E.

Number of mails read in spam = 20% of 22% of 1600 = 70.4

Ratio of read mails = 4:5

Therefore total read mails = (9/4)\* 70.4 = 158.4

Required Percentage = 158.4\*100/1600 = 9.9%

48. Ans. A.

Mails Read by Different persons

Ujjwal = 1044

Mayank = 1300

Pritam = 585

Shashank = 864

Total read mails = 3793

Total Mails Received = 1450+1600+1300+1080 = 5430

Required Percentage = 3793\*100/5430 = 69.80 = 70%

49. Ans. D.

Mails read by Shashank = 80% of 1080

Spam mails received by Mayank = 50% of 1450

Required Ratio = 80\*108 : 50 \* 145

864:725

50. Ans. C.

Read mails in spam = 80% of 20% of 1080

Read Mails = 80% of 1080

Required percentage = 20 %

51. Ans. B.

Compound interest (two years) = Simple interest (two years) + Rs. 1050

Simple interest (two years) = 8000

So, compound interest earned at the end of two years = 8000 + 1050 = 9050

So option (b) is the correct answer.

52. Ans. C.

Let the amount of crude in spherical tank be 'a'

Amount of crude in cylindrical tank = a + 600

Thus, (a + 600 - 400) = 2(a - 400)

⇒ a + 200 = 2a - 800

⇒ a = 1000 m<sup>3</sup>

Amount of crude in cylindrical tank = 1000 + 600 = 1600 m<sup>3</sup>

53. Ans. E.

As he increases his weight by 25 %.

We do not even need the original weight here to evaluate the required correction actually.

Let his original weight is 100Kg and as he increases his weight by 25 % then his weight becomes 125

If we come back to the original weight then we have to do 20% reduction in the stated weight.

**Alternative:**

The required percentage decrease is given as =  $[x/(100+x)]*100$

where, x is the percentage increase which is 25, so  
Required Correction = (25/125)\*100 = 20% decrease

54. Ans. A.

Part of the tank filled by pipe A in 1 minute = 1/30

Part of the tank filled by pipe B in 1 minute = 1/20

Part of the tank filled by pipe C in 1 minute = 1/10

Here we have to find the proportion of the solution R.

Pipe C discharges chemical solution R.

Part of the tank filled by pipe C in 3 minutes

= 3\*1/10 = 3/10 = 3\*1/10 = 3/10

Part of the tank filled by pipe A,B,C together in 1 minute

= 1/30 + 1/20 + 1/10 = 11/60

Part of the tank filled by pipe A,B,C together in 3 minutes

= 3\*11/60 = 11/20 = 3\*11/60 = 11/20

Required proportion = (3\*20) / (10\*11) = 6 / 11

55. Ans. E.

Amount of acid in 20 ml of first solution = 20a  
Amount of acid in 30 ml of second solution = 30b  
Amount of acid in the resulting solution =  $9.2 \times 50 = 460$

$$2x+3y=46$$

Amount of acid in 70 ml of first solution = 70a

Amount of acid in 140 ml of second solution = 140b

Amount of acid in the resulting solution =  $210 \times 9 \frac{1}{3}$

$$a+2b=28$$

$$b = 10, a=8$$

$$a+b=18$$

So option (e) is the correct answer.

56. Ans. A.

Difference in Cost of Travel =  $130 \times 18 - 78 \times 26 = 2340 - 2028 = \text{Rs } 312$

57. Ans. E.

Distance travelled by train =  $2600(1 - (1/26) - (1/52)) = 2450 \text{ Km}$

Time taken in March to August cycle =  $2450/260$

Cost in March to August cycle =  $2450 \times 130/260$

Time taken in September to February cycle =  $2450/195$

Cost in September to February cycle =  $2450 \times 78/195$

Required Ratio = 5:4

58. Ans. A.

Cost in March to August cycle =  $130 \times 18 = 2340$

Cost in September to February cycle =  $78 \times 26 = 2028$

Cost of Autorickshaw =  $(1/52) \times 2600 \times 10 = \text{Rs } 500$

Cost of Car =  $(1/26) \times 2600 \times 26 = \text{Rs } 2600$

Average Cost =  $(12 \times 2600 + 12 \times 500 + 6 \times 2340 + 6 \times 2028) / 12 = 5284$

59. Ans. D.

Cost of Autorickshaw =  $(1/52) \times 2600 \times 10 = \text{Rs } 500$

Cost of Car =  $(1/26) \times 2600 \times 26 = \text{Rs } 2600$

Required percentage =  $500 \times 100 / 2600 = 19 \frac{3}{13} \%$

60. Ans. A.

Distance travelled By autorickshaw =  $(1/52) \times 2600$

Distance travelled By autorickshaw =  $(1/26) \times 2600$

Required Ratio = 1:2

61. Ans. A.

Sumith : Sonu =  $6750 : (9000 - 6750) = 3:1$

ATQ

Let Sonu invested X Rs. And Sumith invested X + 10000 Rs

$$[(10000+X) \times 8] / 12X = 3/1$$

$$8 \times (10000+X) = 36X$$

$$X = 20000/7$$

$$X = 2857.14 \text{ Rs.}$$

$$\text{Sumith capital} = 2857.14 + 10000 = 12857.14$$

62. Ans. C.

let the present ages of A and B be a years and b years respectively. Given  $a > b$

Thus  $a/b > 1$  So,

$$\frac{a}{b} > \frac{a+7}{b+7} > \frac{a+12}{b+12}$$

$$\text{But } \left(\frac{a+7}{b+7}\right)^2 > ((a+12)/(b+12))^2$$

$$= \left(\frac{a+7}{b+7}\right) > \frac{a+12}{b+12} = x > y$$

63. Ans. B.

Sum of eight numbers =  $25 \times 8 = 200$

Sum of first two numbers =  $\frac{39}{2} \times 2 = 39$

Sum of first three numbers =  $\frac{70}{3} \times 3 = 70$

Let, the sixth number be x

So, sum of sixth, seventh and eighth number =  $200 - (39+70) = 200 - 109 = 91$

$$= x + x + 5 + x + 8 = 91$$

$$= x = 26$$

Therefore, seventh number =  $26 + 5 = 31$

So option (b) is the correct answer.

64. Ans. B.

As we know,

Profit =  $16 \frac{2}{3} \%$

Cost price of cycle =  $(1400/7) \times 6 = \text{Rs } 1200$

Now, let's assume that the discount available is D%.

Since the cashier applied the discount twice accidentally, the selling price after 2 successive discounts = Marked price  $\times (1 - (\text{Discount } \%) / 100) \times (1 - (\text{Discount } \%) / 100)$

$$\Rightarrow \text{MP} \times (1 - D/100)^2 = 1400$$

$$\Rightarrow 1400/5600 = (1 - D/100)^2$$

$$\Rightarrow 1 - D/100 = 1/2$$

$$\Rightarrow D = 50$$

Hence, the available discount is 50%.

Had the cashier applied the discount correctly,

Selling Price =  $(5600/100) \times 50 = \text{Rs } 2800$

Actual profit =  $2800 - 1200 = \text{Rs } 1600$   
Profit percentage =  $(1600/1200) \times 100 = 133$   
(1/3)%

65. Ans. C.

Let  $x$  and  $y$  be the speed of boat and stream respectively

Given,  
 $135/(x+y) = 9$   
 $x+y=15$

Also,  
 $30/(x+y) = (1.10 \times 4)/(x-y)$   
 $15(x-y) = 22(x+y)$   
 $x+y=15$

So,  
 $15(x-y) = 22 \times 15$   
 $x-y = 22$

On solving, we get,  $y = 3.5 \text{ km/hr}$   
So option (c) is the correct answer.

66. Ans. D.

The total amount spent by Ravi in both 2013 and 2016 together =  $(1860 \times 1120) + (1240 \times 2320) = >$   
 $2083200 + 2876800 = \text{Rs. } 4960000$

67. Ans. B.

The price per square feet in the year 2011 and 2014 together =  $> 1360 + 2240 = 3600$  The price per square feet in the year 2012 and 2015 together =  $> 1520 + 1840 = 3360$  Required % =  $(3600/3360) \times 100 = 107\%$

68. Ans. A.

The amount spent by Rahul in the year 2013 =  $>$   
 $(3280 \times 1120)$   
The amount spent by Raghu in the year 2014 =  $>$   
 $(1820 \times 2240)$   
Required ratio =  $[3280 \times 1120] : [1820 \times 2240] = 82 : 91$

69. Ans. C.

The amount spent by Rajesh to buy a land in the year 2012 = 38 lakhs  
The square feet of land bought by Rajesh in the year 2012 =  $> 3800000/1520 = 2500$  Square feet

70. Ans. A.

The average price per square feet of land in all the given years except 2015 =  $> (1360 + 1520 + 1120 + 2240 + 2320)/5$   
 $= > 8560/5 = 1712$

71. Ans. C.

Let the number of tennis balls be  $x$  and the number of rubber balls be  $y$ .

Therefore,  $x+y = 48$ (given)... (i)

From statement 1:

$x/y = 3/1$

Therefore,  $x = 3y$

Therefore, substituting in (i), we get,

$3y + y = 48$

$\Rightarrow y = 12$  and  $x = 3y = 3 \times 12 = 36$ .

The minimum number of balls required to be drawn from the box in order to ensure that a tennis ball is drawn will be  $y + 1$  i.e.,  $12 + 1 = 13$

Since, only after all rubber balls are drawn, one can be certain that the next ball drawn is a tennis ball) Hence, statement 1 alone is sufficient to answer the question.

From statement 2:  $y = 12$

Therefore,  $x = 48 - 12 = 36$

Hence, statement 2 alone is also sufficient to answer the question.

Hence, option is 3.

72. Ans. B.

Let A and B meet after time  $t$ .

$t = 100/S_A + S_B$ .....equation (i)

Statement 1 alone is not sufficient to answer the question.

Statement 2:

Let, Amar's speed be  $1.5x$  and Deepak's speed be  $x$ .

Therefore time taken will be same  $t$  to reach the point of their meeting

$D/1.5x = (100-D)/x$

$D = 60 \text{ km}$

So ques can be answered using only statement 2

73. Ans. D.

Statement 1 alone is not sufficient to answer this question as we don't know the speed of the jeep.

Statement 2 alone is not sufficient as we don't know the distance between A and B.

Combining statement 1 & 2;

$= 15t/60 + (t-20)45 = 10000$

We can solve this equation for  $t$ .

Hence, option is 4.

74. Ans. E.

Statement 1 and statement 2 are not sufficient to answer the question as the initial state of cistern is not known i.e., whether the cistern is empty or not.

Hence, the option is 5.

75. Ans. C.

Statement 1: the line joining the centres will divide the common chord into two equal parts and make an angle of measure  $90^\circ$  with it. Now, using Pythagoras theorem, we can get the desired distance.

Statement 2: using the formula,

Length of the direct common tangent

$$= [(Distance\ between\ centres) - (Difference\ of\ radius)^2]^{1/2}$$

We can get the desired distance.

Hence, option is 3.

76. Ans. B.

$$\text{Required ratio} = 13\% \text{ of } 7000 : 23\% \text{ of } 4500 = 182 : 207$$

77. Ans. A.

Number of dry Apples sold on Saturday = (Number of Apples - Wet apples sold on Saturday)

$$= 1190 - 720 = 470$$

Number of dry Apples sold on Sunday = 160% of 470 = 752

$$\text{Required total Apples} = 470 + 752 = 1222$$

78. Ans. A.

$$\text{Required difference} = 14\% \text{ of } 7000 - 17\% \text{ of } 4500 = 215$$

79. Ans. D.

Dry Apples sold on Monday = Number of Apples - wet Apples sold on Monday

$$= 1120 - 765 = 355$$

Dry Apples sold on Saturday = Number of Apples - wet Apples sold on Saturday

$$= 1190 - 720 = 470$$

$$\text{Required ratio} = 355 : 470 = 71 : 94$$

80. Ans. C.

Number of Apples- dry sold on Monday = 1120 - 765 = 355

Number of Apples- dry sold on Tuesday = 910 - 765 = 145

Total Number of dry apples = 7000 - 4500 = 2500

$$\text{Required Percentage} = [(355 + 145) / 2500] * 100$$

$$= 20\%$$

81. Ans. D.

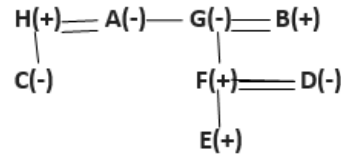

82. Ans. D.

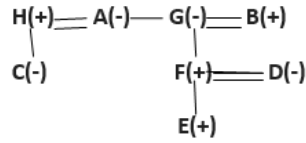

83. Ans. B.

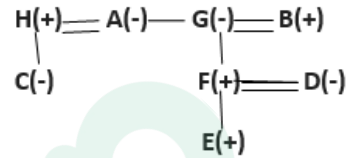

84. Ans. C.

The distance between point M and point S is  $6 + 6 = 12m$

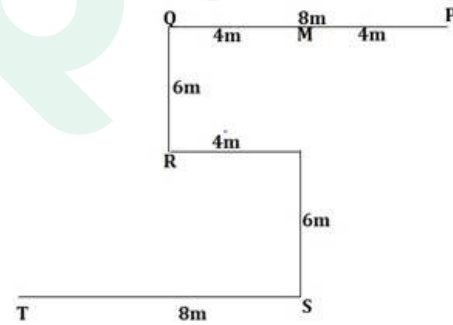

85. Ans. A.

Point Q is in north-east of point T.

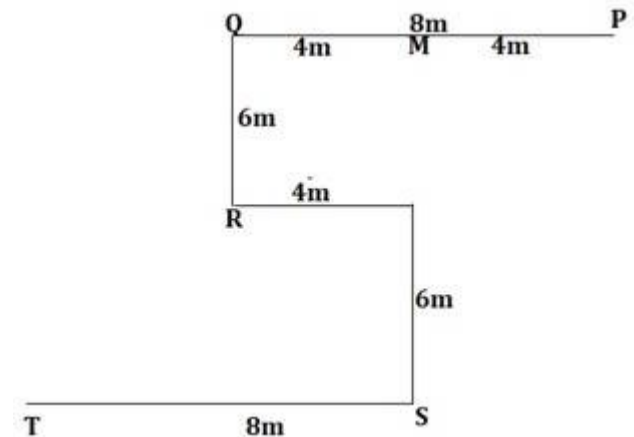



86. Ans. B.

Point R is in north-west of point S.

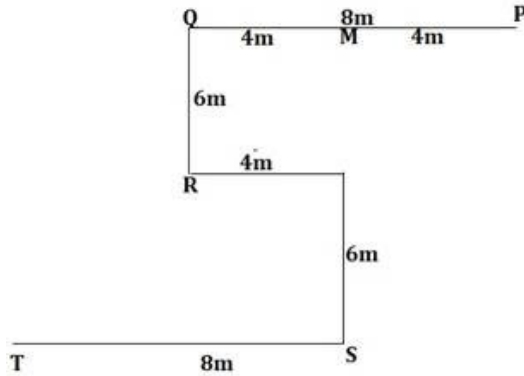

87. Ans. A.

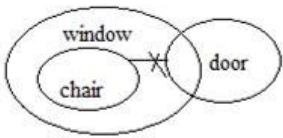

Hence, option (a) is the answer.

88. Ans. D.

From I.  $A > P > M$ , R, K

From II.  $A, P > M > K, R$

Thus, I and II both are not sufficient to answer the question.

89. Ans. B.

**From statement I:**

P stands second to the right of R. R faces the centre. Q stands second to the left of P. Q is an immediate neighbor of both U and T. U and P face opposite directions (i.e. if U faces the centre then P faces outside and vice-versa.) Only two people stand between P and T.

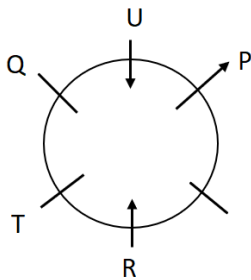

Here we can say that T is 2<sup>nd</sup> to the right of U. Hence data in statement I alone is sufficient to answer the question.

**From II:**

Only two people stand between R and U. P stands to the immediate left of U. P faces outside. R is an immediate neighbor of T.

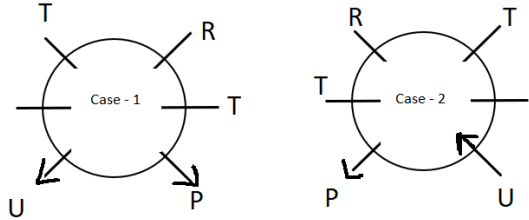

Data in statement II alone is not sufficient to answer.

90. Ans. E.

From I and II it is clear that "rest" is coded as "tu".

91. Ans. B.

From II it is clear that Rahul left on 23rd of the month as the first prime number after 19 is 23.

92. Ans. C.

I. Two person lives between A and C. A lives one of the floor above C who lives immediately above D.

From this statement, we have

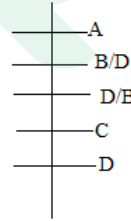

II. B lives on an odd numbered floor above floor 1. So it can only be floor no. 3 or 5. But if B is on the floor no. 3 we cannot place DCE or ECD together on 3 consecutive floors as D and E are immediate neighbors of C. So, B will come only on the floor no. 5 i.e, the topmost floor.

From this statement, we have

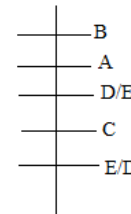

So, from either of the statements, the answer is obtained.

Hence, option (C) is the answer.

93. Ans. A.

Only conclusion I follows from the given statement. We have been told that the PRI has dominated Mexico's politics for the better part of a century, from which we can easily conclude that they've won most of the elections that have been held in Mexico in the last 100 years. Conclusion II does not follow because we do not know for certain if the PRI is going to lose in the coming elections. The statement tells us that the ruling party seems to be at a risk of defeat. Conclusion II does not follow as we do not know the reasons for assuming that the ruling party might not win the upcoming elections. Therefore, option A is the correct answer.

94. Ans. D.

At first it may seem statement I is the cause and II is effect, but the reduction in accident cannot be happening not just because of new traffic light. Kochi had old system of traffic light system, the new system is to curb road blocks. And reduction in accident can be mainly caused by well-maintained road, speed limits, strict checking not just by new traffic light system. Statement I is caused by increasing traffic block and II by any of the above mentioned reasons, so both statements are effects with independent causes.

95. Ans. D.

Both assumptions I and II are valid. The statement says that people are returning to "what is left of their homes", from which we can assume that their homes were almost destroyed. Similarly, because the families are returning to the city, we can assume that they were driven away or left when Isis took over their city. However, assumption III is not valid as we cannot assume if all of the residents had left and none of them supported Isis from the given statement. Hence, option D is the correct answer.

96. Ans. E.

None of the courses of action follow. All of them contain a lot of extraneous information and are impractical solutions. Therefore, option E is the correct answer.

97. Ans. C.

Both the inferences can be correctly inferred. The given statement says that due to climate changes sea levels are rising and because of this, more than three hundred thousand homes will get flooded every two weeks in the next 30 years. I is an obvious deduction - people who live near the

coastlines will be financially and emotionally affected. And II can also be clearly inferred - to combat this situation, greenhouse gas emissions that are the main cause of rising sea levels, need to be curtailed with immediate effect. Therefore, option C is the correct answer.

98. Ans. B.

Friends: P, Q, R, S, T and U

City: Agra, Kanpur, Mysore, Mumbai, Bhopal and Ranchi.

- 1) Only two people sit between P and the one who live in Kanpur.
- 2) Only one person sits between P and the one who live in Mysore.
- 3) R sits immediate left of the one who live in Mysore.
- 4) Two people sit between R and the one who live in Mumbai.
- 5) U sits immediate left of the one who live in Mumbai.

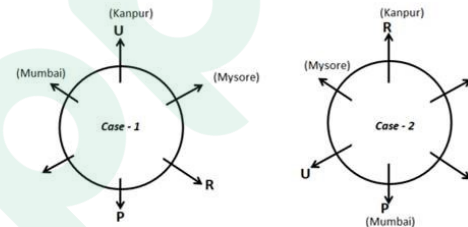

- 6) S lives in Ranchi and sits immediate right of Q.
- 7) T and the one who live in Bhopal are not an immediate neighbor's.

(Now only leftover is Agra. Hence person who live in Agra sit in leftover place)

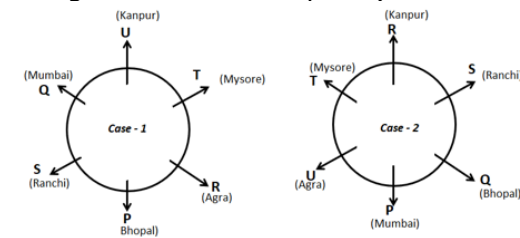

- 8) Q doesn't live in Bhopal.

(Here case - 2 will get eliminated)

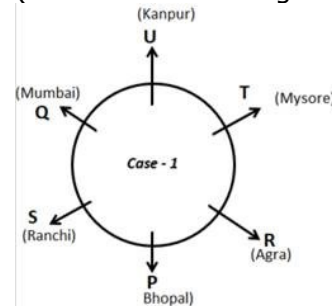

Above arrangement will be final arrangement.  
 "Q" lives in Mumbai who is immediate left of S.

99. Ans. C.

Friends: P, Q, R, S, T and U

City: Agra, Kanpur, Mysore, Mumbai, Bhopal and Ranchi.

- 1) Only two people sit between P and the one who live in Kanpur.
- 2) Only one person sits between P and the one who live in Mysore.
- 3) R sits immediate left of the one who live in Mysore.
- 4) Two people sit between R and the one who live in Mumbai.
- 5) U sits immediate left of the one who live in Mumbai.

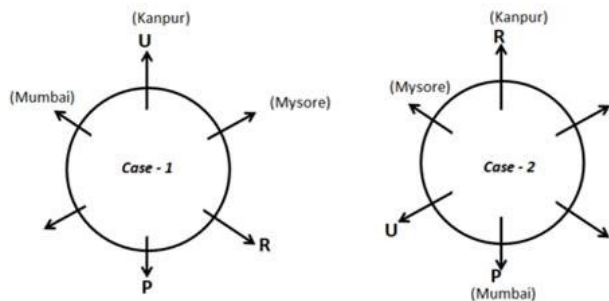

- 6) S lives in Ranchi and sits immediate right of Q.
  - 7) T and the one who live in Bhopal are not an immediate neighbor's.
- (Now only leftover is Agra. Hence person who live in Agra sit in leftover place)

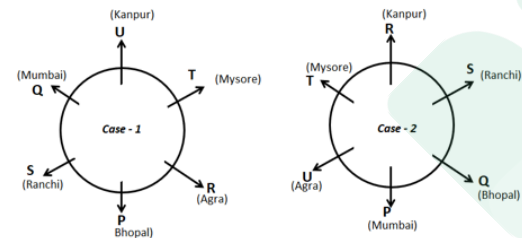

- 8) Q doesn't live in Bhopal.
- (Here case - 2 will get eliminated)

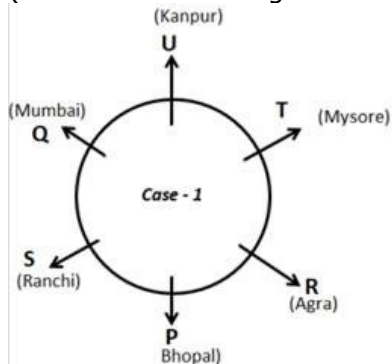

Above arrangement will be final arrangement.  
 P lives in Bhopal.  
 P is 3<sup>rd</sup> to left or 3<sup>rd</sup> to right of U.

100. Ans. A.

Friends: P, Q, R, S, T and U

City: Agra, Kanpur, Mysore, Mumbai, Bhopal and Ranchi.

- 1) Only two people sit between P and the one who live in Kanpur.
- 2) Only one person sits between P and the one who live in Mysore.
- 3) R sits immediate left of the one who live in Mysore.
- 4) Two people sit between R and the one who live in Mumbai.
- 5) U sits immediate left of the one who live in Mumbai.

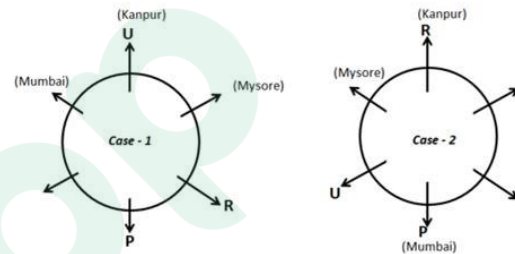

- 6) S lives in Ranchi and sits immediate right of Q.
  - 7) T and the one who live in Bhopal are not an immediate neighbor's.
- (Now only leftover is Agra. Hence person who live in Agra sit in leftover place)

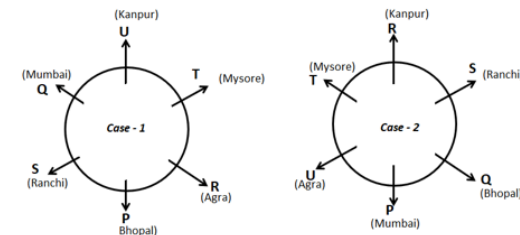

- 8) Q doesn't live in Bhopal.
- (Here case - 2 will get eliminated)

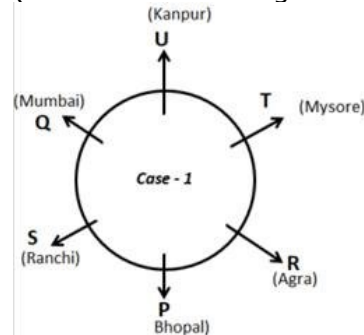

Above arrangement will be final arrangement.

Person between U and who lives in Ranchi,  
 When counted from right of U  $\Rightarrow$  1  
 When counted from left of U  $\Rightarrow$  3  
 Hence, "when counted right of U there are only one person sits between U and person who lives in Ranchi.

101. Ans. B.

Friends: P, Q, R, S, T and U

City: Agra, Kanpur, Mysore, Mumbai, Bhopal and Ranchi.

- 1) Only two people sit between P and the one who live in Kanpur.
- 2) Only one person sits between P and the one who live in Mysore.
- 3) R sits immediate left of the one who live in Mysore.
- 4) Two people sit between R and the one who live in Mumbai.
- 5) U sits immediate left of the one who live in Mumbai.

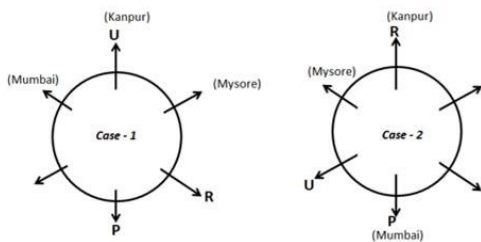

- 6) S lives in Ranchi and sits immediate right of Q.
- 7) T and the one who live in Bhopal are not an immediate neighbor's.

(Now only leftover is Agra. Hence person who live in Agra sit in leftover place)

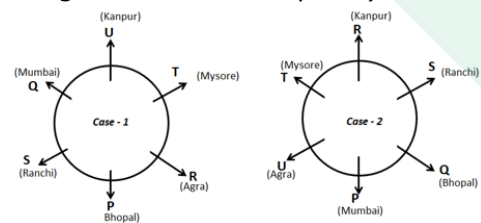

8) Q doesn't live in Bhopal.

(Here case - 2 will get eliminated)

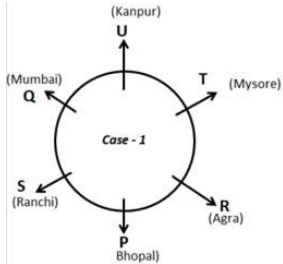

Above arrangement will be final arrangement.

- A) T and P are immediate neighbours  $\Rightarrow$  False
  - B) The one who live in Bhopal sits second to the right of the one who live in Mumbai.  $\Rightarrow$  True
  - C) R sits second to the right of the one who live in Kanpur.  $\Rightarrow$  False
  - D) Q and R doesn't sits opposite to each other.  $\Rightarrow$  False
- Hence, only B) is true.

102. Ans. C.

Friends: P, Q, R, S, T and U

City: Agra, Kanpur, Mysore, Mumbai, Bhopal and Ranchi.

- 1) Only two people sit between P and the one who live in Kanpur.
- 2) Only one person sits between P and the one who live in Mysore.
- 3) R sits immediate left of the one who live in Mysore.
- 4) Two people sit between R and the one who live in Mumbai.
- 5) U sits immediate left of the one who live in Mumbai.

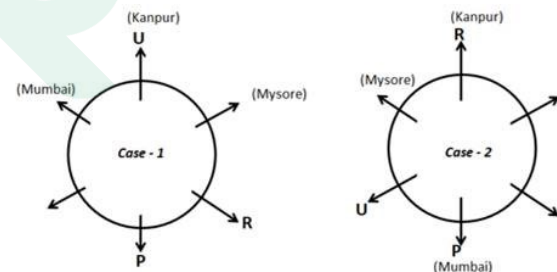

- 6) S lives in Ranchi and sits immediate right of Q.
- 7) T and the one who live in Bhopal are not an immediate neighbor's.

(Now only leftover is Agra. Hence person who live in Agra sit in leftover place)

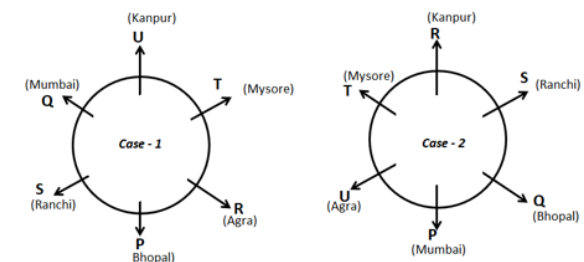

8) Q doesn't live in Bhopal.

(Here case - 2 will get eliminated)

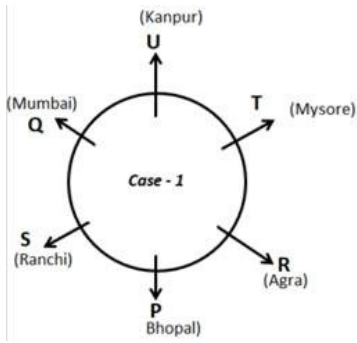

Above arrangement will be final arrangement.  
The person who lives in Agra sits immediate right of P.

103. Ans. B.

Bottles: A, B, C, M, N and P.

1) M contains less amount of milk than B and A.

$\Rightarrow B, A > M$

2) P and C contain less amount of milk than M but more than N.

$\Rightarrow B, A > M > P, C > N$

3) C does not contain the second least amount of milk.

4) A doesn't have the maximum amount of milk.

$\Rightarrow B > A > M > C > P > N$

5) Bottle which has third maximum milk has 16 liters.

6) The one which contains second least amount of milk has 9 liters.

$\Rightarrow B > A > M (16 \text{ litres}) > C > P (9 \text{ litres}) > N$

If  $B + P = 27$  liters,

$B = 27 - P = 27 - 9 = 18$  liters.

If  $A + M = 34$  liters.

$A = 34 - M = 34 - 16 = 18$  liters

Now, total amount of milk in B and A is  $= 18 + 18 = 36$  liters.

104. Ans. D.

Bottles: A, B, C, M, N and P.

1) M contains less amount of milk than B and A.

$\Rightarrow B, A > M$

2) P and C contain less amount of milk than M but more than N.

$\Rightarrow B, A > M > P, C > N$

3) C does not contain the second least amount of milk.

4) A doesn't have the maximum amount of milk.

$\Rightarrow B > A > M > C > P > N$

5) Bottle which has third maximum milk has 16 liters.

6) The one which contains second least amount of milk has 9 liters.

$\Rightarrow B > A > M (16 \text{ litres}) > C > P (9 \text{ litres}) > N$   
Hence, B contain maximum amount of milk.

105. Ans. C.

Bottles: A, B, C, M, N and P.

1) M contains less amount of milk than B and A.

$\Rightarrow B, A > M$

2) P and C contain less amount of milk than M but more than N.

$\Rightarrow B, A > M > P, C > N$

3) C does not contain the second least amount of milk.

4) A doesn't have the maximum amount of milk.

$\Rightarrow B > A > M > C > P > N$

5) Bottle which has third maximum milk has 16 liters.

6) The one which contains second least amount of milk has 9 liters.

$\Rightarrow B > A > M (16 \text{ litres}) > C > P (9 \text{ litres}) > N$

If B If the bottle B contains 80 liters of milk then

Ration of quantity of M and B  $= M/B = 16/80 =$

$1/5 \Rightarrow 1 : 5$

106. Ans. C.

Bottles: A, B, C, M, N and P.

1) M contains less amount of milk than B and A.

$\Rightarrow B, A > M$

2) P and C contain less amount of milk than M but more than N.

$\Rightarrow B, A > M > P, C > N$

3) C does not contain the second least amount of milk.

4) A doesn't have the maximum amount of milk.

$\Rightarrow B > A > M > C > P > N$

5) Bottle which has third maximum milk has 16 liters.

6) The one which contains second least amount of milk has 9 liters.

$\Rightarrow B > A > M (16 \text{ litres}) > C > P (9 \text{ litres}) > N$

As milk in bottle C is between P and M.

So possible amount in C is  $10 \leq C \leq 15$

Hence, 13 liters is the correct option.

107. Ans. D.

Bottles: A, B, C, M, N and P.

1) M contains less amount of milk than B and A.

$\Rightarrow B, A > M$

2) P and C contain less amount of milk than M but more than N.

$\Rightarrow B, A > M > P, C > N$

3) C does not contain the second least amount of milk.

4) A doesn't have the maximum amount of milk.

⇒ B > A > M > C > P > N

5) Bottle which has third maximum milk has 16 liters.

6) The one which contains second least amount of milk has 9 liters.

⇒ B > A > M (16 litres) > C > P (9 litres) > N

Therefore, M contain 16 liters of milk.

108. Ans. C.

People: A, B, C, X, Y and Z

City: Mumbai, Lucknow, Manali, Delhi, Indore and Raipur

Designation: General Manager (GM), Deputy General Manager (DGM), Chief Manager (CM), Manager (MG), Officer (OR) and Clerk (CK)  
Lower most post is Clerk and Higher most is GM (as given in order.)

1) Only two people are Junior to the one who likes Indore.

2) The one who like Mumbai is senior to the one who like Indore.

3) Only two people hold a position between A and the one who like Mumbai.

	Case - 1		Case - 2		Case - 3	
Designation	City	Name	City	Name	City	Name
Gm					Mumbai	
DGM			Mumbai			
CM	Mumbai					
MG	Indore		Indore		Indore	A
OR				A		
CK		A				

4) As many people senior to the one who likes Manali is as many Junior to A.

(Therefore, here case - 2 gets eliminated)

5) The one who like Raipur is immediate senior of the one who like Manali.

(Here case - 1 will gets eliminated)

6) No one hold a position between C and the one who like Manali.

(Now only Lucknow person left that will hold leftover designation)

	Case - 3	
Designation	City	Name
Gm	Mumbai	
DGM	Raipur	C
CM	Manali	
MG	Indore	A
OR		
CK		

7) Two people hold a position between the one who like Manali and the one who like Delhi.

8) B is senior to Z and Y but not the senior most people.

9) Z doesn't like Lucknow.

Designation	City	Name
GM	Mumbai	X
DGM	Raipur	C
CM	Manali	B
MG	Indore	A
OR	Lucknow	Y
CK	Delhi	Z

Above combination will be final combination.

Hence, Z likes Delhi.

109. Ans. D.

People: A, B, C, X, Y and Z

City: Mumbai, Lucknow, Manali, Delhi, Indore and Raipur

Designation: General Manager (GM), Deputy General Manager (DGM), Chief Manager (CM), Manager (MG), Officer (OR) and Clerk (CK)  
Lower most post is Clerk and Higher most is GM (as given in order.)

1) Only two people are Junior to the one who likes Indore.

2) The one who like Mumbai is senior to the one who like Indore.

3) Only two people hold a position between A and the one who like Mumbai.

	Case - 1		Case - 2		Case - 3	
Designation	City	Name	City	Name	City	Name
Gm					Mumbai	
DGM			Mumbai			
CM	Mumbai					
MG	Indore		Indore		Indore	A
OR				A		
CK		A				

4) As many people senior to the one who likes Manali is as many Junior to A.

(Therefore, here case - 2 gets eliminated)

5) The one who like Raipur is immediate senior of the one who like Manali.

(Here case - 1 will gets eliminated)

6) No one hold a position between C and the one who like Manali.

(Now only Lucknow person left that will hold leftover designation)

	Case - 3	
Designation	City	Name
Gm	Mumbai	
DGM	Raipur	C
CM	Manali	
MG	Indore	A
OR		
CK		

- 7) Two people hold a position between the one who like Manali and the one who like Delhi.  
 8) B is senior to Z and Y but not the senior most people.  
 9) Z doesn't like Lucknow.

Designation	City	Name
GM	Mumbai	X
DGM	Raipur	C
CM	Manali	B
MG	Indore	A
OR	Lucknow	Y
CK	Delhi	Z

Above combination will be final combination.

- A) C, Manali ⇒ False (as C – Raipur is correct)  
 C) Y, CK ⇒ False (as Y – OR is correct)  
 D) A, MG ⇒ True  
 E) X, Raipur ⇒ False (as X – Mumbai)  
 Hence, "A, MG" is correct.

110. Ans. B.

People: A, B, C, X, Y and Z

City: Mumbai, Lucknow, Manali, Delhi, Indore and Raipur

Designation: General Manager (GM), Deputy General Manager (DGM), Chief Manager (CM), Manager (MG), Officer (OR) and Clerk (CK)  
 Lower most post is Clerk and Higher most is GM (as given in order.)

- 1) Only two people are Junior to the one who likes Indore.  
 2) The one who like Mumbai is senior to the one who like Indore.  
 3) Only two people hold a position between A and the one who like Mumbai.

	Case – 1		Case – 2		Case – 3	
Designation	City	Name	City	Name	City	Name
Gm					Mumbai	
DGM			Mumbai			
CM	Mumbai					
MG	Indore		Indore		Indore	A
OR				A		
CK		A				

- 4) As many people senior to the one who likes Manali is as many Junior to A.  
 (Therefore, here case – 2 gets eliminated)  
 5) The one who like Raipur is immediate senior of the one who like Manali.  
 (Here case – 1 will gets eliminated)  
 6) No one hold a position between C and the one who like Manali.  
 (Now only Lucknow person left that will hold leftover designation)

	Case – 3	
Designation	City	Name
Gm	Mumbai	
DGM	Raipur	C
CM	Manali	
MG	Indore	A
OR		
CK		

- 7) Two people hold a position between the one who like Manali and the one who like Delhi.  
 8) B is senior to Z and Y but not the senior most people.  
 9) Z doesn't like Lucknow.

Designation	City	Name
GM	Mumbai	X
DGM	Raipur	C
CM	Manali	B
MG	Indore	A
OR	Lucknow	Y
CK	Delhi	Z

Above combination will be final combination.

There are 2 people who hold position between B and who like Delhi)

111. Ans. E.

People: A, B, C, X, Y and Z

City: Mumbai, Lucknow, Manali, Delhi, Indore and Raipur

Designation: General Manager (GM), Deputy General Manager (DGM), Chief Manager (CM), Manager (MG), Officer (OR) and Clerk (CK)  
 Lower most post is Clerk and Higher most is GM (as given in order.)

- 1) Only two people are Junior to the one who likes Indore.  
 2) The one who like Mumbai is senior to the one who like Indore.  
 3) Only two people hold a position between A and the one who like Mumbai.

	Case – 1		Case – 2		Case – 3	
Designation	City	Name	City	Name	City	Name
Gm					Mumbai	
DGM			Mumbai			
CM	Mumbai					
MG	Indore		Indore		Indore	A
OR				A		
CK		A				

- 4) As many people senior to the one who likes Manali is as many Junior to A.  
 (Therefore, here case – 2 gets eliminated)  
 5) The one who like Raipur is immediate senior of the one who like Manali.

(Here case – 1 will get eliminated)

6) No one holds a position between C and the one who likes Manali.

(Now only Lucknow person left that will hold leftover designation)

Case – 3		
Designation	City	Name
Gm	Mumbai	
DGM	Raipur	C
CM	Manali	
MG	Indore	A
OR		
CK		

7) Two people hold a position between the one who likes Manali and the one who likes Delhi.

8) B is senior to Z and Y but not the senior most people.

9) Z doesn't like Lucknow.

Designation	City	Name
GM	Mumbai	X
DGM	Raipur	C
CM	Manali	B
MG	Indore	A
OR	Lucknow	Y
CK	Delhi	Z

Above combination will be final combination.

X is related to Raipur

X is just above position to Raipur.

C is related to Manali

C is just above position to Manali.

Similarly,

A is just above position to Lucknow.

Hence, A is related to Lucknow.

112. Ans. C.

People: A, B, C, X, Y and Z

City: Mumbai, Lucknow, Manali, Delhi, Indore and Raipur

Designation: General Manager (GM), Deputy General Manager (DGM), Chief Manager (CM), Manager (MG), Officer (OR) and Clerk (CK)

Lower most post is Clerk and Higher most is GM (as given in order.)

1) Only two people are Junior to the one who likes Indore.

2) The one who likes Mumbai is senior to the one who likes Indore.

3) Only two people hold a position between A and the one who likes Mumbai.

Designation	Case – 1		Case – 2		Case – 3	
	City	Name	City	Name	City	Name
Gm					Mumbai	
DGM			Mumbai			
CM	Mumbai					
MG	Indore		Indore		Indore	A
OR				A		
CK		A				

4) As many people senior to the one who likes Manali is as many Junior to A.

(Therefore, here case – 2 gets eliminated)

5) The one who likes Raipur is immediate senior of the one who likes Manali.

(Here case – 1 will get eliminated)

6) No one holds a position between C and the one who likes Manali.

(Now only Lucknow person left that will hold leftover designation)

Case – 3		
Designation	City	Name
Gm	Mumbai	
DGM	Raipur	C
CM	Manali	
MG	Indore	A
OR		
CK		

7) Two people hold a position between the one who likes Manali and the one who likes Delhi.

8) B is senior to Z and Y but not the senior most people.

9) Z doesn't like Lucknow.

Designation	City	Name
GM	Mumbai	X
DGM	Raipur	C
CM	Manali	B
MG	Indore	A
OR	Lucknow	Y
CK	Delhi	Z

Above combination will be final combination.  
C who likes Raipur holds the position of DGM.

113. Ans. C.

Laptops: U, V, W, X, Y, Z, A, B, C, D and E

1) Two laptops were bought between Z and Y.

2) E was bought just before Y.

3) There were four laptops bought between Z and A.

4) A was bought before Z.

Case – 1	...			A	E	Y		Z	....
Case – 2	...	A				Z	E	Y	...



5) Three laptops were bought between E and X.

Case - 1	...	X		A	E	Y		Z	....
Case - 2	...	A		X		Z	E	Y	...

6) As many Laptops were bought between D and X is as same as between E and D.

(Here case - 2 gets eliminated)

7) U was bought just before C.

8) Only two laptops were bought after C.

Case - 1	X	D	A	E	Y	U	C	Z	
----------	---	---	---	---	---	---	---	---	--

9) Two laptops were bought between U and V.

10) B was bought before W.

11) W was not bought after E.

Case - 1	B	X	W	D	A	E	Y	U	C	Z	V
----------	---	---	---	---	---	---	---	---	---	---	---

Above table shows final arrangement.

B is the first laptop which first brought.

114. Ans. A.

Laptops: U, V, W, X, Y, Z, A, B, C, D and E

1) Two laptops were bought between Z and Y.

2) E was bought just before Y.

3) There were four laptops bought between Z and A.

4) A was bought before Z.

Case - 1	...			A	E	Y		Z	....
Case - 2	...	A				Z	E	Y	...

5) Three laptops were bought between E and X.

Case - 1	...	X		A	E	Y		Z	....
Case - 2	...	A		X		Z	E	Y	...

6) As many Laptops were bought between D and X is as same as between E and D.

(Here case - 2 gets eliminated)

7) U was bought just before C.

8) Only two laptops were bought after C.

Case - 1	X	D	A	E	Y	U	C	Z	
----------	---	---	---	---	---	---	---	---	--

9) Two laptops were bought between U and V.

10) B was bought before W.

11) W was not bought after E.

Case - 1	B	X	W	D	A	E	Y	U	C	Z	V
----------	---	---	---	---	---	---	---	---	---	---	---

Above table shows final arrangement.

Hence, 3 laptops were bought between C and A.

115. Ans. C.

Laptops: U, V, W, X, Y, Z, A, B, C, D and E

1) Two laptops were bought between Z and Y.

2) E was bought just before Y.

3) There were four laptops bought between Z and A.

4) A was bought before Z.

Case - 1	...			A	E	Y		Z	....
Case - 2	...	A				Z	E	Y	...

5) Three laptops were bought between E and X.

Case - 1	...	X		A	E	Y		Z	....
Case - 2	...	A		X		Z	E	Y	...

6) As many Laptops were bought between D and X is as same as between E and D.

(Here case - 2 gets eliminated)

7) U was bought just before C.

8) Only two laptops were bought after C.

Case - 1	X	D	A	E	Y	U	C	Z	
----------	---	---	---	---	---	---	---	---	--

9) Two laptops were bought between U and V.

10) B was bought before W.

11) W was not bought after E.

Case - 1	B	X	W	D	A	E	Y	U	C	Z	V
----------	---	---	---	---	---	---	---	---	---	---	---

Above table shows final arrangement.

A) D was bought just after A.  $\Rightarrow$  False (as D bought just before A)

B) U was bought at Last.  $\Rightarrow$  False (as U was bought 4<sup>th</sup> last)

C) Y was bought just before U  $\Rightarrow$  True

D) Three laptops were bought between W and A  $\Rightarrow$  False (as only one laptop bought between W and A)

Hence, "Y was bought just before U" is the only correct statement.

116. Ans. D.

Laptops: U, V, W, X, Y, Z, A, B, C, D and E

1) Two laptops were bought between Z and Y.

2) E was bought just before Y.

3) There were four laptops bought between Z and A.

4) A was bought before Z.

Case - 1	...			A	E	Y		Z	....
Case - 2	...	A				Z	E	Y	...

5) Three laptops were bought between E and X.

Case - 1	...	X		A	E	Y		Z	....
Case - 2	...	A		X		Z	E	Y	...

6) As many Laptops were bought between D and X

is as same as between E and D.

(Here case - 2 gets eliminated)

7) U was bought just before C.

8) Only two laptops were bought after C.

Case - 1	X	D	A	E	Y	U	C	Z
----------	---	---	---	---	---	---	---	---

9) Two laptops were bought between U and V.

10) B was bought before W.

11) W was not bought after E.

Case - 1	B	X	W	D	A	E	Y	U	C	Z	V
----------	---	---	---	---	---	---	---	---	---	---	---

Above table shows final arrangement.

A) BX ⇒ B bought just before X.

B) UC ⇒ U bought just before C.

C) XW ⇒ X bought just before W.

D) EA ⇒ E bought just after A.

E) ZV ⇒ Z bought just before V.

Hence, EA is odd one among the given alternatives.

117. Ans. E.

Laptops: U, V, W, X, Y, Z, A, B, C, D and E

1) Two laptops were bought between Z and Y.

2) E was bought just before Y.

3) There were four laptops bought between Z and A.

4) A was bought before Z.

Case - 1	...			A	E	Y		Z	...
Case - 2	...	A				Z	E	Y	...

5) Three laptops were bought between E and X.

Case - 1	...	X		A	E	Y		Z	...
Case - 2	...	A		X		Z	E	Y	...

6) As many Laptops were bought between D and X

is as same as between E and D.

(Here case - 2 gets eliminated)

7) U was bought just before C.

8) Only two laptops were bought after C.

Case - 1	X	D	A	E	Y	U	C	Z
----------	---	---	---	---	---	---	---	---

9) Two laptops were bought between U and V.

10) B was bought before W.

11) W was not bought after E.

Case - 1	B	X	W	D	A	E	Y	U	C	Z	V
----------	---	---	---	---	---	---	---	---	---	---	---

Above table shows final arrangement.

Number of laptops bought before A → 4

Number of laptops bought after Y → 4

Hence, "Y" is the correct answer.

118. Ans. E.

Logic:

If number is even ⇒ divided by 2

If number is odd ⇒ Subtract 1 from number, then divide by 2

If 12 25 54 is written as 6 12 27

$$12/2 = 6$$

$$(25 - 1)/2 = 12$$

$$54/2 = 27$$

71 91 67 is written as 35 45 33

$$(71 - 1)/2 = 35$$

$$(91 - 1)/2 = 45$$

$$(67 - 1)/2 = 33$$

Similarly,

36 14 39 13 is written as

$$36/2 = 18$$

$$14/2 = 07$$

$$(39 - 1)/2 = 19$$

$$(13 - 1)/2 = 06$$

Hence, "36 14 39 13" is written as "18 07 19 06"

119. Ans. D.

Given Word: A D V E N T U R O U S

1st letter = V; 5th letter = N; 7th letter = U; 8th

letter = O

Letters given: V N U O

No meaningful word can be formed by using the letters V N U O.

Hence, answer is X.

120. Ans. A.

The pattern is as follows:

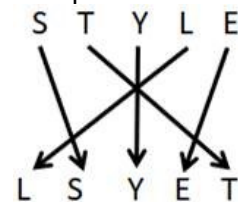

And,

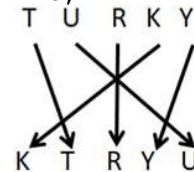

Similarly,

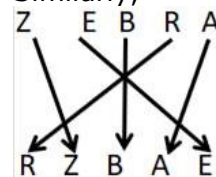

Hence, RZBAE is the correct answer.

121. Ans. C.

When Facebook labeled Winthrop's story, which was published by Newport Buzz, as "fake news", a bunch of conservative groups took it upon themselves to share this news as much as possible because they felt that Facebook was trying to silence the blog. Hence, the traffic to the piece skyrocketed and the story gained popularity.

122. Ans. B.

In the 2nd paragraph of the passage it is mentioned that the news article by Newport Buzz which says that a large number of Irish people were brought to the US as slaves was false. Hence, B is the correct answer.

123. Ans. E.

To stop the misinformation, Facebook has partnered with third party fact-checkers and fake news articles are being publicly flagged now. Also, since Facebook was accused of helping Trump win the elections, a feature has been introduced that allows users to report fake news, which is then reviewed by Facebook's fact-checkers. Hence, E is the correct answer.

124. Ans. D.

Facebook's initiatives to stop misinformation are failing because the articles that are debunked by fact-checkers often remain on the site without the "disputed" tag for a long time, until they go viral. They are tagged after the damage has been done. The extent of effectiveness of the tag is yet to be determined. Hence, D is the correct answer.

125. Ans. C.

Facebook faced criticism that it may have helped Donald Trump win the elections. Hence, C is the correct answer.

126. Ans. D.

Both ABC News and Associated Press are the fact-checking partners of Facebook. It can be inferred from the following statement of the passage, 'Articles formally debunked by Facebook's fact-checking partners - including the Associated Press, Snopes, ABC News and PolitiFact - frequently remain on the site without the "disputed" tag warning users about the content.'

127. Ans. A.

The above passage talks about Facebook's failure in stopping misinformation. While a number of

strategies have been introduced by Facebook to stop misinformation, none of them have worked very effectively so far. Hence, A is the correct answer.

128. Ans. B.

The author analyses the issue by discussing the views of experts and fake news authors. Hence, B is the correct answer.

129. Ans. B.

Propaganda means information which is biased or false. The opposite of false news is truth. Hence, B is the correct answer.

130. Ans. A.

Concerted means collaborative.

Hence, option A 'Collective' is the correct answer.

131. Ans. A.

As it is clearly stated in the 1st paragraph of the passage that there is scope in the revamping of expenditure in the farm sector to boost productivity and production. Revamping means restructuring and therefore the best option is A. All other options are simply not related to the context.

132. Ans. D.

The first sentence states what the soaring commodity prices and farm incomes have done to a particular sector. If a sector sells products at elevated costs and if it profits hugely through farm incomes, the sector will undoubtedly benefit. So, the blank requires a word which is positive in nature. "Weakened", "diminished", and "cripple" are words that convey a negative meaning and their usage would make the sentence meaningless. "Ease off" plays the similar role and hence it can be discarded. Thus, the correct word is strengthened and option D is the correct answer.

133. Ans. A.

"Aggravating" means making any issue or situation worse that can turn out to be out of control.

"Exasperate" means infuriate.

"Escalating" means increase rapidly or accelerate.

It has already been established that soaring farm incomes have strengthened the sector. This means that the farm incomes have increased or escalated. Thus, option A is the correct answer. "Increase" would have been a suitable word had it been used as a verb.

134. Ans. E.

"Sustainability" means the ability to be maintained at a certain rate or level.

"Appetite" means a strong desire or liking for something (especially food)

"Aversion" means a strong dislike or disinclination.

It has already been stated that increased farm incomes and low interest rates have led to a recent surge in farmland values. The sentence carrying the third blank states that if this trend continues, something may happen to the higher farmland values. Clearly, higher farm value will continue to exist as they do if this trend continues. So 'sustainability' is the best fit word and option E is the correct answer.

135. Ans. B.

"Validate" means demonstrate or support the truth or value of, while "apex" means the top or highest part of something, especially one forming a point. The sentence talks about statistics that bring to light the risks that are faced by agriculture banks. So, 'highlight' is the most appropriate word to fit the blank. "Apex", "prove" and "validate" don't convey the same meaning and make the sentence entirely vague and out of context. "Points off" is an incorrect phrasal verb.

Hence, B is the correct answer.

136. Ans. C.

"Collateral" means additional but subordinate or something pledged as security for repayment of a loan, to be forfeited in the event of a default. "Pawn" means a person used by others for their own purposes. "Descended" means to make a sudden attack on someone.

Given the economic context of the passage, the usage of 'pawn' an 'descendent' will be incorrect. However, "collateral" will make a logical sense. "Core" and "authentic", when used with the noun "values", reflects on the fundamental beliefs of a person.

Hence, C is correct.

137. Ans. E.

"Constitute" means to combine to form, while "accumulate" means gather together or acquire an increasing number or quantity of. "Escalate" means make or become more intense or serious; "exacerbate" means make some situation worse, and "dwindle" means diminish gradually in size, amount, or strength. The sentence conveys the idea that the loans secured by farmland combine to

form more than twice the amount of credits for agriculture production.

Hence, option E is the correct answer.

138. Ans. A.

"Fortified" means provide with defensive works as protection against attack or secure, while "authenticated" means to prove or show (something) to be true, genuine, or valid. "Corroborate" means confirm or give support to, while "ratify" means give consent to. Since the loans secured by farmland constitute twice the amount of credit extended, the agricultural loans from these banks are saved/ protected/ fortified from risk by the farm real estate. Hence, A is correct.

139. Ans. C.

"Surging" means increase suddenly, while "diminish" means less valuable. "Curtail" means to impose a restriction on, while "retrench" means reduce costs or spending in response to economic difficulty. Throughout the passage, it has been established that farmland values are on a rise, so 'surging' is the most appropriate answer. Option C is correct.

140. Ans. D.

"Censorious" means severely critical of others, while "pedantic" means excessively concerned with minor details or rules or over-scrupulous. "Quintessential" means representing the most perfect or typical example of a quality or class and "conventional" means based on or in accordance with what is generally done or believed. The sentence reflects the tone of the paragraph, which is positive, and hence, the factors are proven to be favourable for the agriculture banks. The other options don't match the tone of the passage. Hence, option D is the correct answer.

141. Ans. B.

In economic terms, "volatility" means the liability to change rapidly and unpredictably, especially for the worse. "Dispersion" means the action or process of distributing things or people over a wide area. "Transitory" means not permanent, while "outlay" means an amount of money spent on something. The sentence states a negative effect of concentration in any economic sector and volatility is the best fit answer. Hence, B is correct.

142. Ans. D.

Abeyence is the incorrectly spelt word. It must be spelled as 'abeyance' which means 'a state of temporary disuse or suspension.' Thus option D is the correct answer.

143. Ans. A.

The incorrectly spelt word here is 'model' which means 'a person trying to imitate something.' The word 'modal' is incorrect which means 'relating to mode or form as opposed to substance.' Thus A is the correct answer.

144. Ans. B.

The incorrectly spelt word is 'abhorrence' which means 'a strong feeling of hate paired with a feeling of loathing.' The word 'deceitful' means 'cheat'. Thus option C is the correct answer.

145. Ans. E.

All the given words are correctly spelt. Hence, option E is the correct answer

146. Ans. D.

Indicium = signs, indications, or distinguishing marks.

Malaise = a general feeling of discomfort, illness, or unease whose exact cause is difficult to identify.

Gauge = an indicator

The incorrectly spelt word is awery. The correct spelling is awry which means away from the usual or expected course; amiss.

Hence, option D is the correct answer.

147. Ans. D.

The sentence has grammatical as well as structural errors.

'The bollworm pests ..... which leads to the deaths ..... is being investigated ....' doesn't make sense.

The death of farmers and laborers is a past event so 'leads' doesn't go well with that context. In the above sentence 'leads' must be replaced with 'led'.

The correct answer is option D.

148. Ans. D.

Since there is an 'are' later in the sentence and 'tourists' at the beginning it means that the sentence is plural. 'Wants' can only be used with singular nouns. It must be replaced with 'want'. Hence the correct answer is option D.

149. Ans. A.

In the first sentence, the subject "Knowledge, wisdom and understanding" is plural, so its verb should also be plural. "Plays" should be replaced with "play". Hence, option A is the correct option.

150. Ans. B.

The error in B is the incorrect use of the adverb 'simply' and needs to be replaced with the adjective 'simple' to make the sentence grammatically and contextually correct. This is because 'simply' means in a straightforward or plain manner, 'simple' means easily understood or done; presenting no difficulty. In this sentence the art is being defined as 'simple' and for defining a noun adjective is needed and not an adverb.

151. Ans. E.

All the given sentences are correct.

152. Ans. C.

Sentence 3 suggests the subject apologizing in the bar. Option i highlights the reason for the apology whereas option iii highlights the way of it. Option ii doesn't offer anything meaningful to the sentence. Hence the correct answer is option C.

153. Ans. B.

Raising funds for the flood stricken is a community service which is well justified by using option ii. The other options don't make sense in the context of the sentence. The correct answer is option B.

154. Ans. A.

Sentence 5 starts off with a disagreement among a community which is explained by option i. Option ii and iii don't make proper sense when used in the blank. Those are also grammatically incorrect when used in the sentence. The correct answer is option A.

155. Ans. A.

The given sentence projects relationship between cardiac arrest and high blood pressure which is only justified by using alternative (i) in the blank. Rest all don't make sense when used in the blank. Hence the correct answer is option A.

156. Ans. D.

Sentence 1 suggests to a managers decision in an event of player injury. Players are taken off from the pitch in case of an injury which makes options ii and iii correct. Hence the correct answer is option D.

157. Ans. A.

Following are the meanings of the words in the bold:

1. Fueled is a verb which means anything that keeps people's ideas or feelings active, or makes them stronger.

2. Jingoistic is an adjective which is characterized by extreme patriotism, especially in the form of aggressive or warlike foreign policy.

3. Buttressed is a verb which means to increase the strength of or justification for; reinforce.

4. Coerce is a verb which means to persuade an unwilling person to do something by using force or threats.

Clearly, "fuelled is placed correctly as national security climate can be instigated by social practices. 'Regiment' is a verb which means to organize according to a strict system or pattern. So, 'coerce' is also correctly used. The expression "climate was jingoistic by a discourse" sounds erroneous. Thus, 'jingoistic' is incorrect at (1). Similarly, "buttressed" is not an apt adjective for "appeals". If the places of "jingoistic" and "buttressed" are interchanged, the sentence will convey proper sense.

158. Ans. E.

Following are the meanings of the words in the bold:

1. Bastion is a noun which refers to an institution, place, or person strongly maintaining particular principles, attitudes, or activities.

2. Elite is a noun which refers to a select group that is superior in terms of ability or qualities to the rest of a group or society.

3. Oligarchic is an adjective which is related to or based on an oligarchy. An oligarchy is a small group of people who control and run a particular country or organization.

4. Supportive is an adjective which means providing encouragement or emotional help. All bold words are correctly placed and no correction is required; Though "elite" and "oligarchic" could have been interchanged without altering the meaning, we do not have an option which mentions the two together. Hence, option E is the apt answer.

159. Ans. A.

To be a product of something means the result of a particular thing. Thus, the word "product" has been correctly placed at (2) and makes logical sense. "Value" is correct at (4) as material possessions can

be valued as sources of happiness. The expression "physical name" sounds erroneous at (3), thus it needs to be replaced. Since "good name" is a correct term, "name and "possession" can be interchanged.

160. Ans. D.

"Afford" is incorrect at (1) as the singular subject "book" will take a singular verb, but "afford" is a plural verb. So we need another highlighted verb that is singular. Thus, "represents" should be used at (1) and "afford" should be placed at (3). Thus, option D is the correct answer.

161. Ans. B.

RAM is a Volatile memory whose contents are erased when the system's power is turned off or interrupted.

162. Ans. A.

Windows **ME ( Millennium Edition)** is a **graphical operating** system from **Microsoft** released to manufacturing in **June 2000** and launched in **September 2000**. It was the last **operating system** released in the **Windows 9x series**.

163. Ans. E.

In computer networks, to **download** means to receive data to a local system from a remote system or to initiate such a data transfer. Examples of a remote system from which a **download** might be performed include a web server, FTP server, email server, or other similar systems.

164. Ans. B.

- Hypertext Markup Language (HTML) is the standard markup language for creating web pages and web applications. With Cascading Style Sheets (CSS) and JavaScript, it forms a triad of cornerstone technologies for the World Wide Web.
- Web browsers receive HTML documents from a web server or from local storage and render them into multimedia web pages.
- HTML describes the structure of a web page semantically and originally included cues for the appearance of the document.

165. Ans. D.

**Artificial intelligence** (AI) is intelligence exhibited by machines. Artificial intelligence is applied when a machine mimics "cognitive" functions that humans

associate with other human minds, such as "learning" and "problem solving".

166. Ans. C.

An **input device** is a peripheral used to provide data and control signals to an information processing system such as a computer or information appliance. **Speaker** is the output device.

167. Ans. A.

**Downloading** is the transmission of a file from **one computer system to another**, to download a file is to request it from another computer (or from a **Web page** on another computer) and to receive it.

168. Ans. D.

A **function key** is a key on a computer or terminal keyboard which can be programmed so as to cause an operating system command interpreter or application program to perform certain actions a form of soft key.

169. Ans. B.

Batch processing is the execution of a series of programs (jobs) on a computer without manual intervention. Jobs are set up so they can be run to complete without human interaction. All input parameters are predefined through scripts, command-line arguments, control files, or job control language. Large transaction processing systems in automated organizations use Batch processing.

170. Ans. A.

**Application software** can be divided into **two** general classes: **systems software** and **applications software**. Applications software (also called end-user programs) include such things as database programs, word processors, Web browsers and spreadsheets.

171. Ans. B.

**Binary number** is a number expressed in the binary numeral system or **base-2** numeral system which represents numeric values using two different symbols, typically **0** (zero) and **1** (one).

172. Ans. D.

A **template** is pre-designed document that already has coordinating fonts, a layout, and a background. Hence, option D is correct.

173. Ans. D.

A Megabyte is 1,048,576 bytes or 1,024 Kilobytes. A megabyte is 1,000,000 bytes in decimal notation.

174. Ans. B.

The **control store** contains the set of micro-instructions that are used to execute all of the programs run that computer. The control store is referenced by the MPC (the micro-program counter) a device similar to a register.

**Note:** The MPC stores the location of the microinstruction that is currently being executed.

175. Ans. C.

Informational websites are those sites which are created in order to provide a customized and branded resource for potential and active customers, members, investors and so forth. These websites are usually content and design driven.

176. Ans. C.

If we want to see all the words **Microsoft Word** thinks you spelled wrong, Press **F7** and you'll jump to them one-by-one.

177. Ans. A.

**Subject** is the short line at the top of an **email** that tells you the subject of the message.

178. Ans. C.

Mac OS is the computer operating system for Apple Computer's Macintosh line of personal computers and workstations

179. Ans. B.

MS word find command is used to search the text or phrase in a document

180. Ans. A.

A **flowchart** is a **picture** of the separate steps of a **process** in sequential order.

181. Ans. A.

A monitor (**display**) is an **electronic visual display** for computers. A monitor usually comprises the display device.

182. Ans. E.

A **toolbar** at the top of the Microsoft Excel spreadsheet window that you can use to enter or copy an existing formula in to cells or charts. It is labeled with function symbol (fx).

**Note:** By clicking the Formula Bar, or when you type an equal (=) symbol in a cell, the Formula Bar will activate.

183. Ans. D.

File extension is used to identify **file type**, often separated from the base filename (by, e.g., a dot, a space), that indicates, e.g., the **encoding** (file format), the **usage**, of a computer file.

184. Ans. B.

An email address identifies an email box to which email messages are delivered. An email address such as **vijay@gradeup.co** is made up of a local-part, an **@symbol**, then a case-insensitive domain.

185. Ans. B.

Email spam (junk email) is a subset of **electronic spam** involving nearly identical messages sent to **numerous recipients** by email. The messages may contain disguised links that appear to be for familiar websites but in fact lead to phishing websites or sites that are hosting malware.

**Note:** Spam email may also include malware as scripts or other executable file attachments. Definitions of spam usually include the aspects that email is unsolicited and sent in bulk.

186. Ans. C.

Disk Defragmenter is a utility in Microsoft Windows designed to increase access speed by rearranging files stored on a disk to occupy contiguous storage locations, a technique called defragmentation.

**Note:** From Windows 8, the program was renamed to Defragment and Optimize Drives.

187. Ans. B.

A binary number is a combination of 0 and 1

188. Ans. D.

A program designed to **destroy data** on your computer which can travel to "**infect**" other computers is called a **virus**.

**Note:-** It is a **harmful activity** on infected hosts even rendering the computer useless.

189. Ans. D.

An electronic spreadsheet is a computer application that displays and organizes data. Each data is stored in a cell of a worksheet and can be manipulated using formulas to calculate or change the data in other cells.

190. Ans. E.

As the name implies, **multimedia** is the integration of multiple forms of media. This includes **text**, graphics, animation, **audio** and video etc.

191. Ans. C.

The **hexadecimal numeral system**, is a numeral system made up of base 16.

192. Ans. C.

A **soft copy** is the **unprinted digital document** file and a **legible version** of a piece of information not printed on a **physical medium**, especially as stored or **displayed** on a computer.

193. Ans. C.

**Universal Serial Bus** (USB) is an industry standard that defines cables, connectors and communications protocols for connection, communication, and power supply between computers and electronic devices.

194. Ans. C.

The PNG, JPEG, WMF, EMF and GIF formats are most often used to display images on the Internet.

195. Ans. C.

A **graphical user interface** (GUI) is a type of **interface** that allows users to interact with **electronic devices** through graphical icons and visual indicators such as secondary notation as opposed to **text-based** interfaces typed command labels.

196. Ans. A.

A tablet (along with smartphone) is one of the most commonly used handheld devices. It uses handheld OS like Android, iOS, Symbian etc

197. Ans. D.

HTML (**Hypertext Markup Language**) is the set of **markup symbols** inserted in a file intended for display on a World Wide Web **browser page**.

198. Ans. E.

A web browser or **browser** is a software application for **retrieving, presenting** and **traversing** information resources on the World Wide Web.

**Note:- Browsers** are primarily intended to use the **World Wide Web**, they can also be used to **access information** provided by web servers in private networks or files in file systems.

199. Ans. B.

The POP (Post Office Protocol 3) **protocol** provides a **simple**, standardized way for users to access **mailboxes** and download **messages** to their computers. When using the **POP protocol** all your **eMail messages** will be downloaded from the **mail server** to your local computer

200. Ans. B.

An email attachment is a computer file sent along with an email message. One or more files can be attached to any email message, and be sent along with it to the recipient.





# Latest Sarkari jobs, Govt Exam alerts, Results and Vacancies

- ▶ Latest News and Notification
- ▶ Exam Paper Analysis
- ▶ Topic-wise weightage
- ▶ Previous Year Papers with Answer Key
- ▶ Preparation Strategy & Subject-wise Books

To know more [Click Here](#)



[www.prepp.in](http://www.prepp.in)