

SUBJECT : PHYSICS

SECTION-A

1. If 50 Vernier divisions are equal to 49 main scale divisions of a travelling microscope and one smallest reading of main scale is 0.5 mm, the Vernier constant of travelling microscope is:

(1) 0.1 mm (2) 0.1 cm (3) 0.01 cm (4) 0.01 mm

Ans. (4)

Sol. $50V + S = 49S + S$

$S = 50(S - V)$

$.5 = 50(S - V)$

$S - V = \frac{0.5}{50} = \frac{1}{100} = 0.01 \text{ mm}$

2. A block of mass 1 kg is pushed up a surface inclined to horizontal at an angle of 60° by a force of 10 N parallel to the inclined surface as shown in figure. When the block is pushed up by 10 m along inclined surface, the work done against frictional force is : [$g = 10 \text{ m/s}^2$]

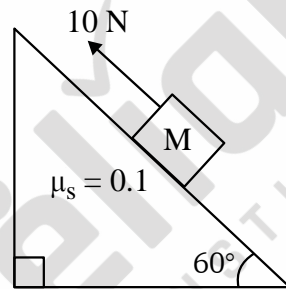

(1) $5\sqrt{3} \text{ J}$ (2) 5 J (3) $5 \times 10^3 \text{ J}$ (4) 10 J

Ans. (2)

Sol. Work done against frictional force

$= \mu N \times 10$

$= 0.1 \times 5 \times 10 = 5 \text{ J}$

3. For the photoelectric effect, the maximum kinetic energy (E_k) of the photoelectrons is plotted against the frequency (ν) of the incident photons as shown in figure. The slope of the graph gives

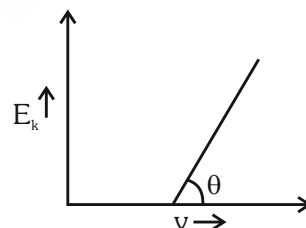

- (1) Ratio of Planck's constant to electric charge
- (2) Work function of the metal
- (3) Charge of electron
- (4) Planck's constant

Ans. (4)

Sol. $K.E. = hf - \phi$

$$\tan \theta = h$$

4. A block of ice at -10°C is slowly heated and converted to steam at 100°C . Which of the following curves represent the phenomenon qualitatively:

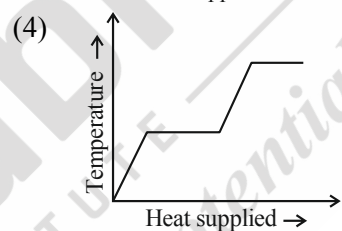
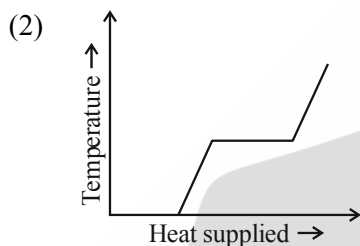
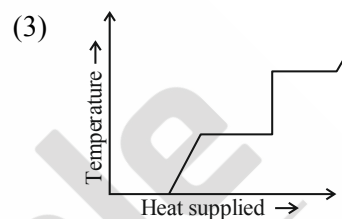
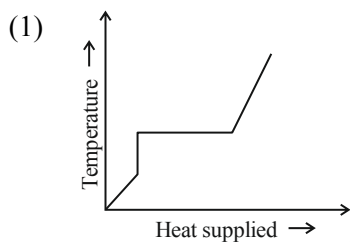

Ans. (4)

5. In a nuclear fission reaction of an isotope of mass M , three similar daughter nuclei of same mass are formed. The speed of a daughter nuclei in terms of mass defect ΔM will be :

- (1) $\sqrt{\frac{2c\Delta M}{M}}$ (2) $\frac{\Delta Mc^2}{3}$ (3) $c\sqrt{\frac{2\Delta M}{M}}$ (4) $c\sqrt{\frac{3\Delta M}{M}}$

Ans. (3)

Sol. $(X) \rightarrow (Y) + (Z) + (P)$

$$M \quad M/3 \quad M/3 \quad M/3$$

$$\Delta Mc^2 = \frac{1}{2} \frac{M}{3} v^2 + \frac{1}{2} \frac{M}{3} v^2 + \frac{1}{2} \frac{M}{3} v^2$$

$$V = c\sqrt{\frac{2\Delta M}{M}}$$

6. Choose the correct statement for processes A & B shown in figure.

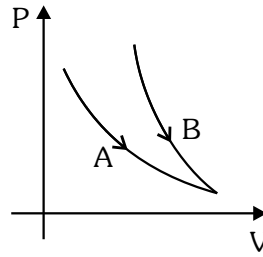

- (1) $PV^\gamma = k$ for process B and $PV = k$ for process A.
 (2) $PV = k$ for process B and A.
 (3) $\frac{P^{\gamma-1}}{T^\gamma} = k$ for process B and $T = k$ for process A.
 (4) $\frac{T^\gamma}{P^{\gamma-1}} = k$ for process A and $PV = k$ for process B.

Ans. (1 & 3)

Sol. Steeper curve (B) is adiabatic

$$\text{Adiabatic} \Rightarrow PV^\gamma = \text{const.}$$

$$\text{Or } P\left(\frac{T}{P}\right)^\gamma = \text{const.}$$

$$\frac{T^\gamma}{P^{\gamma-1}} = \text{const.}$$

Curve (A) is isothermal

$$T = \text{const.}$$

$$PV = \text{const.}$$

7. An electron revolving in n^{th} Bohr orbit has magnetic moment μ_n . If $\mu_n \propto n^x$, the value of x is:

- (1) 2 (2) 1 (3) 3 (4) 0

Ans. (2)

Sol. Magnetic moment = $i\pi r^2$

$$\mu = \frac{evr}{2}$$

$$\mu \propto \left(\frac{1}{n}\right)n^2$$

$$\mu \propto n$$

$$x = 1$$

8. An alternating voltage $V(t) = 220 \sin 100 \pi t$ volt is applied to a purely resistive load of 50Ω . The time taken for the current to rise from half of the peak value to the peak value is:

- (1) 5 ms (2) 3.3 ms (3) 7.2 ms (4) 2.2 ms

Ans. (2)

Sol. Rising half to peak

$$t = T/6$$

$$t = \frac{2\pi}{6\omega} = \frac{\pi}{3\omega} = \frac{\pi}{300\pi} = \frac{1}{300} = 3.33 \text{ ms}$$

9. A block of mass m is placed on a surface having vertical cross section given by $y = x^2/4$. If coefficient of friction is 0.5, the maximum height above the ground at which block can be placed without slipping is:

- (1) 1/4 m (2) 1/2 m (3) 1/6 m (4) 1/3 m

Ans. (1)

Sol. $\frac{dy}{dx} = \tan \theta = \frac{x}{2} = \mu = \frac{1}{2}$

$$x = 1, y = 1/4$$

10. If the total energy transferred to a surface in time t is $6.48 \times 10^5 \text{ J}$, then the magnitude of the total momentum delivered to this surface for complete absorption will be :

- (1) $2.46 \times 10^{-3} \text{ kg m/s}$ (2) $2.16 \times 10^{-3} \text{ kg m/s}$ (3) $1.58 \times 10^{-3} \text{ kg m/s}$ (4) $4.32 \times 10^{-3} \text{ kg m/s}$

Ans. (2)

Sol. $p = \frac{E}{C} = \frac{6.48 \times 10^5}{3 \times 10^8} = 2.16 \times 10^{-3}$

11. A beam of unpolarised light of intensity I_0 is passed through a polaroid A and then through another polaroid B which is oriented so that its principal plane makes an angle of 45° relative to that of A. The intensity of emergent light is :

- (1) $I_0/4$ (2) I_0 (3) $I_0/2$ (4) $I_0/8$

Ans. (1)

Sol. Intensity of emergent light

$$= \frac{I_0}{2} \cos^2 45^\circ = \frac{I_0}{4}$$

12. Escape velocity of a body from earth is 11.2 km/s. If the radius of a planet be one-third the radius of earth and mass be one-sixth that of earth, the escape velocity from the planet is:

- (1) 11.2 km/s (2) 8.4 km/s (3) 4.2 km/s (4) 7.9 km/s

Ans. (4)

Sol. $R_p = \frac{R_E}{3}, M_p = \frac{M_E}{6}$

$$V_e = \sqrt{\frac{2GM_e}{R_e}} \quad \dots(i)$$

$$V_p = \sqrt{\frac{2GM_p}{R_p}} \quad \dots(ii)$$

$$\frac{V_e}{V_p} = \sqrt{2}$$

$$V_p = \frac{V_e}{\sqrt{2}} = \frac{11.2}{\sqrt{2}} = 7.9 \text{ km/sec}$$

13. A particle of charge ‘-q’ and mass ‘m’ moves in a circle of radius ‘r’ around an infinitely long line charge of linear density ‘+λ’. Then time period will be given as:

(Consider k as Coulomb’s constant)

- (1) $T^2 = \frac{4\pi^2 m}{2k\lambda q} r^3$ (2) $T = 2\pi r \sqrt{\frac{m}{2k\lambda q}}$ (3) $T = \frac{1}{2\pi r} \sqrt{\frac{m}{2k\lambda q}}$ (4) $T = \frac{1}{2\pi} \sqrt{\frac{2k\lambda q}{m}}$

Ans. (2)

Sol. $\frac{2k\lambda q}{r} = m\omega^2 r$

$$\omega^2 = \frac{2k\lambda q}{mr^2}$$

$$\left(\frac{2\pi}{T}\right)^2 = \frac{2k\lambda q}{mr^2}$$

$$T = 2\pi r \sqrt{\frac{m}{2k\lambda q}}$$

14. If mass is written as $m = k c^P G^{-1/2} h^{1/2}$ then the value of P will be : (Constants have their usual meaning with k a dimensionless constant)

- (1) 1/2 (2) 1/3 (3) 2 (4) -1/3

Ans. (1)

Sol. $m = k c^P G^{-1/2} h^{1/2}$

$$M^1 L^0 T^0 = [L T^{-1}]^P [M^{-1} L^3 T^{-2}]^{-1/2} [M L^2 T^{-1}]^{1/2}$$

By comparing $P = 1/2$

15. In the given circuit, the voltage across load resistance (R_L) is:

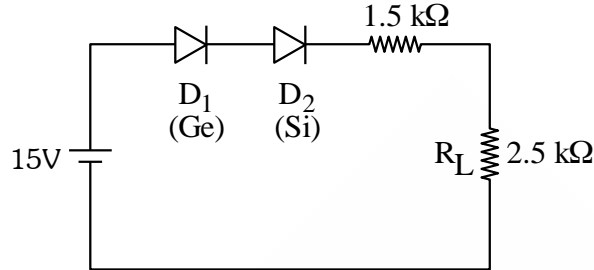

- (1) 8.75 V (2) 9.00 V (3) 8.50 V (4) 14.00 V

Ans. (1)

Sol.

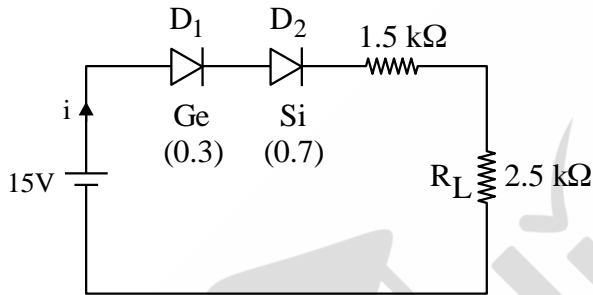

$$i = \frac{14}{4} = 3.5 \text{ mA}$$

$$V_L = iR_L = 3.5 \times 2.5 \text{ volt} = 8.75 \text{ volt}$$

16. If three moles of monoatomic gas ($\gamma = \frac{5}{3}$) is mixed with two moles of a diatomic gas ($\gamma = \frac{7}{5}$), the value of adiabatic exponent γ for the mixture is:

- (1) 1.75 (2) 1.40 (3) 1.52 (3) 1.35

Ans. (3)

Sol. $f_1 = 3, \quad f_2 = 5$

$n_1 = 3, \quad n_2 = 2$

$$f_{\text{mixture}} = \frac{n_1 f_1 + n_2 f_2}{n_1 + n_2} = \frac{9 + 10}{5} = \frac{19}{5}$$

$$\gamma_{\text{mixture}} = 1 + \frac{2 \times 5}{19} = \frac{29}{19} = 1.52$$

17. Three blocks A, B and C are pulled on a horizontal smooth surface by a force of 80 N as shown in figure

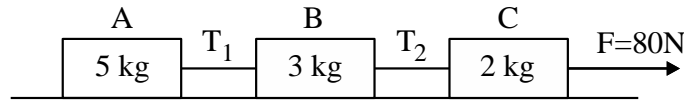

The tensions T_1 and T_2 in the string are respectively:

- (1) 40N, 64N (2) 60N, 80N (3) 88N, 96N (4) 80N, 100N

Ans. (1)

Sol. $a_A = a_B = a_C = \frac{F}{5+3+2} = \frac{80}{10} = 8 \text{ m/s}^2$

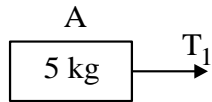

$$T_1 = 5 \times 8 = 40$$

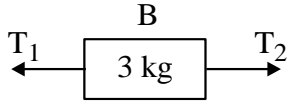

$$T_2 - T_1 = 3 \times 8 \Rightarrow T_2 = 64$$

18. When a potential difference V is applied across a wire of resistance R , it dissipates energy at a rate W . If the wire is cut into two halves and these halves are connected mutually parallel across the same supply, the energy dissipation rate will become:

- (1) $1/4W$ (2) $1/2W$ (3) $2W$ (4) $4W$

Ans. (4)

Sol. $\frac{v^2}{R} = W \dots(i)$

$$\frac{v^2}{\frac{1}{2}\left(\frac{R}{2}\right)} = W' \dots(ii)$$

From (i) & (ii), we get

$$W' = 4W$$

19. Match List I with List II

List-I		List-II	
A.	Gauss's law of magnetostatics	I.	$\oint \vec{E} \cdot \vec{da} = \frac{1}{\epsilon_0} \int \rho dV$
B.	Faraday's law of electro magnetic induction	II.	$\oint \vec{B} \cdot \vec{da} = -0$
C.	Ampere's law	III.	$\oint \vec{E} \cdot \vec{dl} = \frac{-d}{dt} \int \vec{B} \cdot \vec{da}$
D.	Gauss's law of electrostatics	IV.	$\oint \vec{B} \cdot \vec{dl} = -\mu_0 I$

Choose the correct answer from the options given below:

(1) A-I, B-III, C-IV, D-II

(2) A-III, B-IV, C-I, D-II

(3) A-IV, B-II, C-III, D-I

(4) A-II, B-III, C-IV, D-I

Ans. (4)

Sol. Maxwell's equation

20. Projectiles A and B are thrown at angles of 45° and 60° with vertical respectively from top of a 400 m high tower. If their ranges and times of flight are same, the ratio of their speeds of projection $v_A : v_B$ is :

(1) $1 : \sqrt{3}$

(2) $\sqrt{2} : 1$

(3) $1 : 2$

(4) $1 : \sqrt{2}$

Ans. (Bonus)

Sol.

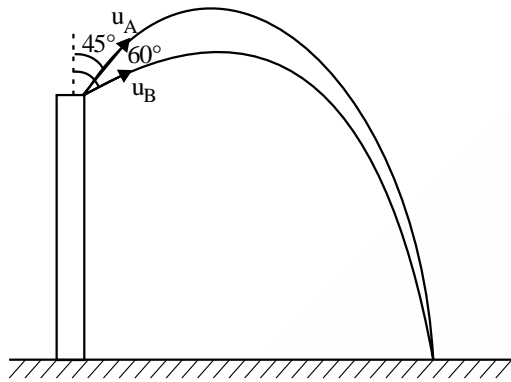

For u_A & u_B time of flight and range can not be same. So above options are incorrect.

Section-B

21. A power transmission line feeds input power at 2.3 kV to a step down transformer with its primary winding having 3000 turns. The output power is delivered at 230 V by the transformer. The current in the primary of the transformer is 5A and its efficiency is 90%. The winding of transformer is made of copper. The output current of transformer is _____ A.

Ans. (45)

Sol. $P_i = 2300 \times 5$ watt

$$P_0 = 2300 \times 5 \times 0.9 = 230 \times I_2$$

$$I_2 = 45A$$

22. A big drop is formed by coalescing 1000 small identical drops of water. If E_1 be the total surface energy of 1000 small drops of water and E_2 be the surface energy of single big drop of water, the $E_1 : E_2$ is $x : 1$ where $x =$ _____.

Ans. (10)

Sol. $\rho \left(\frac{4}{3} \pi r^3 \right) 1000 = \frac{4}{3} \pi R^3 \rho$

$R = 10r$

$E_1 = 1000 \times 4\pi r^2 \times S$

$E_2 = 4\pi (10r)^2 S$

$\frac{E_1}{E_2} = \frac{10}{1}, x = 10$

- 23.** Two discs of moment of inertia $I_1 = 4 \text{ kg m}^2$ and $I_2 = 2 \text{ kg m}^2$ about their central axes & normal to their planes, rotating with angular speeds 10 rad/s & 4 rad/s respectively are brought into contact face to face with their axis of rotation coincident. The loss in kinetic energy of the system in the process is _____ J.

Ans. (24)

Sol. $I_1 \omega_1 + I_2 \omega_2 = (I_1 + I_2) \omega_0$ (C.O.A.M.)

gives $\omega_0 = 8 \text{ rad/s}$

$E_1 = \frac{1}{2} I_1 \omega_1^2 + \frac{1}{2} I_2 \omega_2^2 = 216 \text{ J}$

$E_2 = \frac{1}{2} (I_1 + I_2) \omega_0^2 = 192 \text{ J}$

$\therefore \Delta E = 24 \text{ J}$

- 24.** In an experiment to measure the focal length (f) of a convex lens, the magnitude of object distance (x) and the image distance (y) are measured with reference to the focal point of the lens. The y-x plot is shown in figure.

The focal length of the lens is _____ cm.

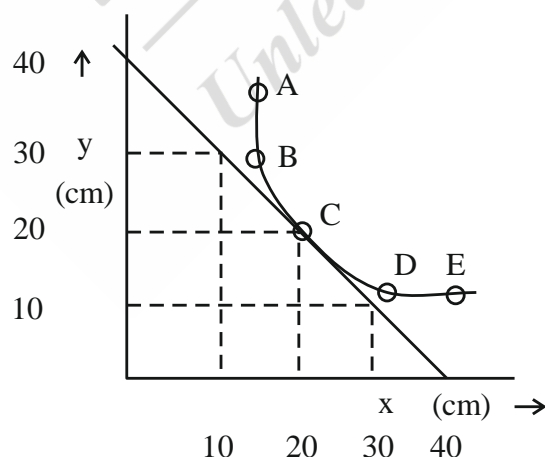

Ans. (20)

Sol. $\frac{1}{f+20} - \frac{1}{-(f+20)} = \frac{1}{f}$

$$\frac{2}{f+20} = \frac{1}{f} \quad f = 20\text{cm}$$

Or $x_1x_2 = f^2$ gives $f = 20\text{ cm}$

25. A vector has magnitude same as that of $\vec{A} = 3\hat{j} + 4\hat{j}$ and is parallel to $\vec{B} = 4\hat{i} + 3\hat{j}$. The x and y components of this vector in first quadrant are x and 3 respectively where $x =$ _____.

Ans. (4)

Sol. $\vec{N} = |\vec{A}| \hat{B} = \frac{5(4\hat{i} + 3\hat{j})}{5} = 4\hat{i} + 3\hat{j}$

$\therefore x = 4$

26. The current of 5A flows in a square loop of sides 1 m is placed in air. The magnetic field at the centre of the loop is $X\sqrt{2} \times 10^{-7}\text{ T}$. The value of X is _____.

Ans. (40)

Sol. $B = 4 \times \frac{\mu_0 i}{4\pi \left(\frac{1}{2}\right)} \left(\frac{1}{\sqrt{2}} + \frac{1}{\sqrt{2}}\right)$
 $= 4 \times 10^{-7} \times 5 \times 2 \times \sqrt{2}$
 $= 40\sqrt{2} \times 10^{-7}\text{ T}$

27. Two identical charged spheres are suspended by string of equal lengths. The string make an angle of 37° with each other. When suspended in a liquid of density 0.7 g/cm^3 , the angle remains same. If density of material of the sphere is 1.4 g/cm^3 , the dielectric constant of the liquid is _____

$$\left(\tan 37^\circ = \frac{3}{4} \right).$$

Ans. (2)

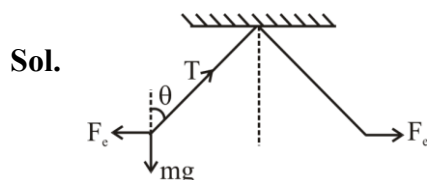

$$T \cos \theta = mg$$

$$T \sin \theta = F_e$$

$$\tan\theta = \frac{F_e}{mg}$$

$$\tan\theta = \frac{F_e}{\rho_B Vg} \quad \dots(i)$$

$$\tan\theta = \frac{F_e}{\frac{k}{(\rho_B - \rho_L)Vg}} \quad \dots(ii)$$

From Eq. (i) & (ii)

$$\rho_B Vg = (\rho_B - \rho_L)kVg$$

$$1.4 = 0.7 k$$

$$k = 2$$

28. A simple pendulum is placed at a place where its distance from the earth's surface is equal to the radius of the earth. If the length of the string is 4m, then the time period of small oscillations will be _____ s. [take $g = \pi^2 \text{ ms}^{-2}$]

Ans. (8)

Sol. Acceleration due to gravity $g' = \frac{g}{4}$

$$T = 2\pi\sqrt{\frac{4\ell}{g}}$$

$$T = 2\pi\sqrt{\frac{4 \times 4}{g}}$$

$$T = 2\pi\frac{4}{\pi} = 8\text{s}$$

29. A point source is emitting sound waves of intensity $16 \times 10^{-8} \text{ Wm}^{-2}$ at the origin. The difference in intensity (magnitude only) at two points located at a distances of 2m and 4m from the origin respectively will be _____ $\times 10^{-8} \text{ Wm}^{-2}$.

Ans. (Bonus)

Sol. Question is wrong as data is incomplete.

30. Two resistance of $100\ \Omega$ and $200\ \Omega$ are connected in series with a battery of $4\ \text{V}$ and negligible internal resistance. A voltmeter is used to measure voltage across $100\ \Omega$ resistance, which gives reading as $1\ \text{V}$. The resistance of voltmeter must be _____ Ω .

Ans. (200)

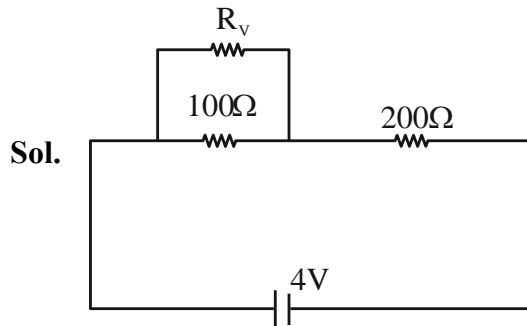

$$\frac{R_v \cdot 100}{R_v + 100} = \frac{200}{3}$$

$$3R_v = 2R_v + 200$$

$$R_v = 200$$

Reliable
INSTITUTE
Unleashing Potential